

Prosthetics Catalog

The complete program.



Edition 23

Prosthetics Catalog

The complete program.

Ceramics	Grey
CAD/CAM materials	Teal
Crowns and bridges	Dark Blue
Implantology	Dark Blue
Cast partial denture	Orange
Finishing	Yellow
Prosthetics	Cyan
Wires Clasps	Dark Blue
Expansion screws	Green
Orthodontic acrylics	Pink
Pliers Instruments	Dark Blue
Equipment	Dark Red
Knowledge	Dark Blue
Courses and Events	Light Grey
Service	Dark Blue

"For the one thing that remains is change and the only way forward is to be part of this change."

*(Michael Richter
(*1952), German
contemporary historian)*

Customer number

Please enter your Dentaforum customer number here. For faster service, we kindly ask you to use your customer number when ordering.

Dear Customer,

For more than 130 years, the name Dentaaurum has stood for outstanding quality, continuous innovation and a high level of responsibility. We place the highest demands on the quality of our products, from the purchase of raw materials to the packaged product.

As an owner-managed family company, we are independent and flexible. We place clear focus on Germany as our location, creating and maintaining jobs, and thereby contribute to securing a sound economic future. We work on the principle: „Made in Germany“. This is true for our departments Research and Development, Production and Logistics. We focus on the latest development and manufacturing methods worldwide and often set new standards.

The traditional world of prosthetics is undergoing unprecedented changes due to new technologies and materials.

Ceramics is a field we are particularly keen to develop and developments in our ceraMotion® line clearly demonstrate the move from veneering ceramics towards all-ceramic systems. A new lithium-disilicate ceramic for the press technique together with an unusual press investment material are examples of new, economically practical paths in dental prosthetics. A quick, aesthetic finish to all-ceramic restorations can now be achieved with 2D and 3D pastes that have been carefully coordinated with the ceramic material.

These changes can also be seen with our remanium® alloys. We are now offering milling blanks or powder for the SLM technology in the same high Dentaaurum quality alongside the traditional casting alloys.

Our aim for the future is to continue along the path of digitization, to embrace the changes this will bring and to be open for new innovative ideas. For the one thing that remains is change and the only way forward is to be part of this change.

Best regards from Ispringen,



Mark Stephen Pace
CEO Dentaaurum Group



Axel Winkelstroeter
CEO Dentaaurum Group

Dentaurum Group

Germany | Benelux | España | France | Italia | Switzerland | Australia | Canada | USA
and in more than 130 countries worldwide.



Dental technologies that set standards.

The Dentaurum Group develops, produces and sells dental products and services worldwide. The Dentaurum Group has played an active role in the dental sector for more than 130 years as an owner-managed family company with its headquarters in Ispringen (near Pforzheim, Northern Black Forest), Germany.

Experience Dentaurum by taking a virtual tour in a 360° perspective. There is a total of five 360° viewpoints which give you a fantastic overview.





Orthodontics

Implantology

Prosthetics

Ceramics



Photo: © Christian Fehrer

High-tech in-house.



There is a high level of professional knowledge in our company that has been built up over the years in our own research and development facilities, both in Germany and in France. Highly qualified employees work together in interdisciplinary teams to find answers to the challenges the future poses. At the same time, long-standing co-operations with experts from universities and clinics contribute to finding new developments and innovations.

A further result of these efforts: a comprehensive product portfolio which is one of Dentaureum's strengths. No other dental company has such an extensive range of products offering a total of more than 8500 articles.





Dentaurum Online Shop.

Order easily online.

Your advantages:

- Detailed product information.
 - Product availability is automatically checked.
 - Individualized list of articles frequently ordered.
 - Your terms and prices are displayed.
 - Secure internet connection with SSL encryption.
 - Determine the delivery date of your order.
-
- shop.dentaurum.de ➤ Germany and Austria
 - shop.dentaurum.ch ➤ Switzerland
 - shop.dentaurum.be ➤ Benelux
 - shop.dentaurum.es ➤ Spain
 - shop.dentaurum.fr ➤ France
 - shop.dentaurum.it ➤ Italy
 - shop.dentaurum.us ➤ USA

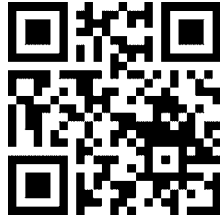

ONLINE SHOP

shop.dentaurum.com



Your direct contact.

We are happy to be of service.



D
DENTAURUM

Telephone	+4972 31/803-0
Fax	+4972 31/803-295
Email	info@dentaurum.com

D
DENTAURUM
AUSTRALIA

Telephone	+61 2 97 43 48 11
Fax	+61 2 97 43 45 99
Email	info@dentaurum.com.au

D
DENTAURUM
CANADA

Telephone	+1-800-363-9973
Fax	+1-888-771-3640
Email	info@dentaurum.ca

D
DENTAURUM
USA

Telephone	+1-800-523-3946
Fax	+1-800-553-6389
Email	info@dentaurum-us.com



Contents

■	Ceramics	18–119
■	Ceramic in paste form	20–25
	ceraMotion® One Touch	22–25
■	Press ceramic	26–35
	ceraMotion® LiSi – press ceramic	28–29
	ceraMotion® PZr – press-on ceramic	30–31
	ceraMotion® P+PMe – press and press-on ceramic	32–33
	ceraMotion® – press ceramic accessories	34
■	Veneering ceramic	36–119
	ceraMotion® Zr – zirconium oxide ceramic	38–57
	ceraMotion® Me – metal ceramic	58–82
	ceraMotion® Ti – titanium ceramic	84–102
	ceraMotion® Lf – low-fusing ceramic	104–115
	ceraMotion® – ceramics accessories	116–118
■	CAD/CAM materials	120–141
	CoCr blanks	126–127
	Titanium blanks	128–129
	Wax blanks	130
	Zirconium oxide blanks	131–135
	Zirconium oxide / Coloring liquids	136–138
	Zirconium oxide – accessories	139–140
■	Crowns and bridges	142–189
	CoCr alloys	156–162
	NiCr alloys	163–165
	Titanium	166–167
	Solders and welding wires	168–171
	Attachments and accessories	172
	Investment materials	173–180
	Waxes	181–184
	Investment systems	185–186
	Modelling accessories	187
	Accessories	188–189
■	Implantology	
	tioLogic® TWINFIT – implant system	190–195
■	Cast partial dentures	196–245
	Alloys	208–211
	Titanium	212–213
	Solders and welding wires	214–215
	Investment materials	216–221
	Fine investment materials	222
	Duplicating materials	223–227
	Duplicating materials – accessories	228–231
	Waxes	232–237
	Accessories	238–244

Finishing	246–273
Separating and grinding discs	250–252
Grinding points	253–254
Burs and cutters	255–258
Diamond burs	259–263
Mandrels	264
Polishing tools and accessories	265–271
rematitan® finishing kit	272
Prosthetics	274–283
Impression materials	278
Laboratory accessories	279
Isolation and waxes	280
Grid strengtheners	281
Accessories	282–283
Wires Clasps	284–295
Wires	288–291
Clasps	292–295
Expansion screws	296–325
Standard expansion screws	300–304
Special expansion screws	305–314
Variety expansion screws	315–318
RPE screws	319–323
Accessories	324–325
Orthodontic acrylics	326–349
Orthocryl® LC / Starter sets / Single packs / Accessories	332–334
Orthocryl® / Assortments	335
Orthocryl® / Single packs	336–337
Disco glitter	338
Decals	339–342
Accessories	343–347
Appliance containers and accessories	348–349
Pliers Instruments	350–361
Premium-Line pliers	354–357
Pliers / Instruments	358–359
Accessories	360

Contents

Equipment	362–393
Welding units and accessories	368–379
Casting unit and accessories	380–383
Surveying equipment and accessories	384–386
Electric wax knife	387–388
Model trimmer and accessories	389
Pressure vessel and suction unit	390
Blasting abrasive	391
Miscellaneous	392
Knowledge	394–405
remanium® kompendium	396–397
o-atlas II	398–399
Online media library	400–401
Download center	402–403
Social media	404–405
Courses and Events	406–411
CDC – Centrum Dentale Kommunikation	408–409
Courses and Events	410–411
Service	412–439
Service and hotline numbers	11
Conversion charts	414
Environment	416–417
Alphabetical index	418–424
Numerical index	426–437
Disclaimer / Image credits	439

ceraMotion® One Touch	Page	22
ceraMotion® LiSi – press ceramic	Page	28
ceraMotion® PZr – press-on ceramic	Page	30
ceraMotion® P+PMe – press and press-on ceramic	Page	32
ceraMotion® – press ceramic accessories	Page	34
ceraMotion® Zr – zirconium oxide ceramic	Page	38
ceraMotion® Me – metal ceramic	Page	58
ceraMotion® Ti – titanium ceramic	Page	84
ceraMotion® Lf – low-fusing ceramic	Page	104
ceraMotion® – ceramic accessories	Page	116



ceraMotion®

The complete ceramic system.



Photo: © Christian Ferrari®

DENTAURUM
**ONLINE
SHOP**
shop.dentaurum.com



ceraMotion®
One Touch



*Pastes
2D & 3D...*

The aesthetic finish for monolithic all-ceramic restorations.

ceraMotion® One Touch are 2D and 3D pastes that have been specially developed for the finish and characterization of all-ceramic monolithic restorations made of lithium disilicate and zirconium oxide.

Easy

Ready to use.

Quick

All in only one firing.

Aesthetic

Natural in-depth effect without complicated layering.



ceraMotion® 2D pastes.

The small particle size in combination with the translucency of the masses helps optimize the color of the tooth, the brightness value and the in-depth effect of all-ceramic restorations.

- The translucency of the 2D pastes maintains the light dynamics.
- The fluorescence of the pastes was adapted to lend a natural appearance also to all-ceramic restorations.
- Maximum aesthetics thanks to color-coordinated pastes with 3D effect.

ceraMotion® 3D pastes.

- By joining slightly larger ceramic particles with a thixotropic paste, it is possible to shape the incisal area and the occlusal surface area and to add contact points precisely.
- The 3D pastes have a firing stability which guarantees that the desired morphology is maintained.
- The translucency and the opalescence of the ready-made 3D incisal masses create an in-depth effect which appears authentic.
- The pastes' fluorescence was adapted to the fluorescence of natural teeth.



Ceramic in paste form

ceraMotion® – One Touch
One Touch

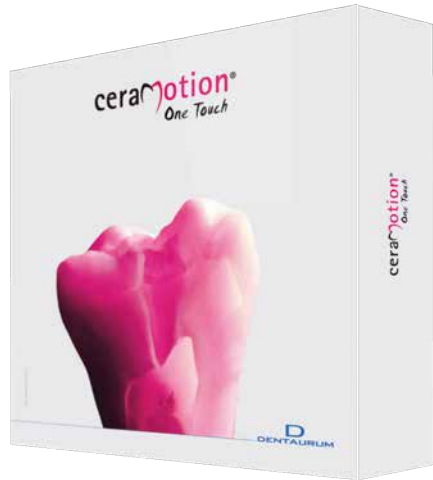

ceraMotion® One Touch Set

- set specially assorted for the easy finishing of aesthetic, fully anatomical restorations.
- fast and easy handling thanks to ready-mixed ceramic pastes.

REF 250-800-70

1 set

CE 0483

Contents:

Designation	REF	Quantity
Paste Glaze PGL transpa	250-271-03	3 g
Paste 3D P 3D I2	250-300-03	3 g
Paste 3D P 3D lumin	250-301-03	3 g
Paste 3D P 3D neutral	250-302-03	3 g
Paste 3D P 3D opal blue	250-303-03	3 g
Paste 3D P 3D opal grey	250-304-03	3 g
Paste 3D P 3D opal honey	250-305-03	3 g
Paste 2D P 2D A	250-306-03	3 g
Paste 2D P 2D B	250-307-03	3 g
Paste 2D P 2D C	250-308-03	3 g

Designation	REF	Quantity
Paste 2D P 2D D	250-309-03	3 g
Paste 2D P 2D white	250-310-03	3 g
Paste 2D P 2D grey	250-311-03	3 g
Paste 2D P 2D honey	250-312-03	3 g
Paste 2D P 2D blue	250-313-03	3 g
Paste 2D P 2D violet	250-314-03	3 g
Diluting Liquid	254-012-01	10 ml
Refreshing Liquid	254-014-01	10 ml
2D Brush	260-905-20	1 piece
3D Brush	260-906-20	1 piece

ceraMotion® One Touch Paste 2D P 2D

Finishing glaze pastes to achieve required V-color A-D / for individual characterization as required.
It is possible to work with the 3D pastes without intermediate firing. 2D pastes can be used to determine the degree of brightness individually: white (lighter), grey (darker).



Color	REF	Quantity
A	250-306-03	3 g
B	250-307-03	3 g
C	250-308-03	3 g
D	250-309-03	3 g
white	250-310-03	3 g
grey	250-311-03	3 g
honey	250-312-03	3 g
blue	250-313-03	3 g
violet	250-314-03	3 g

CE 0483

ceraMotion® One Touch Paste 3D P 3D

- incisal 3D pastes for minimum layering and in-depth effect (3D paste I2 + lumin).
- a neutral 3D paste with increased transparency to modify the 3D incisal pastes (3D paste neutral).
- color-coordinated 3D pastes with an opalescent effect for individualization (3D paste opal blue, opal grey, opal honey).



Color	REF	Quantity
I2	250-300-03	3 g
lumin	250-301-03	3 g
neutral	250-302-03	3 g
opal blue	250-303-03	3 g
opal grey	250-304-03	3 g
opal honey	250-305-03	3 g

CE 0483

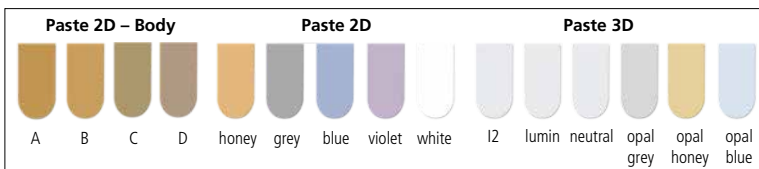

Ceramic in paste form

ceramotion® – One Touch
One Touch



ceramotion® One Touch Paste 3D Gingival

Color	REF	Quantity
Gingival 1	250-330-03	3 g
Gingival 2	250-331-03	3 g
Gingival 3	250-332-03	3 g
Gingival 4	250-333-03	3 g
Gingival Modifier	250-336-03	3 g
Gingival white	250-334-03	3 g
Gingival transpa	250-335-03	3 g

CE 0483

NEW



Paste Glaze PGL

Glaze material in paste form.

Particularly suitable for monolithic restorations made of zirconium oxide and lithium disilicate.

- fluorescent
- can be applied precisely



Color	REF	Quantity
transpa	250-271-03	3 g

CE 0483

Diluting Liquid

To mix the ceraMotion® One Touch 2D and 3D pastes.

REF 254-012-01	10 ml
----------------	-------



Refreshing Liquid

To adjust the viscosity without affecting the stability of the ceraMotion® One Touch 3D pastes.

REF 254-014-01	10 ml
----------------	-------



2D Brush

Brush for application of 2D pastes.

REF 260-905-20	1 piece
----------------	---------



3D Brush

Brush for application of 3D pastes.

REF 260-906-20	1 piece
----------------	---------



ceraMotion® One Touch Display

Display with mixing plate for ceraMotion® One Touch (without content).

REF 250-350-00	1 piece
----------------	---------

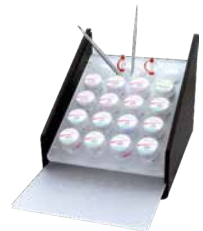

ceraMotion®
LiSi



ceraMotion® LiSi.

ceraMotion® LiSi is a lithium disilicate press ceramic that harmonizes perfectly with ceraMotion® veneering ceramics and the innovative ceraMotion® One Touch finishing pastes.

This press ceramic system stands out as being more efficient than the average. Lithium disilicate is also a particularly strong material and highly aesthetic.

Combined in the right way with ceraMotion® press invest, an investment material specially coordinated for the system, surfaces can be created that are exceptionally smooth and homogeneous from the press pellets that were developed at Dentaureum.

The result: aesthetic restorations, easy and fast.



Excellent results thanks to the coordinated press investment material.

First-class, homogeneous press results can be achieved with a process that is fast and involves a minimum of effort.

Compact product range with low stock levels.

Although the system is capable of covering the Vita 3D-Master®* shade range, the amount of shades and translucencies required remains economically viable.

Simple to finish with ceraMotion® One Touch.

By using the right finishing pastes, it is possible to quickly achieve a result that is very natural with only one firing.

Amazing aesthetic results for monolithic crowns.

Exceptionally good aesthetic results can be achieved for all-ceramic pressed restorations with the right combination of translucency, opalescence and fluorescence.

* Vita 3D-Master® is a registered trademark of Vita Zahnfabrik H. Rauter GmbH & Co.KG, 79704 Bad Säckingen, Germany.

Press ceramics

ceraMotion® – Press ceramic LiSi



ceraMotion® LiSi Ingots HT

ø 13 mm

High Translucency

- high-strength lithium disilicate ceramic
- press ingots for pressing inlays, onlays, veneers, crowns and three unit bridges in anterior and bicuspid area.
Transparent, slightly colored ingots, similar to enamel.

Color	REF	Quantity
HT 1	255-041-05	5 x 3 g
HT 2	255-042-05	5 x 3 g

CE 0483

HT 1 = transparency similar to tooth enamel – light
HT 2 = transparency similar to tooth enamel – slightly colored

NEW



ceraMotion® LiSi Ingots LT

ø 13 mm

Low Translucency

- high-strength lithium disilicate ceramic
- press ingots for pressing inlays, onlays, veneers, crowns and three unit bridges in anterior and bicuspid area

Color	REF	Quantity
LT A1	255-001-05	5 x 3 g
LT A2	255-002-05	5 x 3 g
LT A3	255-003-05	5 x 3 g
LT A3,5	255-035-05	5 x 3 g
LT A4	255-004-05	5 x 3 g
LT B2	255-012-05	5 x 3 g
LT B3	255-013-05	5 x 3 g
LT C2	255-022-05	5 x 3 g
LT C3	255-023-05	5 x 3 g
LT D3	255-033-05	5 x 3 g

CE 0483

NEW

ceraMotion® LiSi Ingots LT

∅ 13 mm

Low Translucency

- high-strength lithium disilicate ceramic
- for replication of the Vita 3D-Master®** shades
- press ingots for pressing inlays, onlays, veneers, crown and three unit bridges in anterior and bicuspid area



Color	Vita 3D-Master®**	REF	Quantity
LT 02	OM2	255-102-05	5 x 3 g
LT 11	1M1	255-111-05	5 x 3 g
LT 12	1M2	255-112-05	5 x 3 g
LT 21	2M1	255-121-05	5 x 3 g
LT 22	2M2	255-122-05	5 x 3 g
LT 23	2M3	255-123-05	5 x 3 g
LT 31	3M1	255-131-05	5 x 3 g
LT 32	3M2	255-132-05	5 x 3 g
LT 33	3M3	255-133-05	5 x 3 g
LT 41	4M1	255-141-05	5 x 3 g
LT 42	4M2	255-142-05	5 x 3 g

CE 0483

* Vita 3D-Master® is a registered trademark of Vita Zahnfabrik H. Rauter GmbH & Co.KG, 79704 Bad Säckingen, Germany.

NEW

DENTAURUM
**ONLINE
SHOP**
shop.dentaurum.com



ceraMotion® pZr – Press-on ceramic



Press Liner PZr L

For use on white ZrO₂ as color base.

- for shade optimization with colored ZrO₂
- produces natural fluorescence in the veneer

Liquid: Powder BOL Liquid

Shade code	REF	Quantity
PZr L A1	250-401-20	20 g
PZr L A2	250-402-20	20 g
PZr L A3	250-403-20	20 g
PZr L A3,5	250-404-20	20 g
PZr L A4	250-405-20	20 g
PZr L B1	250-406-20	20 g
PZr L B2	250-407-20	20 g
PZr L B3	250-408-20	20 g
PZr L B4	250-409-20	20 g
PZr L C1	250-410-20	20 g
PZr L C2	250-411-20	20 g
PZr L C3	250-412-20	20 g
PZr L C4	250-413-20	20 g
PZr L D2	250-414-20	20 g
PZr L D3	250-415-20	20 g
PZr L D4	250-416-20	20 g

CE 0483

Ingot PZr I

ø 12 mm

Press ingots for pressing on zirconia frameworks.

Shade code	REF	Quantity
PZr I A1	250-431-05	5 x 2 g
PZr I A2	250-432-05	5 x 2 g
PZr I A3	250-433-05	5 x 2 g
PZr I A3,5	250-434-05	5 x 2 g
PZr I A4	250-435-05	5 x 2 g
PZr I B1	250-436-05	5 x 2 g
PZr I B2	250-437-05	5 x 2 g
PZr I B3	250-438-05	5 x 2 g
PZr I B4	250-439-05	5 x 2 g
PZr I C1	250-440-05	5 x 2 g
PZr I C2	250-441-05	5 x 2 g
PZr I C3	250-442-05	5 x 2 g
PZr I C4	250-443-05	5 x 2 g
PZr I D2	250-444-05	5 x 2 g
PZr I D3	250-445-05	5 x 2 g
PZr I D4	250-446-05	5 x 2 g



CE 0483

ceraMotion® P.PMe – Press and press-on ceramic



Paste Opaque PO

Opaque paste

- can be universally used with all non-precious and precious metal alloys in the conventional CTE range, as well as for galvano gold and press-on technique
- maximum bonding strength due to TRC bonding (Tension Reduced Connection)
- good, dense coverage of the metal substructure
- easy, uncomplicated application

Liquid: Paste Liquid

Shade code	REF	Quantity
PO A1	252-501-03	3 g
PO A2	252-502-03	3 g
PO A3	252-503-03	3 g
PO A3,5	252-504-03	3 g
PO A4	252-505-03	3 g
PO B1	252-506-03	3 g
PO B2	252-507-03	3 g
PO B3	252-508-03	3 g
PO B4	252-509-03	3 g
PO C1	252-510-03	3 g
PO C2	252-511-03	3 g
PO C3	252-512-03	3 g
PO C4	252-513-03	3 g
PO D2	252-514-03	3 g
PO D3	252-515-03	3 g
PO D4	252-516-03	3 g

CE⁰⁴⁸³

Press and press-on ceramic – ceraMotion® P-PMe

Ingot PMe I

ø 12 mm

Press ingots for pressing on to metal, for pressing all-ceramic crowns.

Shade code	REF	Quantity
PMe I A1	252-431-05	5 x 2 g
PMe I A2	252-432-05	5 x 2 g
PMe I A3	252-433-05	5 x 2 g
PMe I A3,5	252-434-05	5 x 2 g
PMe I A4	252-435-05	5 x 2 g
PMe I B1	252-436-05	5 x 2 g
PMe I B2	252-437-05	5 x 2 g
PMe I B3	252-438-05	5 x 2 g
PMe I B4	252-439-05	5 x 2 g
PMe I C1	252-440-05	5 x 2 g
PMe I C2	252-441-05	5 x 2 g
PMe I C3	252-442-05	5 x 2 g
PMe I C4	252-443-05	5 x 2 g
PMe I D2	252-444-05	5 x 2 g
PMe I D3	252-445-05	5 x 2 g
PMe I D4	252-446-05	5 x 2 g



CE 0483

Ingot P I

ø 12 mm

Press ingots for pressing veneers, inlays, onlays.

Shade code	REF	Quantity
P I T1	252-451-05	5 x 2 g
P I T2	252-452-05	5 x 2 g
P I CT1: A1; A2; B1; B2; C1; C2	252-456-05	5 x 2 g
P I CT2: A3; A3,5; B3; C3	252-457-05	5 x 2 g
P I CT3: A4; B4; D4	252-458-05	5 x 2 g



CE 0483

T1 = transparent ingot / T2 = slightly less transparent ingot
CT1 / CT2 / CT3 = transparency similar to tooth enamel, slightly colored ingots

DENTAURUM
ONLINE SHOP
shop.dentaurum.com



ceraMotion® – Press ceramic accessories



Ring former

Used for \varnothing 12 mm press plunger.

Special ring former with silicone ring included for press ceramic investing procedures.

The silicone ring enables the casting ring to be easily removed after the investment has set.

Capacity	REF	Quantity
100 g	260-360-10	1 piece
200 g	260-360-20	1 piece



Press plunger

\varnothing 12 mm

Reusable aluminium oxide press plunger.

REF 260-365-01	1 piece
-----------------------	---------



Disposable press plunger

\varnothing 12 mm

Disposable investment press plunger for single use.

No time-consuming cleaning of the press plunger.

REF 260-365-05	20 pieces
-----------------------	-----------



Disposable press plunger

\varnothing 13 mm

Investment press plunger for single use. No time-consuming cleaning of the press plunger.

Used with lithium disilicate ceramic (e.g. ceraMotion® LiSi).

REF 260-365-13	20 pieces
-----------------------	-----------





NEW

ceraMotion®



Veneering ceramics and accessories.

The ceraMotion® concept unites the highest demands on aesthetics with the most modern materials technology within a logical system. The resulting products are developed and produced in our own company. The result is a well-structured ceramic product line with veneer and press ceramics.

	ceraMotion®_{Zr} Veneering ceramic for zirconium oxide and lithium disilicate frameworks
	ceraMotion®_{Me} Veneering ceramic for metal frameworks (CTE 13.9–15.1)
	ceraMotion®_{Ti} Veneering ceramic for titanium and titanium alloys
	ceraMotion®_{Lf} Low-fusing veneering ceramic for alloys with a high CTE value

ceraMotion® Value Concept.

Along with shape and color, the brightness of a tooth plays an important role. Bearing this in mind, a crown can become the tooth.

ceraMotion® Chroma Concept.

Special dentin masses make it possible to extend the range of shades. There is almost no end to the spectrum of red, yellow and white shades.

ceraMotion® Touch Up.

The special ceramic masses ceraMotion® Touch Up complement the portfolio of the ceramic system. The lower firing temperature creates new application possibilities.



Veneering ceramics

ceramotion[®]_{Zr} – Zirconium oxide ceramic



8 Shade Set

Set for veneering zirconium oxide and lithium disilicate.
Contains the 8 most important A-D shades, Base Dentins,
Dentins, Incisal and effect materials.
Compatible with ceramotion[®] PZr press-on ceramic.

REF 250-800-25	1 set
-----------------------	-------

CE 0483

Contents:

Designation	REF	Quantity
Base Dentin BD A1	250-021-20	20 g
Base Dentin BD A2	250-022-20	20 g
Base Dentin BD A3	250-023-20	20 g
Base Dentin BD A3,5	250-024-20	20 g
Base Dentin BD B2	250-027-20	20 g
Base Dentin BD B3	250-028-20	20 g
Base Dentin BD C3	250-032-20	20 g
Base Dentin BD D3	250-035-20	20 g
Dentin D A1	250-041-20	20 g
Dentin D A2	250-042-20	20 g
Dentin D A3	250-043-20	20 g
Dentin D A3,5	250-044-20	20 g
Dentin D B2	250-047-20	20 g
Dentin D B3	250-048-20	20 g
Dentin D C3	250-052-20	20 g
Dentin D D3	250-055-20	20 g
Incisal I 1	250-060-20	20 g

Designation	REF	Quantity
Incisal I 2	250-061-20	20 g
Incisal Opal IO 1	250-065-20	20 g
Incisal Opal IO 2	250-066-20	20 g
Incisal Transpa IT 1	250-070-20	20 g
Incisal Transpa IT 2	250-071-20	20 g
Transpa T transpa	250-075-20	20 g
Correction C transpa	250-095-03	3 g
Dentin Modifier Chroma DM C orange	250-114-20	20 g
Dentin Modifier Fluo DM F yellow	250-116-20	20 g
Incisal Modifier IM opal honey	250-121-20	20 g
Incisal Modifier IM opal white	250-122-20	20 g
Incisal Modifier IM opal blue	250-123-20	20 g
Glaze GL transpa	250-270-02	2 g
Modelling Liquid	254-000-10	100 ml
Powder BOL Liquid	254-008-10	100 ml
Stains Liquid	254-010-02	20 ml
Shade Disc Incisal	254-100-00	1 piece



3 Shade Set

Set for veneering zirconium oxide and lithium disilicate.
Contains the 3 most important A-B shades, Base Dentins,
Dentins, Incisal and effect materials.
Compatible with ceraMotion® PZr press-on ceramic.

REF 250-900-25	1 set
----------------	-------

CE 0483

Contents:

Designation	REF	Quantity
Base Dentin BD A2	250-022-20	20 g
Base Dentin BD A3	250-023-20	20 g
Base Dentin BD B2	250-027-20	20 g
Dentin D A2	250-042-20	20 g
Dentin D A3	250-043-20	20 g
Dentin D B2	250-047-20	20 g
Incisal I 1	250-060-20	20 g
Incisal I 2	250-061-20	20 g

Designation	REF	Quantity
Incisal Transpa IT 1	250-070-20	20 g
Incisal Transpa IT 2	250-071-20	20 g
Transpa T transpa	250-075-20	20 g
Glaze GL transpa	250-270-02	2 g
Modelling Liquid	254-000-02	20 ml
Powder BOL Liquid	254-008-02	20 ml
Stains Liquid	254-010-02	20 ml



Veneering ceramics

ceraMotion®_{Zr} – Zirconium oxide ceramic



Value Concept Set

Set for veneering zirconium oxide and lithium disilicate.
Contains 13 modifiers for the cervical, dental and incisal areas.

No restrictions in compatibility with ceraMotion® Zr.

- Brightness can be determined without changing the color
- Special incisal masses for color stability, especially where space is limited

REF 250-800-60	1 set
----------------	-------

CE 0483

Contents:

Designation	REF	Quantity
Incisal Value IV 1	250-280-20	20 g
Incisal Value IV 2	250-281-20	20 g
Incisal Value IV 3	250-282-20	20 g
Value Modifier Bright Dentin opal VM B Dentin opal	250-287-20	20 g
Value Modifier Bright Incisal opal VM B Incisal opal	250-284-20	20 g
Incisal Modifier Value IM V opal pure	250-283-20	20 g
Incisal Modifier Value IM V opal pink	250-285-20	20 g

Designation	REF	Quantity
Incisal Modifier Value IM V opal violet	250-286-20	20 g
Incisal Modifier Value IM V opal grey	250-125-20	20 g
Transpa Value TV transpa	250-291-20	20 g
Transpa Modifier Value TM V orange	250-288-20	20 g
Transpa Modifier Value TM V lemon	250-289-20	20 g
Transpa Modifier Value TM V salmon	250-290-20	20 g
Shade Disc Value Concept	254-106-00	1 piece



Chroma Concept Set

Set for extending the color space of standard and bleach materials.

The set produces all the hues of the shade guide of other suppliers (e.g. Vita 3D-Master[®]* or Ivoclar-Chromascop[®]**).

Contains 17 ceramic materials including Dentins and bleach modules.

REF 250-800-55	1 set
-----------------------	-------

CE 0483

Contents:

Designation	REF	Quantity
Chroma Concept Dentin CC D 1, bleach	250-231-20	20 g
Chroma Concept Dentin CC D 2, bleach	250-232-20	20 g
Chroma Concept Dentin CC D 3	250-233-20	20 g
Chroma Concept Dentin CC D 4	250-234-20	20 g
Chroma Concept Dentin CC D 5	250-235-20	20 g
Chroma Concept Dentin CC D 6	250-236-20	20 g
Chroma Concept Dentin CC D 7	250-237-20	20 g

Designation	REF	Quantity
Chroma Concept Dentin CC D 8	250-238-20	20 g
Chroma Concept Dentin CC D 9	250-239-20	20 g
Chroma Concept Dentin CC D 10	250-240-20	20 g
Chroma Concept Dentin CC D 11	250-241-20	20 g
Chroma Concept Dentin CC D 12	250-242-20	20 g
Chroma Concept Incisal CC I 1, bleach	250-245-20	20 g
Shade Disc Chroma Concept / Bleach	254-102-00	1 piece

* Vita 3D-Master[®] is a registered trademark of Vita Zahnfabrik H. Rauter GmbH & Co.KG, 79704 Bad Säckingen, Germany.

** Ivoclar-Chromascop[®] is a registered trademark of Ivoclar Vivadent GmbH.

Veneering ceramics

ceraMotion[®] Zr – Zirconium oxide ceramic



Touch Up Set

Set for facilitating finishing or corrections due to lower firing temperatures.

Contains 9 ceramic materials including Base Dentins, Dentins and Incisal materials.

REF 250-800-50

1 set

CE 0483

Contents:

Designation	REF	Quantity
Touch Up Base Dentin TU BD light	250-251-20	20 g
Touch Up Base Dentin TU BD medium	250-252-20	20 g
Touch Up Base Dentin TU BD dark	250-253-20	20 g
Touch Up Dentin TU D light	250-255-20	20 g
Touch Up Dentin TU D medium	250-256-20	20 g

Designation	REF	Quantity
Touch Up Dentin TU D dark	250-257-20	20 g
Touch Up Incisal TU I medium	250-260-20	20 g
Touch Up Incisal TU I opal	250-261-20	20 g
Touch Up Incisal TU I transpa	250-262-20	20 g
Shade Disc Touch Up	254-103-00	1 piece



Stains Universal Set

Set containing 16 stains (3 opaque shades and 13 characterization shades) for internal and external effects.

REF 254-800-30	1 set
----------------	-------

CE 0483

Contents:

Designation	REF	Quantity
Body Stains B ST A	254-220-02	2 g
Body Stains B ST B	254-221-02	2 g
Body Stains B ST C	254-222-02	2 g
Stains ST white	254-201-02	2 g
Stains ST vanilla	254-202-02	2 g
Stains ST yellow	254-203-02	2 g
Stains ST orange	254-204-02	2 g
Stains ST pink	254-205-02	2 g
Stains ST purple	254-206-02	2 g

Designation	REF	Quantity
Stains ST blue	254-207-02	2 g
Stains ST grey	254-208-02	2 g
Stains ST olive green	254-209-02	2 g
Stains ST olive yellow	254-210-02	2 g
Stains ST medium brown	254-211-02	2 g
Stains ST red brown	254-212-02	2 g
Stains ST black	254-213-02	2 g
Stains Liquid	254-010-02	20 ml
Shade Disc Stains	254-105-00	1 piece



ceraMotion[®] Zr – Zirconium oxide ceramic



Liner L

For use on white ZrO₂ as color base.

- for shade optimization with colored ZrO₂
- produces natural fluorescence in the veneer

Liquid: Powder BOL Liquid

Shade code	REF (20 g)	REF (40 g)
L 1	250-001-20	250-001-40
L 2	250-002-20	250-002-40
L 3	250-003-20	250-003-40
L 4	250-004-20	250-004-40
L 5	250-005-20	250-005-40
L 6	250-006-20	250-006-40

CE⁰⁴⁸³

Mixing recommendations						
Tooth shade	L1	L2	L3	L4	L5	L6
A1	1/3				2/3	
A2	2/3				1/3	
A3	1					
A3,5	3/4					1/4
A4	1/2					1/2
B1		1/3			2/3	
B2		2/3			1/3	
B3		3/4			1/4	
B4		1				
C1			1/3		2/3	
C2			2/3		1/3	
C3			3/4		1/4	
C4			1			
D2				2/3	1/3	
D3				3/4	1/4	
D4		1/3		2/3		



Liner Modifier LM

- customized accentuation of the Liner

Liquid: Powder BOL Liquid

Shade code	REF	Quantity
LM gingival	250-018-20	20 g
LM orange	250-019-20	20 g

CE⁰⁴⁸³

Base Dentin BD

- has a higher opacity than Dentin
- diffusing effect
- three-dimensional depth effect (after finishing)
- support of the actual tooth shade (even if there is unfavorable space availability)
- increases reflection from deep in the ceramic

Liquid: Modelling Liquid, Modelling Liquid +



Shade code	REF (20 g)	REF (40 g)
BD A1	250-021-20	250-021-40
BD A2	250-022-20	250-022-40
BD A3	250-023-20	250-023-40
BD A3,5	250-024-20	250-024-40
BD A4	250-025-20	250-025-40
BD B1	250-026-20	250-026-40
BD B2	250-027-20	250-027-40
BD B3	250-028-20	250-028-40
BD B4	250-029-20	250-029-40
BD C1	250-030-20	250-030-40
BD C2	250-031-20	250-031-40
BD C3	250-032-20	250-032-40
BD C4	250-033-20	250-033-40
BD D2	250-034-20	250-034-40
BD D3	250-035-20	250-035-40
BD D4	250-036-20	250-036-40

CE 0483

Base Dentin Modifier BDM

Effect material with increased opacity

- produces depth of shade
- controls the brightness value
- reproduction of natural effects in the dental, proximal and mamelon regions

Liquid: Modelling Liquid, Modelling Liquid +



Color	REF	Quantity
salmon	250-101-20	20 g
caramel	250-102-20	20 g
ochre	250-103-20	20 g
ivory	250-104-20	20 g
lemon	250-105-20	20 g
vanilla	250-106-20	20 g
brown	250-107-20	20 g

CE 0483

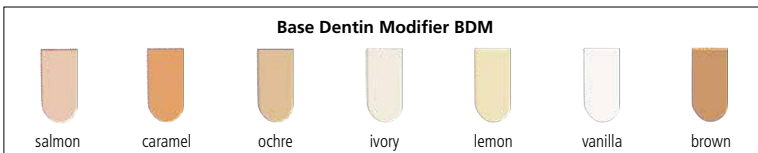

ceraMotion[®] Zr – Zirconium oxide ceramic



Dentin D

Standard Dentin

- produces the primary shade effect
- natural fluorescence
- prism effects

Liquid: Modelling Liquid, Modelling Liquid +

Shade code	REF (20 g)	REF (40 g)
D A1	250-041-20	250-041-40
D A2	250-042-20	250-042-40
D A3	250-043-20	250-043-40
D A3,5	250-044-20	250-044-40
D A4	250-045-20	250-045-40
D B1	250-046-20	250-046-40
D B2	250-047-20	250-047-40
D B3	250-048-20	250-048-40
D B4	250-049-20	250-049-40
D C1	250-050-20	250-050-40
D C2	250-051-20	250-051-40
D C3	250-052-20	250-052-40
D C4	250-053-20	250-053-40
D D2	250-054-20	250-054-40
D D3	250-055-20	250-055-40
D D4	250-056-20	250-056-40

CE⁰⁴⁸³

Incisal allocation table			
Dentin shade	Incisal Standard	Incisal Opal	Incisal Transpa
A1, A2, B1	I 1	IO 1	IT 1
A3, A3,5, B2, B3, B4, C1, C2, C3, D2, D3, D4	I 2	IO 2	IT 2
A4, C4	I 3	IO 3	IT 3

Dentin Modifier Chroma DM C

- controls the intensity of the respective hue
 - increases the depth of shade, even with a reduced layer thickness
- Liquid: Modelling Liquid, Modelling Liquid +

Shade code	REF	Quantity
DM C A	250-111-20	20 g
DM C B	250-112-20	20 g
DM C C	250-113-20	20 g
DM C orange	250-114-20	20 g

CE 0483



Dentin Modifier Fluo DM F

Dentin effect material with increased fluorescence

- controls the brightness value
- Liquid: Modelling Liquid, Modelling Liquid +

Shade code	REF	Quantity
DM F cream	250-115-20	20 g
DM F yellow	250-116-20	20 g
DM F orange	250-117-20	20 g

CE 0483

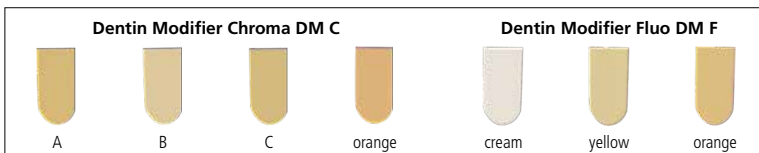

Veneering ceramics

ceraMotion[®]_{Zr} – Zirconium oxide ceramic



Incisal I

Standard incisal material

- application in the incisal region

Liquid: Modelling Liquid, Modelling Liquid +

Shade code	REF (20 g)	REF (40 g)
I 1	250-060-20	250-060-40
I 2	250-061-20	250-061-40
I 3	250-062-20	250-062-40

CE 0483



Incisal Opal IO

- for alternate layering incisally
- opalescent: bluish effect in reflected light
- orange-colored effect in light transmitted through the ceramic
- enhances the natural light refraction
- application in the incisal region

Liquid: Modelling Liquid, Modelling Liquid +

Shade code	REF (20 g)	REF (40 g)
IO 1	250-065-20	250-065-40
IO 2	250-066-20	250-066-40
IO 3	250-067-20	250-067-40

CE 0483



Incisal Transpa IT

- increased transparency in the materials
- application in the incisal region

Liquid: Modelling Liquid, Modelling Liquid +

Shade code	REF (20 g)	REF (40 g)
IT 1	250-070-20	250-070-40
IT 2	250-071-20	250-071-40
IT 3	250-072-20	250-072-40

CE 0483

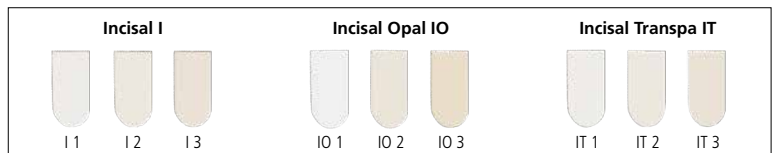

Transpa T

- highly transparent material
 - application in the incisal region, as required
- Liquid: Modelling Liquid, Modelling Liquid +

Shade code	REF (20 g)	REF (40 g)
T transpa	250-075-20	250-075-40

CE 0483



Incisal Modifier IM

- enhances the natural light refraction
- for alternate layering incisally
- application in the incisal region

Liquid: Modelling Liquid, Modelling Liquid +

Shade code	REF	Quantity
IM opal honey	250-121-20	20 g
IM opal white	250-122-20	20 g
IM opal blue	250-123-20	20 g
IM grey	250-124-20	20 g
IM opal grey	250-125-20	20 g

CE 0483

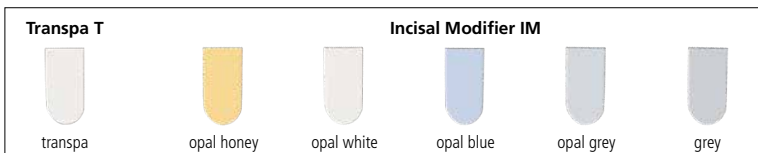

Veneering ceramics

ceramotion[®]_{Zr} – Zirconium oxide ceramic



Shoulder SM

Shoulder material

With the shoulder material "white" it is possible to individually mix all shade nuances from A1 to D4 by following the information in the mixing table.

By adding the shoulder material "transparent", the translucence is increased in the shoulder.

Liquid: Shoulder Liquid

Shade code	REF	Quantity
SM A	250-081-20	20 g
SM B	250-082-20	20 g
SM C	250-083-20	20 g
SM D	250-084-20	20 g
SM white	250-085-20	20 g
SM transpa	250-086-20	20 g

CE⁰⁴⁸³



Gingival G

- build-up and reconstruction of gingiva and papillae
- compensation of mucosal defects

Liquid: Modelling Liquid, Modelling Liquid +

Shade code	REF	Quantity
G 1	250-090-20	20 g
G 2	250-091-20	20 g
G 3	250-092-20	20 g
G 4	250-093-20	20 g

CE⁰⁴⁸³



Incisal Value IV

Modifiers with higher opacity.

- opaque incisal modifiers where space is limited

Liquid: Modelling Liquid

Shade code	REF	Quantity
IV 1	250-280-20	20 g
IV 2	250-281-20	20 g
IV 3	250-282-20	20 g

CE⁰⁴⁸³



Value Modifier Bright Incisal opal VM B

- to determine / increase brightness in the incisal area

Liquid: Modelling Liquid

Shade code	REF	Quantity
VM B Incisal opal	250-284-20	20 g

CE⁰⁴⁸³

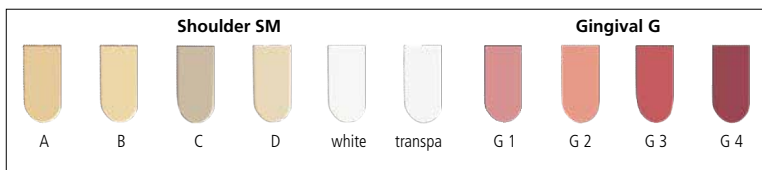

Value Modifier Bright Dentin opal VM B

- to determine the brightness of the dentine body without changing the color

Liquid: Modelling Liquid

Shade code	REF	Quantity
VM B Dentin opal	250-287-20	20 g

CE 0483



Incisal Modifier Value IM V

- colored opalescent shade modifier to optimize the in-depth effect
- to determine the intensity of incisal regions

Liquid: Modelling Liquid

Shade code	REF	Quantity
IM V opal pure*	250-283-20	20 g
IM V opal pink	250-285-20	20 g
IM V opal violet	250-286-20	20 g

CE 0483

* pure opalescent modifier



Transpa Modifier Value TM V

- natural light optical effects in the cervical and incisal area

Liquid: Modelling Liquid

Shade code	REF	Quantity
TM V orange	250-288-20	20 g
TM V lemon	250-289-20	20 g
TM V salmon	250-290-20	20 g

CE 0483



Transpa Value TV

- transparent modifier, slightly opaque

Liquid: Modelling Liquid

Shade code	REF	Quantity
TV transpa	250-291-20	20 g

CE 0483

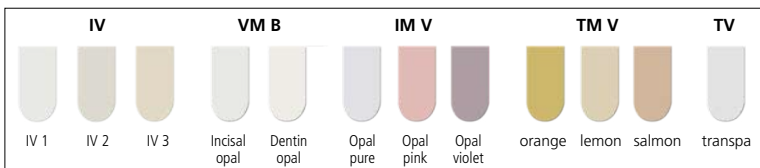

Veneering ceramics

ceramotion[®]_{Zr} – Zirconium oxide ceramic



Chroma Concept Liner CC L

- increases the reflection from deep in the ceramic
- Liquid: Powder BOL Liquid

Shade code	REF	Quantity
CC L 1, bleach	250-221-20	20 g
CC L 2	250-222-20	20 g
CC L 3	250-223-20	20 g
CC L 4	250-224-20	20 g

CE⁰⁴⁸³



Chroma Concept Dentin CC D

- pure or mixed, for extending the color space
 - same opaque characteristics as dentin
 - white and light dentin bleaching materials
 - produces all the hues of the shade guide of other suppliers (e.g. Vita 3D-Master[®]* or Ivoclar-Chromascop[®]**)
- Liquid: Modelling Liquid, Modelling Liquid +

Shade code	REF	Quantity
CC D 1, bleach	250-231-20	20 g
CC D 2, bleach	250-232-20	20 g
CC D 3	250-233-20	20 g
CC D 4	250-234-20	20 g
CC D 5	250-235-20	20 g
CC D 6	250-236-20	20 g
CC D 7	250-237-20	20 g
CC D 8	250-238-20	20 g
CC D 9	250-239-20	20 g
CC D 10	250-240-20	20 g
CC D 11	250-241-20	20 g
CC D 12	250-242-20	20 g

CE⁰⁴⁸³

* Vita 3D-Master[®] is a registered trademark of Vita Zahnfabrik H. Rauter GmbH & Co.KG, 79704 Bad Säckingen, Germany.
** Ivoclar-Chromascop[®] is a registered trademark of Ivoclar Vivadent GmbH.



Chroma Concept Incisal CC I

- Light incisal bleaching material
- Liquid: Modelling Liquid, Modelling Liquid +

Shade code	REF	Quantity
CC I 1, bleach	250-245-20	20 g

CE⁰⁴⁸³

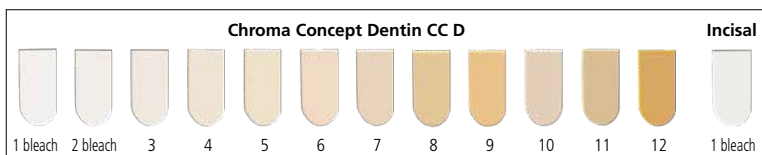

Touch Up Base Dentin TU BD

Low-fusing material for correction and glaze firing in one.

- greater reliability due to highly condensed fitting surfaces

Liquid: Modelling Liquid, Modelling Liquid +

Shade code	REF	Quantity
TU BD light	250-251-20	20 g
TU BD medium	250-252-20	20 g
TU BD dark	250-253-20	20 g

CE 0483



Touch Up Dentin TU D

Low-fusing material for correction and glaze firing in one.

- highly condensed marginal ridges enhance the aesthetics

Liquid: Modelling Liquid, Modelling Liquid +

Shade code	REF	Quantity
TU D light	250-255-20	20 g
TU D medium	250-256-20	20 g
TU D dark	250-257-20	20 g

CE 0483



Touch Up Incisal TU I

Low-fusing material for correction and glaze firing in one.

- highly condensed marginal ridges enhance the aesthetics

Liquid: Modelling Liquid, Modelling Liquid +

Shade code	REF	Quantity
TU I medium	250-260-20	20 g
TU I opal	250-261-20	20 g
TU I transpa	250-262-20	20 g

CE 0483



Touch Up Gingival TU G

- for corrections or additions in the gingival area

Liquid: Modelling Liquid

Shade code	REF	Quantity
TU G2	250-263-20	20 g
TU G4	250-264-20	20 g

CE 0483

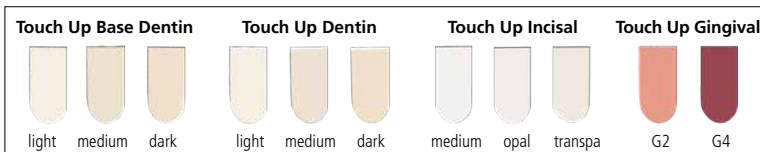

Veneering ceramics

ceramotion[®]_{Zr} – Zirconium oxide ceramic



Correction C

Low-fusing material, used for minor corrections.

Firing temperature: 715 °C / 1319 °F

Liquid: Modelling Liquid, Modelling Liquid +

Shade code	REF	Quantity
C transpa	250-095-03	3 g

CE 0483



Glaze GL

Glaze material, pure or for mixing with Stains and Body Stains.

Liquid: Stains Liquid

Shade code	REF	Quantity
GL transpa	250-270-02	2 g

CE 0483



Paste Glaze PGL

Glaze material in paste form.

Particularly suitable for monolithic restorations made of zirconium oxide and lithium disilicate.

- fluorescent
- can be applied precisely

Shade code	REF	Quantity
PGL transpa	250-271-03	3 g

CE 0483

Body Stains B ST

Stains for internal and external application

- for mixing with the glaze material
- individual color accentuation
- produces a particularly deep shade
- can be mixed up to 10 % in ceramic materials

Liquid: Stains Liquid



Shade code	REF	Quantity
B ST A	254-220-02	2 g
B ST B	254-221-02	2 g
B ST C	254-222-02	2 g



CE 0483

Stains ST

Stains for internal and external application

- for mixing with the glaze material
- individual color accentuation
- produces a particularly deep shade
- can be mixed up to 10 % in ceramic materials

Liquid: Stains Liquid



Shade code	REF	Quantity
ST 1 white	254-201-02	2 g
ST 2 vanilla	254-202-02	2 g
ST 3 yellow	254-203-02	2 g
ST 4 orange	254-204-02	2 g
ST 5 pink	254-205-02	2 g
ST 6 purple	254-206-02	2 g
ST 7 blue	254-207-02	2 g
ST 8 grey	254-208-02	2 g
ST 9 olive green	254-209-02	2 g
ST 10 olive yellow	254-210-02	2 g
ST 11 medium brown	254-211-02	2 g
ST 12 red brown	254-212-02	2 g
ST 13 black	254-213-02	2 g



CE 0483

Veneering ceramics

ceraMotion[®]_{Zr} – Zirconium oxide ceramic



Modelling Liquid

Standard liquid for mixing the ceramic materials.

REF 254-000-02	20 ml
REF 254-000-10	100 ml
REF 254-000-50	500 ml



Modelling Liquid +

Modelling liquid with slightly increased viscosity.

REF 254-002-02	20 ml
REF 254-002-10	100 ml
REF 254-002-50	500 ml



Powder BOL Liquid

For mixing the powder bonder, opaque powder, powder liner.

REF 254-008-02	20 ml
REF 254-008-10	100 ml



Shoulder Liquid

For mixing the shoulder materials.

- increases the positional stability

REF 254-004-02	20 ml
REF 254-004-10	100 ml



Stains Liquid

For mixing the stains and the glaze/glaze material.

REF 254-010-02	20 ml
REF 254-010-10	100 ml



Modelling Liquid MV universal

- to increase plasticity
- to extend modeling properties

REF 299-150-40	20 ml
REF 299-150-80	100 ml

Contrast Marker

For coloring mixed ceramic materials.

- for a better contrast when building up
- burns out without residue
- the same viscosity as the modelling liquid



Color	REF	Quantity
vanilla	254-300-02	20 ml
orange	254-301-02	20 ml
red	254-302-02	20 ml
blue	254-303-02	20 ml
green	254-304-02	20 ml



Veneering ceramics

ceramotion[®] Me – Metal ceramic



8 Shade Set (Paste Opaque)

Set for veneering alloys in the conventional CTE range of 13.9 to 15.1 · 10⁻⁶ K⁻¹ at 25–500 °C / 77–932 °F.

Contains the 8 most important A–D shades, Paste Opaque, Base Dentins, Dentins, Incisal and effect materials.

Compatible with ceramotion[®] PMe press-on ceramic.

REF 252-800-10	1 set
----------------	-------

CE 0483

Contents:

Designation	REF	Quantity
Paste Opaque PO A1	252-501-03	3 g
Paste Opaque PO A2	252-502-03	3 g
Paste Opaque PO A3	252-503-03	3 g
Paste Opaque PO A3,5	252-504-03	3 g
Paste Opaque PO B2	252-507-03	3 g
Paste Opaque PO B3	252-508-03	3 g
Paste Opaque PO C3	252-512-03	3 g
Paste Opaque PO D3	252-515-03	3 g
Base Dentin BD A1	252-021-20	20 g
Base Dentin BD A2	252-022-20	20 g
Base Dentin BD A3	252-023-20	20 g
Base Dentin BD A3,5	252-024-20	20 g
Base Dentin BD B2	252-027-20	20 g
Base Dentin BD B3	252-028-20	20 g
Base Dentin BD C3	252-032-20	20 g
Base Dentin BD D3	252-035-20	20 g
Dentin D A1	252-041-20	20 g
Dentin D A2	252-042-20	20 g
Dentin D A3	252-043-20	20 g
Dentin D A3,5	252-044-20	20 g
Dentin D B2	252-047-20	20 g

Designation	REF	Quantity
Dentin D B3	252-048-20	20 g
Dentin D C3	252-052-20	20 g
Dentin D D3	252-055-20	20 g
Incisal I 1	252-060-20	20 g
Incisal I 2	252-061-20	20 g
Incisal Opal IO 1	252-065-20	20 g
Incisal Opal IO 2	252-066-20	20 g
Incisal Transpa IT 1	252-070-20	20 g
Incisal Transpa IT 2	252-071-20	20 g
Transpa T transpa	252-075-20	20 g
Dentin Modifier Chroma DM C orange	252-114-20	20 g
Dentin Modifier Fluo DM F yellow	252-116-20	20 g
Incisal Modifier IM opal honey	252-121-20	20 g
Incisal Modifier IM opal white	252-122-20	20 g
Incisal Modifier IM opal blue	252-123-20	20 g
Glaze GL transpa	252-270-02	2 g
Correction C transpa	252-095-03	3 g
Me Standard Modelling Liquid	254-001-10	100 ml
Paste Liquid	254-006-02	20 ml
Stains Liquid	254-010-02	20 ml
Shade Disc Incisal	254-100-00	1 piece



3 Shade Set (Paste Opaque)

Set for veneering alloys in the conventional CTE range of 13.9 to 15.1 · 10⁻⁶ K⁻¹ at 25–500 °C / 77–932 °F.

Contains the 3 most important A–B shades, Paste Opaque, Base Dentins, Dentins, Incisal and effect materials.

Compatible with ceraMotion[®] PMe press-on ceramic.

REF 252-900-15	1 set
----------------	-------

CE 0483

Contents:

Designation	REF	Quantity
Base Dentin BD A2	252-022-20	20 g
Base Dentin BD A3	252-023-20	20 g
Base Dentin BD B2	252-027-20	20 g
Dentin D A2	252-042-20	20 g
Dentin D A3	252-043-20	20 g
Dentin D B2	252-047-20	20 g
Incisal I 1	252-060-20	20 g
Incisal I 2	252-061-20	20 g
Incisal Transpa IT 1	252-070-20	20 g

Designation	REF	Quantity
Incisal Transpa IT 2	252-071-20	20 g
Transpa T transpa	252-075-20	20 g
Glaze GL transpa	252-270-02	2 g
Paste Opaque PO A2	252-502-03	3 g
Paste Opaque PO A3	252-503-03	3 g
Paste Opaque PO B2	252-507-03	3 g
Me Standard Modelling Liquid	254-001-02	20 ml
Paste Liquid	254-006-02	20 ml
Stains Liquid	254-010-02	20 ml



Veneering ceramics

ceramotion[®]_{Me} – Metal ceramic



8 Shade Set (Powder Opaque)

Set for veneering alloys in the conventional CTE range of 13.9 to 15.1 · 10⁻⁶ K⁻¹ at 25–500 °C / 77–932 °F.

Contains the 8 most important A–D shades, opaque powders, Base Dentins, Dentins, Incisal and effect materials.

Compatible with ceramotion[®] PMe press-on ceramic.

REF 252-800-15	1 set
----------------	-------

CE 0483

Contents:

Designation	REF	Quantity
Opaque O A1	252-001-20	20 g
Opaque O A2	252-002-20	20 g
Opaque O A3	252-003-20	20 g
Opaque O A3,5	252-004-20	20 g
Opaque O B2	252-007-20	20 g
Opaque O B3	252-008-20	20 g
Opaque O C3	252-012-20	20 g
Opaque O D3	252-015-20	20 g
Base Dentin BD A1	252-021-20	20 g
Base Dentin BD A2	252-022-20	20 g
Base Dentin BD A3	252-023-20	20 g
Base Dentin BD A3,5	252-024-20	20 g
Base Dentin BD B2	252-027-20	20 g
Base Dentin BD B3	252-028-20	20 g
Base Dentin BD C3	252-032-20	20 g
Base Dentin BD D3	252-035-20	20 g
Dentin D A1	252-041-20	20 g
Dentin D A2	252-042-20	20 g
Dentin D A3	252-043-20	20 g
Dentin D A3,5	252-044-20	20 g
Dentin D B2	252-047-20	20 g

Designation	REF	Quantity
Dentin D B3	252-048-20	20 g
Dentin D C3	252-052-20	20 g
Dentin D D3	252-055-20	20 g
Incisal I 1	252-060-20	20 g
Incisal I 2	252-061-20	20 g
Incisal Opal IO 1	252-065-20	20 g
Incisal Opal IO 2	252-066-20	20 g
Incisal Transpa IT 1	252-070-20	20 g
Incisal Transpa IT 2	252-071-20	20 g
Transpa T transpa	252-075-20	20 g
Dentin Modifier Chroma DM C orange	252-114-20	20 g
Dentin Modifier Fluo DM F yellow	252-116-20	20 g
Incisal Modifier IM opal honey	252-121-20	20 g
Incisal Modifier IM opal white	252-122-20	20 g
Incisal Modifier IM opal blue	252-123-20	20 g
Glaze GL transpa	252-270-02	2 g
Correction C transpa	252-095-03	3 g
Me Standard Modelling Liquid	254-001-10	100 ml
Powder BOL Liquid	254-008-10	100 ml
Stains Liquid	254-010-02	20 ml
Shade Disc Incisal	254-100-00	1 piece



Value Concept Set

Set for veneering alloys in the conventional CTE range of 13.9 to 15.1 · 10⁻⁶ K⁻¹ at 25–500 °C / 77-932 °F.

Contains 13 new modifiers for the cervical, dentinal and incisal areas.

No restrictions in compatibility with ceraMotion[®] Me.

- brightness can be determined without changing the color
- special incisal masses for color stability, especially where space is limited

REF 252-800-60	1 set
-----------------------	-------

CE 0483

Contents:

Designation	REF	Quantity
Incisal Value IV 1	252-280-20	20 g
Incisal Value IV 2	252-281-20	20 g
Incisal Value IV 3	252-282-20	20 g
Value Modifier Bright Dentin opal VM B Dentin opal	252-287-20	20 g
Value Modifier Bright Incisal opal VM B Incisal opal	252-284-20	20 g
Incisal Modifier Value IM V opal pure	252-283-20	20 g
Incisal Modifier Value IM V opal pink	252-285-20	20 g

Designation	REF	Quantity
Incisal Modifier Value IM V opal violet	252-286-20	20 g
Incisal Modifier IM opal grey	252-125-20	20 g
Transpa Value TV transpa	252-291-20	20 g
Transpa Modifier Value TM V orange	252-288-20	20 g
Transpa Modifier Value TM V lemon	252-289-20	20 g
Transpa Modifier Value TM V salmon	252-290-20	20 g
Shade Disc Value Concept	254-106-00	1 piece

Veneering ceramics

ceraMotion[®]_{Me} – Metal ceramic



Chroma Concept Set

Set for extending the color space of standard and bleach materials.

The set produces all the hues of the shade guide of other suppliers (e.g. Vita 3D-Master[®]* or Ivoclar-Chromascop[®]**).

Contains 17 ceramic materials including Paste Opaque, Dentins and bleach modules.

REF 252-800-45

1 set

CE 0483

Contents:

Designation	REF	Quantity
Chroma Concept Paste Opaque CC PO 1, bleach	252-541-03	3 g
Chroma Concept Paste Opaque CC PO 2	252-542-03	3 g
Chroma Concept Paste Opaque CC PO 3	252-543-03	3 g
Chroma Concept Paste Opaque CC PO 4	252-544-03	3 g
Chroma Concept Dentin CC D 1, bleach	252-231-20	20 g
Chroma Concept Dentin CC D 2, bleach	252-232-20	20 g
Chroma Concept Dentin CC D 3	252-233-20	20 g
Chroma Concept Dentin CC D 4	252-234-20	20 g
Chroma Concept Dentin CC D 5	252-235-20	20 g

Designation	REF	Quantity
Chroma Concept Dentin CC D 6	252-236-20	20 g
Chroma Concept Dentin CC D 7	252-237-20	20 g
Chroma Concept Dentin CC D 8	252-238-20	20 g
Chroma Concept Dentin CC D 9	252-239-20	20 g
Chroma Concept Dentin CC D 10	252-240-20	20 g
Chroma Concept Dentin CC D 11	252-241-20	20 g
Chroma Concept Dentin CC D 12	252-242-20	20 g
Chroma Concept Incisal CC I 1, bleach	252-245-20	20 g
Shade Disc Chroma Concept / Bleach	254-102-00	1 piece

* Vita 3D-Master[®] is a registered trademark of Vita Zahnfabrik H. Rauter GmbH & Co.KG, 79704 Bad Säckingen, Germany.

** Ivoclar-Chromascop[®] is a registered trademark of Ivoclar Vivadent GmbH.

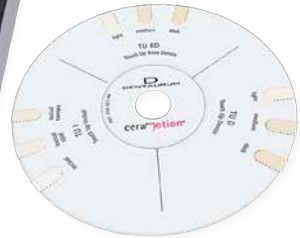

Touch Up Set

Set for facilitating finishing or corrections due to lower firing temperatures.

Contains 10 ceramic materials including Paste Opaque, Base Dentins, Dentins and Incisal materials.

REF 252-800-50

1 set

CE 0483

Contents:

Designation	REF	Quantity
Touch Up Paste Opaque TU PO medium	252-250-03	3 g
Touch Up Base Dentin TU BD light	252-251-20	20 g
Touch Up Base Dentin TU BD medium	252-252-20	20 g
Touch Up Base Dentin TU BD dark	252-253-20	20 g
Touch Up Dentin TU D light	252-255-20	20 g
Touch Up Dentin TU D medium	252-256-20	20 g

Designation	REF	Quantity
Touch Up Dentin TU D dark	252-257-20	20 g
Touch Up Incisal TU I medium	252-260-20	20 g
Touch Up Incisal TU I opal	252-261-20	20 g
Touch Up Incisal TU I transpa	252-262-20	20 g
Shade Disc Touch Up	254-103-00	1 piece





Stains Universal Set

Set containing 16 stains (3 opaque shades and 13 characterization shades) for internal and external effects.

REF 254-800-30	1 set
----------------	-------

CE 0483

Contents:

Designation	REF	Quantity
Body Stains B ST A	254-220-02	2 g
Body Stains B ST B	254-221-02	2 g
Body Stains B ST C	254-222-02	2 g
Stains ST white	254-201-02	2 g
Stains ST vanilla	254-202-02	2 g
Stains ST yellow	254-203-02	2 g
Stains ST orange	254-204-02	2 g
Stains ST pink	254-205-02	2 g
Stains ST purple	254-206-02	2 g

Designation	REF	Quantity
Stains ST blue	254-207-02	2 g
Stains ST grey	254-208-02	2 g
Stains ST olive green	254-209-02	2 g
Stains ST olive yellow	254-210-02	2 g
Stains ST medium brown	254-211-02	2 g
Stains ST red brown	254-212-02	2 g
Stains ST black	254-213-02	2 g
Stains Liquid	254-010-02	20 ml
Shade Disc Stains	254-105-00	1 piece

Paste Opaque PO

Opaque paste

- can be universally used with all non-precious and precious metal alloys in the conventional CTE range, as well as for galvano gold and press-on technique
- maximum bonding strength due to TRC bonding (Tension Reduced Connection)
- good, dense coverage of the metal substructure
- easy, uncomplicated application

Liquid: Paste Liquid



Shade code	REF	Quantity
PO A1	252-501-03	3 g
PO A2	252-502-03	3 g
PO A3	252-503-03	3 g
PO A3,5	252-504-03	3 g
PO A4	252-505-03	3 g
PO B1	252-506-03	3 g
PO B2	252-507-03	3 g
PO B3	252-508-03	3 g
PO B4	252-509-03	3 g
PO C1	252-510-03	3 g
PO C2	252-511-03	3 g
PO C3	252-512-03	3 g
PO C4	252-513-03	3 g
PO D2	252-514-03	3 g
PO D3	252-515-03	3 g
PO D4	252-516-03	3 g

CE 0483

Paste Opaque Modifier POM

- customized accentuation of the opaque paste

Liquid: Paste Liquid

Shade code	REF	Quantity
POM gingival	252-520-03	3 g
POM orange	252-521-03	3 g

CE 0483



ceramotion[®] Me – Metal ceramic



Opaque O

Opaque powder

- minimal layer thickness
- good and dense coverage of the metal substructure
- especially suitable for use with silver-content alloys

Liquid: Powder BOL Liquid

Shade code	REF (20 g)	REF (40 g)
O A1	252-001-20	252-001-40
O A2	252-002-20	252-002-40
O A3	252-003-20	252-003-40
O A3,5	252-004-20	252-004-40
O A4	252-005-20	252-005-40
O B1	252-006-20	252-006-40
O B2	252-007-20	252-007-40
O B3	252-008-20	252-008-40
O B4	252-009-20	252-009-40
O C1	252-010-20	252-010-40
O C2	252-011-20	252-011-40
O C3	252-012-20	252-012-40
O C4	252-013-20	252-013-40
O D2	252-014-20	252-014-40
O D3	252-015-20	252-015-40
O D4	252-016-20	252-016-40

CE⁰⁴⁸³



Opaque Modifier OM

- customized accentuation of the opaque powder

Liquid: Powder BOL Liquid

Shade code	REF	Quantity
OM gingival	252-018-20	20 g
OM orange	252-019-20	20 g

CE⁰⁴⁸³

Base Dentin BD

- has a higher opacity than Dentin
- diffusing effect
- three-dimensional depth effect (after finishing)
- support of the actual tooth shade (even if there is unfavorable space availability)
- increases reflection from deep in the ceramic

Liquid: Me Standard Modelling Liquid, Modelling Liquid, Modelling Liquid +

Shade code	REF (20 g)	REF (40 g)
BD A1	252-021-20	252-021-40
BD A2	252-022-20	252-022-40
BD A3	252-023-20	252-023-40
BD A3,5	252-024-20	252-024-40
BD A4	252-025-20	252-025-40
BD B1	252-026-20	252-026-40
BD B2	252-027-20	252-027-40
BD B3	252-028-20	252-028-40
BD B4	252-029-20	252-029-40
BD C1	252-030-20	252-030-40
BD C2	252-031-20	252-031-40
BD C3	252-032-20	252-032-40
BD C4	252-033-20	252-033-40
BD D2	252-034-20	252-034-40
BD D3	252-035-20	252-035-40
BD D4	252-036-20	252-036-40



CE 0483

Base Dentin Modifier BDM

Effect material with increased opacity

- produces depth of shade
- controls the brightness value
- reproduction of natural effects in the dentin, proximal and mamelon regions

Liquid: Me Standard Modelling Liquid, Modelling Liquid, Modelling Liquid +

Shade code	REF	Quantity
BDM salmon	252-101-20	20 g
BDM caramel	252-102-20	20 g
BDM ochre	252-103-20	20 g
BDM ivory	252-104-20	20 g
BDM lemon	252-105-20	20 g
BDM vanilla	252-106-20	20 g
BDM brown	252-107-20	20 g



CE 0483

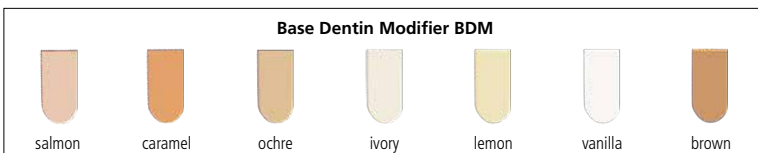

ceramotion[®] Me – Metal ceramic



Dentin D

Standard dentin

- produces the primary shade effect
- natural fluorescence
- prism effects

Liquid: Me Standard Modelling Liquid, Modelling Liquid, Modelling Liquid +

Shade code	REF (20 g)	REF (40 g)
D A1	252-041-20	252-041-40
D A2	252-042-20	252-042-40
D A3	252-043-20	252-043-40
D A3,5	252-044-20	252-044-40
D A4	252-045-20	252-045-40
D B1	252-046-20	252-046-40
D B2	252-047-20	252-047-40
D B3	252-048-20	252-048-40
D B4	252-049-20	252-049-40
D C1	252-050-20	252-050-40
D C2	252-051-20	252-051-40
D C3	252-052-20	252-052-40
D C4	252-053-20	252-053-40
D D2	252-054-20	252-054-40
D D3	252-055-20	252-055-40
D D4	252-056-20	252-056-40

CE⁰⁴⁸³

Incisal allocation table			
Dentin shade	Incisal Standard	Incisal Opal	Incisal Transpa
A1, A2, B1	I 1	IO 1	IT 1
A3, A3,5, B2, B3, B4, C1, C2, C3, D2, D3, D4	I 2	IO 2	IT 2
A4, C4	I 3	IO 3	IT 3

Dentin Modifier Chroma DM C

- controls the intensity of the respective hue
- increases the depth of shade, even with a reduced layer thickness

Liquid: Me Standard Modelling Liquid, Modelling Liquid, Modelling Liquid +

Shade code	REF	Quantity
DM C A	252-111-20	20 g
DM C B	252-112-20	20 g
DM C C	252-113-20	20 g
DM C orange	252-114-20	20 g

CE 0483



Dentin Modifier Fluo DM F

Dentin effect material with increased fluorescence

- controls the brightness value

Liquid: Me Standard Modelling Liquid, Modelling Liquid, Modelling Liquid +

Shade code	REF	Quantity
DM F cream	252-115-20	20 g
DM F yellow	252-116-20	20 g
DM F orange	252-117-20	20 g

CE 0483

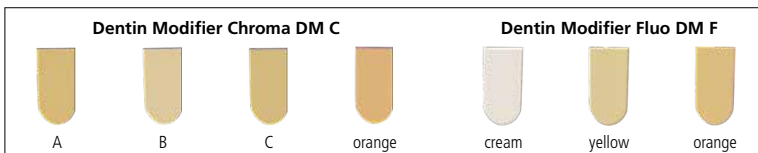

ceramotion[®] Me – Metal ceramic



Incisal I

Standard incisal material

- application in the incisal region

Liquid: Me Standard Modelling Liquid, Modelling Liquid, Modelling Liquid +

Shade code	REF (20 g)	REF (40 g)
I 1	252-060-20	252-060-40
I 2	252-061-20	252-061-40
I 3	252-062-20	252-062-40

CE 0483



Incisal Opal IO

- for alternate layering incisally
- opalescent: bluish effect in reflected light
- orange-colored effect in light transmitted through the ceramic
- enhances the natural light refraction
- application in the incisal region

Liquid: Me Standard Modelling Liquid, Modelling Liquid, Modelling Liquid +

Shade code	REF (20 g)	REF (40 g)
IO 1	252-065-20	252-065-40
IO 2	252-066-20	252-066-40
IO 3	252-067-20	252-067-40

CE 0483



Incisal Transpa IT

- increased transparency in the materials
- application in the incisal region

Liquid: Me Standard Modelling Liquid, Modelling Liquid, Modelling Liquid +

Shade code	REF (20 g)	REF (40 g)
IT 1	252-070-20	252-070-40
IT 2	252-071-20	252-071-40
IT 3	252-072-20	252-072-40

CE 0483

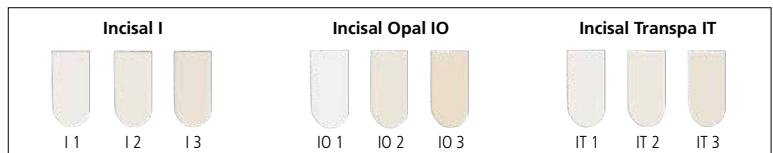

Transpa T

- transparent material
- application in the incisal region, as required

Liquid: Me Standard Modelling Liquid, Modelling Liquid, Modelling Liquid +

Shade code	REF (20 g)	REF (40 g)
T transpa	252-075-20	252-075-40

CE 0483



Incisal Modifier IM

- enhances the natural light refraction
- for alternate layering incisally
- application in the incisal region

Liquid: Me Standard Modelling Liquid, Modelling Liquid, Modelling Liquid +

Shade code	REF	Quantity
IM opal honey	252-121-20	20 g
IM opal white	252-122-20	20 g
IM opal blue	252-123-20	20 g
IM grey	252-124-20	20 g
IM opal grey	252-125-20	20 g

CE 0483

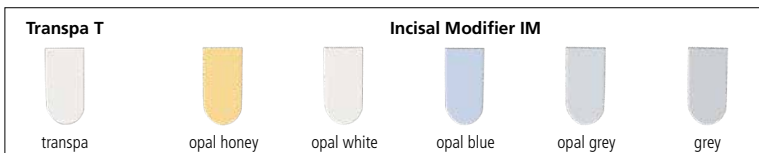

Veneering ceramics

ceraMotion^{Me} – Metal ceramic



Shoulder SM

Shoulder material

With the shoulder material "white" it is possible to individually mix all shade nuances from A1 to D4 by following the information in the mixing table.

By adding the shoulder material "transparent", the translucence is increased in the shoulder.

Liquid: Shoulder Liquid

Shade code	REF	Quantity
SM A	252-081-20	20 g
SM B	252-082-20	20 g
SM C	252-083-20	20 g
SM D	252-084-20	20 g
SM white	252-085-20	20 g
SM transpa	252-086-20	20 g

CE⁰⁴⁸³



Gingival G

- build-up and reconstruction of gingiva and papillae
- compensation of mucosal defects

Liquid: Me Standard Modelling Liquid, Modelling Liquid, Modelling Liquid +

Shade code	REF	Quantity
G 1	252-090-20	20 g
G 2	252-091-20	20 g
G 3	252-092-20	20 g
G 4	252-093-20	20 g

CE⁰⁴⁸³



Incisal Value IV

Modifiers with higher opacity.

- opaque incisal modifiers where space is limited

Liquid: Modelling Liquid

Shade code	REF	Quantity
IV 1	252-280-20	20 g
IV 2	252-281-20	20 g
IV 3	252-282-20	20 g

CE⁰⁴⁸³



Value Modifier Bright Incisal opal VM B

- to determine / increase brightness in the incisal area

Liquid: Modelling Liquid

Shade code	REF	Quantity
VM B Incisal opal	252-284-20	20 g

CE⁰⁴⁸³

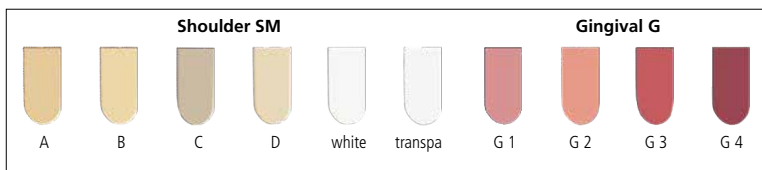

Value Modifier Bright Dentin opal VM B

- to determine the brightness of the dentin body without changing the color
- Liquid: Modelling Liquid

Shade code	REF	Quantity
VM B Dentin opal	252-287-20	20 g

CE 0483



Incisal Modifier Value IM V

- colored opalescent shade modifier to optimize the in-depth effect
 - to determine the intensity of incisal regions
- Liquid: Modelling Liquid

Shade code	REF	Quantity
IM V opal pure*	252-283-20	20 g
IM V opal pink	252-285-20	20 g
IM V opal violet	252-286-20	20 g

CE 0483

* pure opalescent modifiers



Transpa Modifier Value TM V

- natural light optical effects in the cervical and incisal area
- Liquid: Modelling Liquid

Shade code	REF	Quantity
TM V orange	252-288-20	20 g
TM V lemon	252-289-20	20 g
TM V salmon	252-290-20	20 g

CE 0483



Transpa Value TV

- transparent modifier, slightly opaque
- Liquid: Modelling Liquid

Shade code	REF	Quantity
TV transpa	252-291-20	20 g

CE 0483

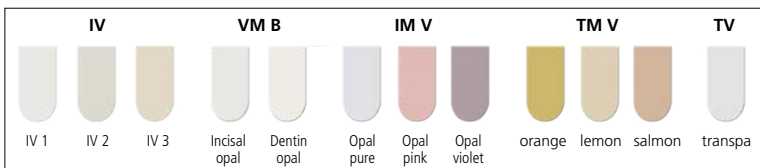

ceraMotion^{Me} – Metal ceramic



Chroma Concept Paste Opaque CC PO

Chroma opaque paste

- increases the reflection from deep in the ceramic
- produces all the hues of the shade guide of other suppliers (e.g. Vita 3D-Master** or Ivoclar-Chromascop***), as well as bleach colors

Liquid: Paste Liquid

Shade code	REF	Quantity
CC PO 1, bleach	252-541-03	3 g
CC PO 2	252-542-03	3 g
CC PO 3	252-543-03	3 g
CC PO 4	252-544-03	3 g

CE 0483

* Vita 3D-Master® is a registered trademark of Vita Zahnfabrik H. Rauter GmbH & Co.KG, 79704 Bad Säckingen, Germany.

** Ivoclar-Chromascop® is a registered trademark of Ivoclar Vivadent GmbH.



Chroma Concept Opaque CC O

Chroma opaque powder

- increases the reflection from deep in the ceramic
- produces all the hues of the shade guide of other suppliers (e.g. Vita 3D-Master** or Ivoclar-Chromascop***), as well as bleach colors

Liquid: Powder BOL Liquid

Shade code	REF	Quantity
CC O 1, bleach	252-221-20	20 g
CC O 2	252-222-20	20 g
CC O 3	252-223-20	20 g
CC O 4	252-224-20	20 g

CE 0483

* Vita 3D-Master® is a registered trademark of Vita Zahnfabrik H. Rauter GmbH & Co.KG, 79704 Bad Säckingen, Germany.

** Ivoclar-Chromascop® is a registered trademark of Ivoclar Vivadent GmbH.

Chroma Concept Dentin CC D

- pure or mixed for extending the color space
 - same opaque characteristics as dentin
 - produces all the hues of the shade guide of other suppliers (e.g. Vita 3D-Master** or Ivoclar-Chromascop***), as well as bleach colors
- Liquid: Me Standard Modelling Liquid, Modelling Liquid, Modelling Liquid +



Shade code	REF	Quantity
CC D 1, bleach	252-231-20	20 g
CC D 2, bleach	252-232-20	20 g
CC D 3	252-233-20	20 g
CC D 4	252-234-20	20 g
CC D 5	252-235-20	20 g
CC D 6	252-236-20	20 g
CC D 7	252-237-20	20 g
CC D 8	252-238-20	20 g
CC D 9	252-239-20	20 g
CC D 10	252-240-20	20 g
CC D 11	252-241-20	20 g
CC D 12	252-242-20	20 g

CE 0483

* Vita 3D-Master® is a registered trademark of Vita Zahnfabrik H. Rauter GmbH & Co.KG, 79704 Bad Säckingen, Germany.
** Ivoclar-Chromascop® is a registered trademark of Ivoclar Vivadent GmbH.

Chroma Concept Incisal CC I

Light incisal bleaching material

Liquid: Me Standard Modelling Liquid, Modelling Liquid, Modelling Liquid +



Shade code	REF	Quantity
CC I 1, bleach	252-245-20	20 g

CE 0483

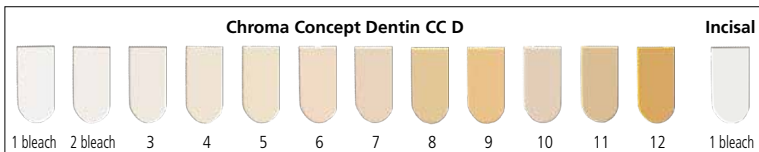

ceraMotion^{Me} – Metal ceramic



Touch Up Paste Opaque TU PO

Low-fusing opaque paste for corrections.

Firing temperature: 860 °C / 1580 °F

Liquid: Paste Liquid

Shade code	REF	Quantity
TU PO medium	252-250-03	3 g

CE 0483



Touch Up Base Dentin TU BD

Low-fusing material for correction and glaze firing in one.

- greater reliability due to highly condensed fitting surfaces

Liquid: Me Standard Modelling Liquid, Modelling Liquid, Modelling Liquid +

Shade code	REF	Quantity
TU BD light	252-251-20	20 g
TU BD medium	252-252-20	20 g
TU BD dark	252-253-20	20 g

CE 0483



Touch Up Dentin TU D

Low-fusing material for correction and glaze firing in one.

- highly condensed marginal ridges enhance the aesthetics

Liquid: Me Standard Modelling Liquid, Modelling Liquid, Modelling Liquid +

Shade code	REF	Quantity
TU D light	252-255-20	20 g
TU D medium	252-256-20	20 g
TU D dark	252-257-20	20 g

CE 0483



Touch Up Incisal TU I

Low-fusing material for correction and glaze firing in one.

- highly condensed marginal ridges enhance the aesthetics

Liquid: Me Standard Modelling Liquid, Modelling Liquid, Modelling Liquid +

Shade code	REF	Quantity
TU I medium	252-260-20	20 g
TU I opal	252-261-20	20 g
TU I transpa	252-262-20	20 g

CE 0483

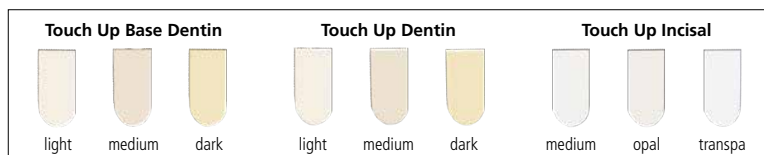

Touch Up Gingival TU G

- for corrections or additions in the gingival area

Liquid: Modelling Liquid

Shade code	REF	Quantity
TU G2	252-263-20	20 g
TU G4	252-264-20	20 g

CE 0483

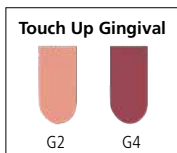

DENTAURUM
**ONLINE
SHOP**
shop.dentaurum.com



ceramotion[®] Me – Metal ceramic



Correction C

Low-fusing material, used for minor corrections.

Firing temperature: 860 °C / 1580 °F

Liquid: Me Standard Modelling Liquid, Modelling Liquid, Modelling Liquid +

Shade code	REF	Quantity
C transpa	252-095-03	3 g

CE 0483



Glaze GL

Glaze material, pure or for mixing with Stains and Body Stains.

Liquid: Stains Liquid

Shade code	REF	Quantity
GL transpa	252-270-02	2 g

CE 0483

Body Stains B ST

Stains for internal and external application

- for mixing with the glaze material
- individual color accentuation
- produces a particularly deep shade
- can be mixed up to 10 % in ceramic materials

Liquid: Stains Liquid



Shade code	REF	Quantity
B ST A	254-220-02	2 g
B ST B	254-221-02	2 g
B ST C	254-222-02	2 g



CE 0483

Stains ST

Stains for internal and external application

- for mixing with the glaze material
- individual color accentuation
- produces a particularly deep shade
- can be mixed up to 10 % in ceramic materials

Liquid: Stains Liquid



Shade code	REF	Quantity
ST 1 white	254-201-02	2 g
ST 2 vanilla	254-202-02	2 g
ST 3 yellow	254-203-02	2 g
ST 4 orange	254-204-02	2 g
ST 5 pink	254-205-02	2 g
ST 6 purple	254-206-02	2 g
ST 7 blue	254-207-02	2 g
ST 8 grey	254-208-02	2 g
ST 9 olive green	254-209-02	2 g
ST 10 olive yellow	254-210-02	2 g
ST 11 medium brown	254-211-02	2 g
ST 12 red brown	254-212-02	2 g
ST 13 black	254-213-02	2 g



CE 0483

Veneering ceramics

ceraMotion[®] Me – Metal ceramic



Me Standard Modelling Liquid

Standard liquid for mixing the ceramic materials of ceraMotion[®] Me.

REF 254-001-02	20 ml
REF 254-001-10	100 ml
REF 254-001-50	500 ml



Modelling Liquid

Standard liquid for mixing the ceramic materials.

REF 254-000-02	20 ml
REF 254-000-10	100 ml
REF 254-000-50	500 ml



Modelling Liquid +

Modelling liquid with slightly increased viscosity.

REF 254-002-02	20 ml
REF 254-002-10	100 ml
REF 254-002-50	500 ml



Paste Liquid

For adjusting the viscosity of the pastes.

REF 254-006-02	20 ml
REF 254-006-10	100 ml



Powder BOL Liquid

For mixing the powder bonder, opaque powder, powder liner.

REF 254-008-02	20 ml
REF 254-008-10	100 ml

Shoulder Liquid

For mixing the shoulder materials.

- increases the positional stability

REF 254-004-02	20 ml
REF 254-004-10	100 ml



Stains Liquid

For mixing the stains and the glaze/glaze material.

REF 254-010-02	20 ml
REF 254-010-10	100 ml



Modelling Liquid MV universal

- to increase plasticity
- to extend modeling properties

REF 299-150-40	20 ml
REF 299-150-80	100 ml



ceramotion[®] Me – Metal ceramic



Contrast Marker

For coloring mixed ceramic materials.

- for a better contrast when building up
- burns out without residue
- the same viscosity as the modelling liquid

Color	REF	Quantity
vanilla	254-300-02	20 ml
orange	254-301-02	20 ml
red	254-302-02	20 ml
blue	254-303-02	20 ml
green	254-304-02	20 ml

Veneering ceramics

ceraMotion® – Titanium ceramic



8 Shade Set

Set for veneering titanium frameworks and titanium alloys.
Contains the 8 most important A–D shades, opaque powder,
Base Dentins, Dentins, Incisal and effect materials.

REF 251-800-15	1 set
----------------	-------

CE 0483

Contents:

Designation	REF	Quantity
Paste Bonder PB	251-551-03	3 g
Opaque O A1	251-001-20	20 g
Opaque O A2	251-002-20	20 g
Opaque O A3	251-003-20	20 g
Opaque O A3,5	251-004-20	20 g
Opaque O B2	251-007-20	20 g
Opaque O B3	251-008-20	20 g
Opaque O C3	251-012-20	20 g
Opaque O D3	251-015-20	20 g
Base Dentin BD A1	251-021-20	20 g
Base Dentin BD A2	251-022-20	20 g
Base Dentin BD A3	251-023-20	20 g
Base Dentin BD A3,5	251-024-20	20 g
Base Dentin BD B2	251-027-20	20 g
Base Dentin BD B3	251-028-20	20 g
Base Dentin BD C3	251-032-20	20 g
Base Dentin BD D3	251-035-20	20 g
Dentin D A1	251-041-20	20 g
Dentin D A2	251-042-20	20 g
Dentin D A3	251-043-20	20 g
Dentin D A3,5	251-044-20	20 g
Dentin D B2	251-047-20	20 g

Designation	REF	Quantity
Dentin D B3	251-048-20	20 g
Dentin D C3	251-052-20	20 g
Dentin D D3	251-055-20	20 g
Incisal I 1	251-060-20	20 g
Incisal I 2	251-061-20	20 g
Incisal Opal IO 1	251-065-20	20 g
Incisal Opal IO 2	251-066-20	20 g
Incisal Transpa IT 1	251-070-20	20 g
Incisal Transpa IT 2	251-071-20	20 g
Transpa T transpa	251-075-20	20 g
Dentin Modifier Chroma DM C orange	251-114-20	20 g
Dentin Modifier Fluo DM F yellow	251-116-20	20 g
Incisal Modifier IM opal honey	251-121-20	20 g
Incisal Modifier IM opal white	251-122-20	20 g
Incisal Modifier IM opal blue	251-123-20	20 g
Glaze GL transpa	251-270-02	2 g
Correction C transpa	251-095-03	3 g
Modelling Liquid	254-000-10	100 ml
Paste Liquid	254-006-02	20 ml
Powder BOL Liquid	254-008-10	100 ml
Stains Liquid	254-010-02	20 ml
Shade Disc Incisal	254-100-00	1 piece



3 Shade Set

Set for veneering titanium frameworks and titanium alloys.
Contains the 3 most important A–B shades, opaque powder,
Base Dentins, Dentins, Incisal and effect materials.

REF 251-900-15	1 set
----------------	-------

CE 0483

Contents:

Designation	REF	Quantity
Opaque O A2	251-002-20	20 g
Opaque O A3	251-003-20	20 g
Opaque O B2	251-007-20	20 g
Base Dentin BD A2	251-022-20	20 g
Base Dentin BD B2	251-027-20	20 g
Dentin D A2	251-042-20	20 g
Dentin D B2	251-047-20	20 g
Incisal I 1	251-060-20	20 g
Incisal I 2	251-061-20	20 g

Designation	REF	Quantity
Incisal Transpa IT 1	251-070-20	20 g
Incisal Transpa IT 2	251-071-20	20 g
Transpa T transpa	251-075-20	20 g
Glaze GL transpa	251-270-02	2 g
Paste Bonder PB	251-551-03	3 g
Modelling Liquid	254-000-02	20 ml
Paste Liquid	254-006-02	20 ml
Stains Liquid	254-010-02	20 ml



Veneering ceramics

ceraMotion® – Titanium ceramic



Chroma Concept Set

Set for extending the color space of standard and bleach materials.

The set produces all the hues of the shade guide of other suppliers (e.g. Vita 3D-Master®* or Ivoclar-Chromascop®**).

Contains 17 ceramic materials including Opaque, Dentins and bleach modules.

REF 251-800-45

1 set

CE 0483

Contents:

Designation	REF	Quantity
Chroma Concept Opaque CC O 1, bleach	251-221-20	20 g
Chroma Concept Opaque CC O 2	251-222-20	20 g
Chroma Concept Opaque CC O 3	251-223-20	20 g
Chroma Concept Opaque CC O 4	251-224-20	20 g
Chroma Concept Dentin CC D 1, bleach	251-231-20	20 g
Chroma Concept Dentin CC D 2, bleach	251-232-20	20 g
Chroma Concept Dentin CC D 3	251-233-20	20 g
Chroma Concept Dentin CC D 4	251-234-20	20 g
Chroma Concept Dentin CC D 5	251-235-20	20 g

Designation	REF	Quantity
Chroma Concept Dentin CC D 6	251-236-20	20 g
Chroma Concept Dentin CC D 7	251-237-20	20 g
Chroma Concept Dentin CC D 8	251-238-20	20 g
Chroma Concept Dentin CC D 9	251-239-20	20 g
Chroma Concept Dentin CC D 10	251-240-20	20 g
Chroma Concept Dentin CC D 11	251-241-20	20 g
Chroma Concept Dentin CC D 12	251-242-20	20 g
Chroma Concept Incisal CC I 1, bleach	251-245-20	20 g
Shade Disc Chroma Concept / Bleach	254-102-00	1 piece

* Vita 3D-Master® is a registered trademark of Vita Zahnfabrik H. Rauter GmbH & Co.KG, 79704 Bad Säckingen, Germany.

** Ivoclar-Chromascop® is a registered trademark of Ivoclar Vivadent GmbH.

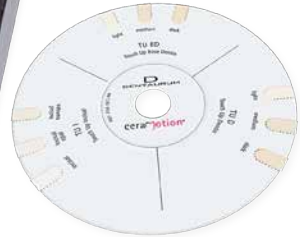

Touch Up Set

Set for facilitating finishing or corrections due to lower firing temperatures.

Contains 9 ceramic materials including Base Dentins, Dentins and Incisal materials.

REF 251-800-50	1 set
-----------------------	-------

CE 0483

Contents:

Designation	REF	Quantity
Touch Up Base Dentin TU BD light	251-251-20	20 g
Touch Up Base Dentin TU BD medium	251-252-20	20 g
Touch Up Base Dentin TU BD dark	251-253-20	20 g
Touch Up Dentin TU D light	251-255-20	20 g
Touch Up Dentin TU D medium	251-256-20	20 g

Designation	REF	Quantity
Touch Up Dentin TU D dark	251-257-20	20 g
Touch Up Incisal TU I medium	251-260-20	20 g
Touch Up Incisal TU I opal	251-261-20	20 g
Touch Up Incisal TU I transpa	251-262-20	20 g
Shade Disc Touch Up	254-103-00	1 piece



Stains Universal Set

Set containing 16 stains (3 opaque shades and 13 characterization shades) for internal and external effects.

REF 254-800-30

1 set

CE 0483

Contents:

Designation	REF	Quantity
Body Stains B ST A	254-220-02	2 g
Body Stains B ST B	254-221-02	2 g
Body Stains B ST C	254-222-02	2 g
Stains ST white	254-201-02	2 g
Stains ST vanilla	254-202-02	2 g
Stains ST yellow	254-203-02	2 g
Stains ST orange	254-204-02	2 g
Stains ST pink	254-205-02	2 g
Stains ST purple	254-206-02	2 g

Designation	REF	Quantity
Stains ST blue	254-207-02	2 g
Stains ST grey	254-208-02	2 g
Stains ST olive green	254-209-02	2 g
Stains ST olive yellow	254-210-02	2 g
Stains ST medium brown	254-211-02	2 g
Stains ST red brown	254-212-02	2 g
Stains ST black	254-213-02	2 g
Stains Liquid	254-010-02	20 ml
Shade Disc Stains	254-105-00	1 piece

Bonder B

Powder bonder

- produces an optimal bond strength between the titanium framework and ceramic

Liquid: Powder BOL Liquid

Shade code	REF (20 g)	REF (40 g)
B	251-550-20	251-550-40

CE 0483



Paste Bonder PB

Paste bonder

- produces an optimal bond strength between the titanium framework and ceramic

- direct use

- easy, uncomplicated application

Liquid: Paste Liquid

Shade code	REF (3 g)	REF (6 g)
PB	251-551-03	251-551-06

CE 0483



Opaque O

Opaque powder

- minimal layer thickness

- good and dense coverage of the metal substructure

Liquid: Powder BOL Liquid

Shade code	REF (20 g)	REF (40 g)
O A1	251-001-20	251-001-40
O A2	251-002-20	251-002-40
O A3	251-003-20	251-003-40
O A3,5	251-004-20	251-004-40
O A4	251-005-20	251-005-40
O B1	251-006-20	251-006-40
O B2	251-007-20	251-007-40
O B3	251-008-20	251-008-40
O B4	251-009-20	251-009-40
O C1	251-010-20	251-010-40
O C2	251-011-20	251-011-40
O C3	251-012-20	251-012-40
O C4	251-013-20	251-013-40
O D2	251-014-20	251-014-40
O D3	251-015-20	251-015-40
O D4	251-016-20	251-016-40

CE 0483



ceraMotion®_{Ti} – Titanium ceramic



Opaque Modifier OM

- customized accentuation of the opaque powder

Liquid: Powder BOL Liquid

Shade code	REF	Quantity
OM gingival	251-018-20	20 g
OM orange	251-019-20	20 g

CE⁰⁴⁸³

Base Dentin BD

- has a higher opacity than Dentin
- diffusing effect
- three-dimensional depth effect (after finishing)
- support of the actual tooth shade (even if there is unfavorable space availability)
- increases reflection from deep in the ceramic

Liquid: Modelling Liquid, Modelling Liquid +

Shade code	REF (20 g)	REF (40 g)
BD A1	251-021-20	251-021-40
BD A2	251-022-20	251-022-40
BD A3	251-023-20	251-023-40
BD A3,5	251-024-20	251-024-40
BD A4	251-025-20	251-025-40
BD B1	251-026-20	251-026-40
BD B2	251-027-20	251-027-40
BD B3	251-028-20	251-028-40
BD B4	251-029-20	251-029-40
BD C1	251-030-20	251-030-40
BD C2	251-031-20	251-031-40
BD C3	251-032-20	251-032-40
BD C4	251-033-20	251-033-40
BD D2	251-034-20	251-034-40
BD D3	251-035-20	251-035-40
BD D4	251-036-20	251-036-40



CE 0483

Base Dentin Modifier BDM

Effect material with increased opacity

- produces depth of shade
- controls the brightness value
- reproduction of natural effects in the dental, proximal and mamelon regions

Liquid: Modelling Liquid, Modelling Liquid +

Shade code	REF	Quantity
BDM salmon	251-101-20	20 g
BDM caramel	251-102-20	20 g
BDM ochre	251-103-20	20 g
BDM ivory	251-104-20	20 g
BDM lemon	251-105-20	20 g
BDM vanilla	251-106-20	20 g
BDM brown	251-107-20	20 g



CE 0483



ceraMotion[®]_{Ti} – Titanium ceramic



Dentin D

Standard dentin

- produces the primary shade effect
- natural fluorescence
- prism effects

Liquid: Modelling Liquid, Modelling Liquid +

Shade code	REF (20 g)	REF (40 g)
D A1	251-041-20	251-041-40
D A2	251-042-20	251-042-40
D A3	251-043-20	251-043-40
D A3,5	251-044-20	251-044-40
D A4	251-045-20	251-045-40
D B1	251-046-20	251-046-40
D B2	251-047-20	251-047-40
D B3	251-048-20	251-048-40
D B4	251-049-20	251-049-40
D C1	251-050-20	251-050-40
D C2	251-051-20	251-051-40
D C3	251-052-20	251-052-40
D C4	251-053-20	251-053-40
D D2	251-054-20	251-054-40
D D3	251-055-20	251-055-40
D D4	251-056-20	251-056-40

CE⁰⁴⁸³

Incisal allocation table			
Dentin shade	Incisal Standard	Incisal Opal	Incisal Transpa
A1, A2, B1	I 1	IO 1	IT 1
A3, A3,5, B2, B3, B4, C1, C2, C3, D2, D3, D4	I 2	IO 2	IT 2
A4, C4	I 3	IO 3	IT 3

Dentin Modifier Chroma DM C

- controls the intensity of the respective hue
 - increases the depth of shade, even with a reduced layer thickness
- Liquid: Modelling Liquid, Modelling Liquid +

Shade code	REF	Quantity
DM C A	251-111-20	20 g
DM C B	251-112-20	20 g
DM C C	251-113-20	20 g
DM C orange	251-114-20	20 g

CE 0483



Dentin Modifier Fluo DM F

Dentin effect material with increased fluorescence

- controls the brightness value
- Liquid: Modelling Liquid, Modelling Liquid +

Shade code	REF	Quantity
DM F cream	251-115-20	20 g
DM F yellow	251-116-20	20 g
DM F orange	251-117-20	20 g

CE 0483

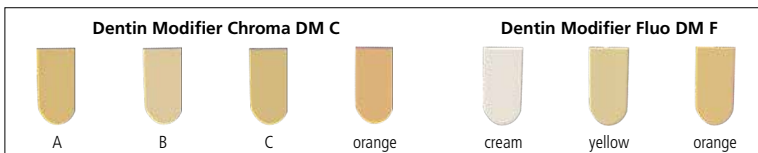

Veneering ceramics

ceraMotion® – Titanium ceramic



Incisal I

Standard incisal material

- application in the incisal region

Liquid: Modelling Liquid, Modelling Liquid +

Shade code	REF (20 g)	REF (40 g)
I 1	251-060-20	251-060-40
I 2	251-061-20	251-061-40
I 3	251-062-20	251-062-40

CE 0483



Incisal Opal IO

- for alternate layering incisally
- opalescent: bluish effect in reflected light
- orange-colored effect in light transmitted through the ceramic
- enhances the natural light refraction
- application in the incisal region

Liquid: Modelling Liquid, Modelling Liquid +

Shade code	REF (20 g)	REF (40 g)
IO 1	251-065-20	251-065-40
IO 2	251-066-20	251-066-40
IO 3	251-067-20	251-067-40

CE 0483



Incisal Transpa IT

- increased transparency in the materials
- application in the incisal region

Liquid: Modelling Liquid, Modelling Liquid +

Shade code	REF (20 g)	REF (40 g)
IT 1	251-070-20	251-070-40
IT 2	251-071-20	251-071-40
IT 3	251-072-20	251-072-40

CE 0483

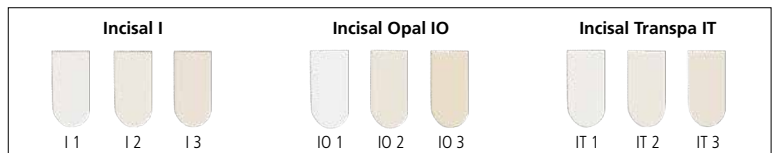

Transpa T

- highly transparent material
 - application in the incisal region, as required
- Liquid: Modelling Liquid, Modelling Liquid +

Shade code	REF (20 g)	REF (40 g)
T transpa	251-075-20	251-075-40

CE 0483



Incisal Modifier IM

- enhances the natural light refraction
 - for alternate layering incisally
 - application in the incisal region
- Liquid: Modelling Liquid, Modelling Liquid +

Shade code	REF	Quantity
IM opal honey	251-121-20	20 g
IM opal white	251-122-20	20 g
IM opal blue	251-123-20	20 g
IM grey	251-124-20	20 g
IM opal grey	251-125-20	20 g

CE 0483

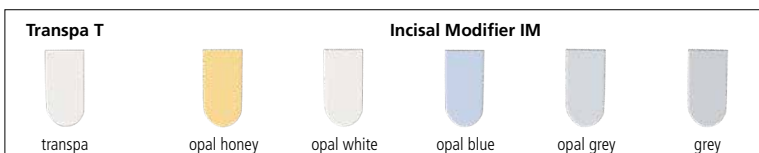

Veneering ceramics

ceraMotion[®] Ti – Titanium ceramic



Shoulder SM

Shoulder material

With the shoulder material "white" it is possible to individually mix all shade nuances from A1 to D4 by following the information in the mixing table.

By adding the shoulder material "transparent", the translucence is increased in the shoulder.

Liquid: Shoulder Liquid

Shade code	REF	Quantity
SM A	251-081-20	20 g
SM B	251-082-20	20 g
SM C	251-083-20	20 g
SM D	251-084-20	20 g
SM white	251-085-20	20 g
SM transpa	251-086-20	20 g

CE⁰⁴⁸³



Gingival G

- build-up and reconstruction of gingiva and papillae
- compensation of mucosal defects

Liquid: Modelling Liquid, Modelling Liquid +

Shade code	REF	Quantity
G 1	251-090-20	20 g
G 2	251-091-20	20 g
G 3	251-092-20	20 g
G 4	251-093-20	20 g

CE⁰⁴⁸³

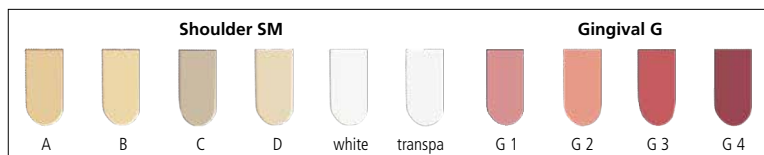

Chroma Concept Opaque CC O

Chroma opaque powder

- increases the reflection from deep in the ceramic
- can be used with patients who have a lighter or bleached tooth shade
- produces all the hues of the shade guide of other suppliers (e.g. Vita 3D-Master[®]* or Ivoclar-Chromascop[®]**)

Liquid: Powder BOL Liquid

Shade code	REF	Quantity
CC O 1, bleach	251-221-20	20 g
CC O 2	251-222-20	20 g
CC O 3	251-223-20	20 g
CC O 4	251-224-20	20 g



CE 0483

* Vita 3D-Master[®] is a registered trademark of Vita Zahnfabrik H. Rauter GmbH & Co.KG, 79704 Bad Säckingen, Germany.

** Ivoclar-Chromascop[®] is a registered trademark of Ivoclar Vivadent GmbH.

Chroma Concept Dentin CC D

- pure or mixed, for extending the color space
- same opaque characteristics as dentin
- white and light dentin bleaching materials
- produces all the hues of the shade guide of other suppliers (e.g. Vita 3D-Master[®]* or Ivoclar-Chromascop[®]**)

Liquid: Modelling Liquid, Modelling Liquid +

Shade code	REF	Quantity
CC D 1, bleach	251-231-20	20 g
CC D 2, bleach	251-232-20	20 g
CC D 3	251-233-20	20 g
CC D 4	251-234-20	20 g
CC D 5	251-235-20	20 g
CC D 6	251-236-20	20 g
CC D 7	251-237-20	20 g
CC D 8	251-238-20	20 g
CC D 9	251-239-20	20 g
CC D 10	251-240-20	20 g
CC D 11	251-241-20	20 g
CC D 12	251-242-20	20 g



CE 0483

* Vita 3D-Master[®] is a registered trademark of Vita Zahnfabrik H. Rauter GmbH & Co.KG, 79704 Bad Säckingen, Germany.

** Ivoclar-Chromascop[®] is a registered trademark of Ivoclar Vivadent GmbH.

Chroma Concept Incisal CC I

Light incisal bleaching material

Liquid: Modelling Liquid, Modelling Liquid +

Shade code	REF	Quantity
CC I 1, bleach	251-245-20	20 g



CE 0483

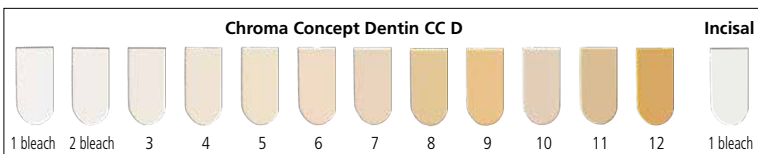

ceraMotion[®]_{Ti} – Titanium ceramic



Touch Up Base Dentin TU BD

Low-fusing material for correction and glaze firing in one.

- greater reliability due to highly condensed fitting surfaces

Liquid: Modelling Liquid, Modelling Liquid +

Shade code	REF	Quantity
TU BD light	251-251-20	20 g
TU BD medium	251-252-20	20 g
TU BD dark	251-253-20	20 g

CE 0483



Touch Up Dentin TU D

Low-fusing material for correction and glaze firing in one.

- highly condensed marginal ridges enhance the aesthetics

Liquid: Modelling Liquid, Modelling Liquid +

Shade code	REF	Quantity
TU D light	251-255-20	20 g
TU D medium	251-256-20	20 g
TU D dark	251-257-20	20 g

CE 0483



Touch Up Incisal TU I

Low-fusing material for correction and glaze firing in one.

- highly condensed marginal ridges enhance the aesthetics

Liquid: Modelling Liquid, Modelling Liquid +

Shade code	REF	Quantity
TU I medium	251-260-20	20 g
TU I opal	251-261-20	20 g
TU I transpa	251-262-20	20 g

CE 0483

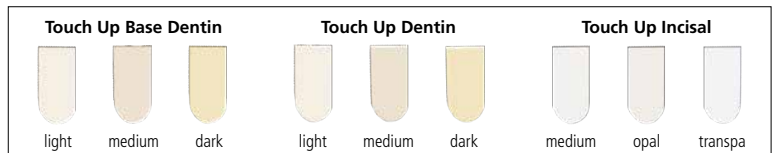

Correction C

Low-fusing material, used for minor corrections.

Firing temperature: 715 °C / 1319 °F

Liquid: Modelling Liquid, Modelling Liquid +

Shade code	REF	Quantity
C transpa	251-095-03	3 g

CE 0483



Glaze GL

Glaze material, pure or for mixing with Stains and Body Stains.

Liquid: Stains Liquid

Shade code	REF	Quantity
GL transpa	251-270-02	2 g

CE 0483



ceraMotion[®] Ti – Titanium ceramic



Body Stains B ST

Stains for internal and external application

- for mixing with the glaze material
- individual color accentuation
- produces a particularly deep shade
- can be mixed up to 10 % in ceramic materials

Liquid: Stains Liquid

Shade code	REF	Quantity
● B ST A	254-220-02	2 g
● B ST B	254-221-02	2 g
● B ST C	254-222-02	2 g

CE⁰⁴⁸³



Stains ST

Stains for internal and external application

- for mixing with the glaze material
- individual color accentuation
- produces a particularly deep shade
- can be mixed up to 10 % in ceramic materials

Liquid: Stains Liquid

Shade code	REF	Quantity
○ ST 1 white	254-201-02	2 g
● ST 2 vanilla	254-202-02	2 g
● ST 3 yellow	254-203-02	2 g
● ST 4 orange	254-204-02	2 g
● ST 5 pink	254-205-02	2 g
● ST 6 purple	254-206-02	2 g
● ST 7 blue	254-207-02	2 g
● ST 8 grey	254-208-02	2 g
● ST 9 olive green	254-209-02	2 g
● ST 10 olive yellow	254-210-02	2 g
● ST 11 medium brown	254-211-02	2 g
● ST 12 red brown	254-212-02	2 g
● ST 13 black	254-213-02	2 g

CE⁰⁴⁸³

Modelling Liquid

Standard liquid for mixing the ceramic materials.

REF 254-000-02	20 ml
REF 254-000-10	100 ml
REF 254-000-50	500 ml



Modelling Liquid +

Modelling liquid with slightly increased viscosity.

REF 254-002-02	20 ml
REF 254-002-10	100 ml
REF 254-002-50	500 ml



Paste Liquid

For adjusting the viscosity of the pastes.

REF 254-006-02	20 ml
REF 254-006-10	100 ml



Powder BOL Liquid

For mixing the powder bonder, opaque powder, powder liner.

REF 254-008-02	20 ml
REF 254-008-10	100 ml



Shoulder Liquid

For mixing the shoulder materials.

- increases the positional stability

REF 254-004-02	20 ml
REF 254-004-10	100 ml



Stains Liquid

For mixing the stains and the glaze/glaze material.

REF 254-010-02	20 ml
REF 254-010-10	100 ml



ceraMotion®_{Ti} – Titanium ceramic



Contrast Marker

For coloring mixed ceramic materials.

- for a better contrast when building up
- burns out without residue
- the same viscosity as the modelling liquid

Color	REF	Quantity
vanilla	254-300-02	20 ml
orange	254-301-02	20 ml
red	254-302-02	20 ml
blue	254-303-02	20 ml
green	254-304-02	20 ml

Veneering ceramics

ceraMotion[®] Lf – Low-fusing ceramic



8 Shade Set

Set for veneering alloys that have a high CTE value (CTE range of 15.9 to 17.0 · 10⁻⁶ K⁻¹ at 25–500 °C / 77–932 °F).

Contains the 8 most important A–D shades, Paste Opaque, Base Dentins, Dentins, Incisal and effect materials.

REF 253-800-10 1 set

CE 0483

Contents:

Designation	REF	Quantity
Paste Opaque PO base	253-550-03	3 g
Paste Opaque PO A1	253-501-03	3 g
Paste Opaque PO A2	253-502-03	3 g
Paste Opaque PO A3	253-503-03	3 g
Paste Opaque PO A3,5	253-504-03	3 g
Paste Opaque PO B2	253-507-03	3 g
Paste Opaque PO B3	253-508-03	3 g
Paste Opaque PO C3	253-512-03	3 g
Paste Opaque PO D3	253-515-03	3 g
Base Dentin BD 1	253-021-20	20 g
Base Dentin BD 2	253-022-20	20 g
Base Dentin BD 3	253-023-20	20 g
Base Dentin BD 4	253-024-20	20 g
Base Dentin BD 5	253-025-20	20 g
Base Dentin BD 7	253-027-20	20 g
Base Dentin BD 9	253-029-20	20 g
Dentin D A1	253-041-20	20 g
Dentin D A2	253-042-20	20 g

Designation	REF	Quantity
Dentin D A3	253-043-20	20 g
Dentin D A3,5	253-044-20	20 g
Dentin D B2	253-047-20	20 g
Dentin D B3	253-048-20	20 g
Dentin D C3	253-052-20	20 g
Dentin D D3	253-055-20	20 g
Incisal I 1	253-060-20	20 g
Incisal I 2	253-061-20	20 g
Incisal Opal IO 1	253-065-20	20 g
Incisal Opal IO 2	253-066-20	20 g
Transpa T transpa	253-075-20	20 g
Dentin Modifier Fluo DM F yellow	253-116-20	20 g
Glaze GL transpa	253-270-02	2 g
Correction C transpa	253-095-03	3 g
Modelling Liquid	254-000-10	100 ml
Paste Liquid	254-006-02	20 ml
Stains Liquid	254-010-02	20 ml
Shade Disc Incisal	254-100-00	1 piece

Paste Opaque PO

Opaque paste

- can be universally used with all non-precious and LF precious metal alloys, as well as for galvano gold
- slow cooling is not required with any firing cycles
- good, dense coverage of the metal substructure
- easy, uncomplicated application
- silky glaze

The opaque paste PO base was specially developed for precious metal alloys with a copper content and ensures complete coverage of the framework and shade stability.

Liquid: Paste Liquid



Shade code	REF	Quantity
PO base	253-550-03	3 g
PO A1	253-501-03	3 g
PO A2	253-502-03	3 g
PO A3	253-503-03	3 g
PO A3,5	253-504-03	3 g
PO A4	253-505-03	3 g
PO B1	253-506-03	3 g
PO B2	253-507-03	3 g
PO B3	253-508-03	3 g
PO B4	253-509-03	3 g
PO C1	253-510-03	3 g
PO C2	253-511-03	3 g
PO C3	253-512-03	3 g
PO C4	253-513-03	3 g
PO D2	253-514-03	3 g
PO D3	253-515-03	3 g
PO D4	253-516-03	3 g

CE 0483

Paste Opaque Modifier POM

- customized accentuation of the opaque paste

Liquid: Paste Liquid



Shade code	REF	Quantity
POM gingival	253-520-03	3 g
POM orange	253-521-03	3 g

CE 0483



Veneering ceramics

ceraMotion[®] Lf – Low-fusing ceramic



Base Dentin BD

- has a higher opacity than Dentin
- diffusing effect
- three-dimensional depth effect (after finishing)
- support of the actual tooth shade (even if there is unfavorable space availability)
- increases reflection from deep in the ceramic

Liquid: Modelling Liquid, Modelling Liquid +

Shade code	REF	Quantity
BD 1	253-021-20	20 g
BD 2	253-022-20	20 g
BD 3	253-023-20	20 g
BD 4	253-024-20	20 g
BD 5	253-025-20	20 g
BD 6	253-026-20	20 g
BD 7	253-027-20	20 g
BD 8	253-028-20	20 g
BD 9	253-029-20	20 g
BD 10	253-030-20	20 g

CE⁰⁴⁸³

Mixing instructions															
A1	A2	A3	A3,5	A4	B1	B2	B3	B4	C1	C2	C3	C4	D2	D3	D4
BD1	1/3 BD1 + 2/3 BD3	BD2	BD3	1/3 BD1 + 2/3 DMCA	BD4	2/3 BD4 + 1/3 BD5	BD5	2/3 BD1 + 1/3 DMCB	BD6	1/3 BD6 + 2/3 BD7	BD7	1/3 BD7 + 2/3 DMC	BD8	BD9	BD10

Dentin D

Standard dentin

- produces the primary shade effect
- natural fluorescence
- prism effects

Liquid: Modelling Liquid, Modelling Liquid +



Shade code	REF	Quantity
D A1	253-041-20	20 g
D A2	253-042-20	20 g
D A3	253-043-20	20 g
D A3,5	253-044-20	20 g
D A4	253-045-20	20 g
D B1	253-046-20	20 g
D B2	253-047-20	20 g
D B3	253-048-20	20 g
D B4	253-049-20	20 g
D C1	253-050-20	20 g
D C2	253-051-20	20 g
D C3	253-052-20	20 g
D C4	253-053-20	20 g
D D2	253-054-20	20 g
D D3	253-055-20	20 g
D D4	253-056-20	20 g

CE 0483

Incisal allocation table		
Dentin shade	Incisal Standard	Incisal Opal
A1, A2, B1	I 1	IO 1
A3, A3,5, B2, B3, B4, C1, C2, C3, D2, D3, D4	I 2	IO 2
A4, C4	I 3	IO 3

ceraMotion^{LF} – Low-fusing ceramic



Dentin Modifier Chroma DM C

- controls the intensity of the respective hue
 - increases the depth of shade, even with a reduced layer thickness
- Liquid: Modelling Liquid, Modelling Liquid +

Shade code	REF	Quantity
DM C A	253-111-20	20 g
DM C B	253-112-20	20 g
DM C C	253-113-20	20 g

CE 0483



Dentin Modifier Fluo DM F

- Dentin effect material with increased fluorescence
- controls the brightness value
- Liquid: Modelling Liquid, Modelling Liquid +

Shade code	REF	Quantity
DM F cream	253-115-20	20 g
DM F yellow	253-116-20	20 g
DM F orange	253-117-20	20 g

CE 0483

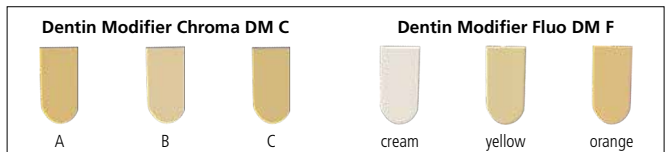

Incisal I

Standard incisal material

- application in the incisal region

Liquid: Modelling Liquid, Modelling Liquid +

Shade code	REF	Quantity
I 1	253-060-20	20 g
I 2	253-061-20	20 g
I 3	253-062-20	20 g

CE 0483



Incisal Opal IO

- for alternate layering incisally
- opalescent: bluish effect in reflected light
- orange-colored effect in light transmitted through the ceramic
- enhances the natural light refraction
- application in the incisal region

Liquid: Modelling Liquid, Modelling Liquid +

Shade code	REF	Quantity
IO 1	253-065-20	20 g
IO 2	253-066-20	20 g
IO 3	253-067-20	20 g

CE 0483



Transpa T

- highly transparent material
- application in the incisal region, as required

Liquid: Modelling Liquid, Modelling Liquid +

Shade code	REF	Quantity
T transpa	253-075-20	20 g

CE 0483

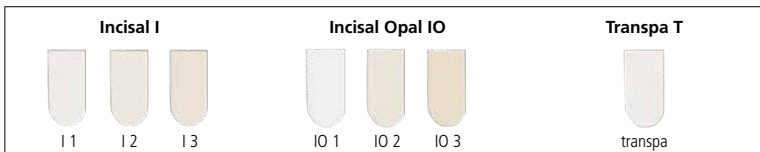

ceraMotion[®] Lf – Low-fusing ceramic



Incisal Modifier IM

- can be layered alternately in the incisal area
- increases the natural optical refraction
- application in incisal area

Shade code	REF	Quantity
IM opal honey	253-121-20	20 g
IM opal blue	253-123-20	20 g
IM opal grey	253-125-20	20 g

CE 0483



Shoulder SM

Shoulder material

With the shoulder material “white” it is possible to individually mix all shade nuances from A1 to D4 by following the information in the mixing table.

By adding the shoulder material “transparent”, the translucence is increased in the shoulder.

Liquid: Shoulder Liquid

Shade code	REF	Quantity
SM A	253-081-20	20 g
SM B	253-082-20	20 g
SM C	253-083-20	20 g
SM D	253-084-20	20 g
SM white	253-085-20	20 g
SM transpa	253-086-20	20 g

CE 0483



Gingival G

- build-up and reconstruction of gingiva and papillae
- compensation of mucosal defects

Liquid: Modelling Liquid, Modelling Liquid +

Shade code	REF	Quantity
G light	253-091-20	20 g
G dark	253-092-20	20 g

CE 0483

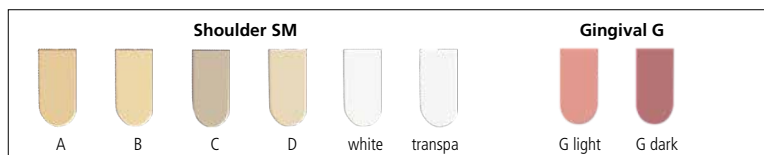

Chroma Concept Paste Opaque CC PO

Chroma opaque paste

- increases the reflection from deep in the ceramic
- can be used with patients who have a lighter or bleached tooth shade

Liquid: Paste Liquid

Shade code	REF	Quantity
CC PO 1, bleach	253-541-03	3 g

CE 0483



Chroma Concept Dentin CC D

- pure or mixed, for extending the color space
- same opaque characteristics as Dentin

- white and light dentin bleaching materials

Liquid: Modelling Liquid, Modelling Liquid +

Shade code	REF	Quantity
CC D 1, bleach	253-231-20	20 g
CC D 2, bleach	253-232-20	20 g

CE 0483



Chroma Concept Incisal CC I

Light incisal bleaching material

Liquid: Modelling Liquid, Modelling Liquid +

Shade code	REF	Quantity
CC I 1, bleach	253-245-20	20 g

CE 0483

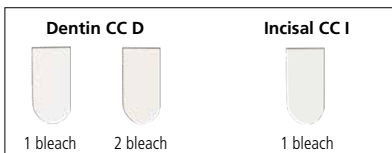

Veneering ceramics

ceraMotion[®] Lf – Low-fusing ceramic



Correction C

Low-fusing material, used for minor corrections.

Firing temperature: 745 °C / 1373 °F

Liquid: Modelling Liquid, Modelling Liquid +

Shade code	REF	Quantity
C transpa	253-095-03	3 g

CE 0483



Glaze GL

Glaze material, pure or for mixing with Lf Stains and Lf Body Stains.

Liquid: Stains Liquid

Shade code	REF	Quantity
GL transpa	253-270-02	2 g

CE 0483

Lf Body Stains LF BST

Stains for internal and external application

- for mixing with the glaze material
- individual color accentuation
- produces a particularly deep shade
- can be mixed up to 10 % in ceramic materials

Liquid: Stains Liquid



Shade code	REF	Quantity
LF BST A	253-620-02	2 g
LF BST B	253-621-02	2 g
LF BST C	253-622-02	2 g



CE 0483

Lf Stains LF ST

Stains for internal and external application

- for mixing with the glaze material
- individual color accentuation
- produces a particularly deep shade
- can be mixed up to 10 % in ceramic materials

Liquid: Stains Liquid



Shade code	REF	Quantity
LF ST 1 white	253-601-02	2 g
LF ST 4 orange	253-604-02	2 g
LF ST 7 blue	253-607-02	2 g
LF ST 9 olive green	253-609-02	2 g
LF ST 12 red brown	253-612-02	2 g
LF ST 13 black	253-613-02	2 g



CE 0483



Veneering ceramics

ceraMotion[®] L_f – Low-fusing ceramic



Modelling Liquid

Standard liquid for mixing the ceramic materials.

REF 254-000-02	20 ml
REF 254-000-10	100 ml
REF 254-000-50	500 ml



Modelling Liquid +

Modelling liquid with slightly increased viscosity.

REF 254-002-02	20 ml
REF 254-002-10	100 ml
REF 254-002-50	500 ml



Paste Liquid

For adjusting the viscosity of the pastes.

REF 254-006-02	20 ml
REF 254-006-10	100 ml



Shoulder Liquid

For mixing the shoulder materials.

- increases the positional stability

REF 254-004-02	20 ml
REF 254-004-10	100 ml



Stains Liquid

For mixing the stains and the glaze/glaze material.

REF 254-010-02	20 ml
REF 254-010-10	100 ml

Contrast Marker

For coloring mixed ceramic materials.

- for a better contrast when building up
- burns out without residue
- the same viscosity as the modelling liquid



Color	REF	Quantity
vanilla	254-300-02	20 ml
orange	254-301-02	20 ml
red	254-302-02	20 ml
blue	254-303-02	20 ml
green	254-304-02	20 ml

ceraMotion® – Ceramic accessories



Shade Disc Incisal

Shade disc for incisal materials.

REF 254-100-00

1 piece



Shade Disc Modifier

Shade disc for effect materials.

REF 254-101-00

1 piece



Shade Disc Value Concept

Shade disc for Value Concept materials.

REF 254-106-00

1 piece



Shade Disc Chroma Concept / Bleach

Shade disc for Chroma Concept materials.

REF 254-102-00

1 piece

Shade Disc Touch Up

Shade disc for Touch Up materials.

REF 254-103-00

1 piece



Shade Disc Shoulder / Gingival

Shade disc for shoulder and gingival materials.

REF 254-104-00

1 piece



Shade Disc Stains

Shade disc for Stains.

REF 254-105-00

1 piece



A–D Shade Guide

Shade guide for ceraMotion® ceramic materials.

REF 260-300-20

1 piece



Veneering ceramics

ceraMotion® – Ceramic accessories



Opaque brush no. 6

REF 260-907-10

1 piece



Shade sample former

For easy preparation of bake samples.

REF 260-315-00

1 piece



Firing tray with holders

REF 260-300-03

1 piece



Holders for firing tray

REF 260-300-13

6 pieces



Carbon fibre chips

• for purge of ceramic furnaces

REF 260-317-00

10 pieces



Glass instrument for bonder and opaque

REF 291-000-00

1 piece



SM-Isosit

- to smooth out and seal at the same time
- to isolate plaster from ceramics and ceramics from ceramics

REF 260-324-01

20 ml

CoCr blanks	Page	126
Titanium blanks	Page	128
Wax blanks	Page	130
Zirconium oxide blanks	Page	131
Zirconium oxide / Coloring liquids	Page	136
Zirconium oxide – accessories	Page	139



CAD/CAM materials.



DENTAURUM
**ONLINE
SHOP**
shop.dentaurum.com



Premium quality for every requirement.

remanium®
star MD I + II

rematitan®
Ti2+Ti5

STAR *WAX*

High-tech CoCr bonding alloy for CAD/CAM milling systems.

remanium® star MD I: Using specific metallurgical processes, a fine-grained, homogeneous microstructure can be produced.

In addition to improving the mechanical properties, the hot isostatic pressing process also guarantees that no porosity or contraction cavities occur.

Optimized standard version in implant quality.

A distinguishing feature of remanium® star MD II is its homogeneous composition which guarantees very high strength (type 4) and high ductility. Good laser weldability and proven excellent ceramic bonding are further properties which provide the basis for the high degree of safety potential.

Titanium of low hardness.

Pure titanium blank for all applications in crown and bridge work. Highly biocompatible and gentle on the tools during milling.

For high demands.

Titanium alloy (Ti 6AL 4V) with increased mechanical hardness. Particularly suitable for long-span, delicate framework structures and for implant work.

Wax milling made easy.

Wax blanks with excellent milling properties for the manufacture of crowns and bridges or cast partial dentures using the CAD/Vest process. Can be processed on all milling machines suitable for milling blanks with standard dimensions.

StarWax Blank grey is ideal for CAD/Vest crowns and bridges to be pressed or cast.

StarWax Blank blue is ideal for CAD/Vest cast partial dentures to be cast.



ceraMotion® One Touch Concept.

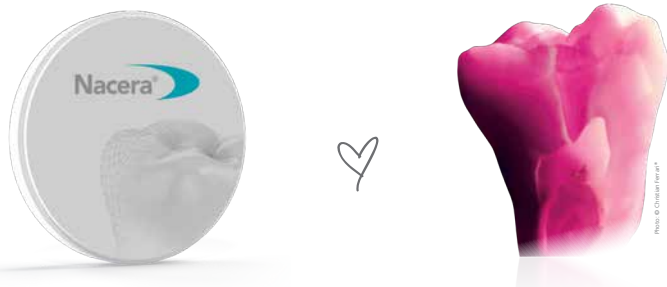

The ceraMotion® One Touch Concept combines two strong brands – Nacera® and ceraMotion®.

Nacera®* and ceraMotion® – two strong brands combined to form a unique product range for all indications and processing techniques for the manufacture of all-ceramic restorations made of zirconium oxide. They are individually tailored to the needs and requirements of the user.



Be it opaque, highly translucent, ultra-highly translucent or single- or multi-layered – Nacera®, a high-performance ceramics made of zirconium oxide, is available for many indications. The high-quality and extremely precise milling blanks are manufactured in Germany. They can be used to create sophisticated, natural dental restorations.



ceraMotion® Zr veneering ceramics unite the highest demands on aesthetics with the most modern materials technology within a logical system. The resulting products are developed and produced in our own company. The One Touch Concept combines two strong brands – Nacera® and ceraMotion®.

* Nacera® is a registered trademark of Doceram Medical Ceramics GmbH, Germany.

Zirconium oxide. Shade stability. Aesthetics.

- White zirconium oxide, semi-translucent and highly translucent.
- Highly translucent colored zirconium oxide in the 16 V-classic shades (A1–D4 + 2 bleach colors).
- Multi-layered and highly translucent zirconium oxide in 4 basic colors (A–D) Light & Dark.
- Multi-layered and ultra-highly translucent zirconium oxide in 3 basic colors (A–C) Light & Dark.
- Veneering porcelain concept for build-up / cut back / staining and minimal stratification technique.
- Unique 2D and 3D pastes for a quick, aesthetic finish to fully-anatomical restorations.
- Coloring liquids in the classic V-shades (A1–D4) and shade modifiers for the dipping and brush technique.
- Nacera® Blue X liquid to increase translucency in highly translucent zirconium oxide.



CoCr blanks



remanium® star MD I milling blank

ø 98.4 mm

Proven high-tech CoCr bonding alloy for CAD/CAM milling systems.

Powder metallurgical manufacture with extremely homogeneous structure.

Advantages:

- proven remanium® star composition
- certified and time-tested base material for all applications in crown and bridge work
- hot isostatically compressed, 100 % free of porosity and contraction cavities
- fine-grained microstructure of the milling discs
- homogeneous structure of the material facilitates uniform, easy machinability on the respective milling machine
- maximum strength Type 5, DIN EN ISO 22674
- ideal for ceramic veneering using the conventional CTE range
- excellent laser weldability

Indication: for all constructions manufactured using milling technique such as crowns, bridges, supra-structures, ceramic bonding with suitable ceramics

Norm: DIN EN ISO 9693, DIN EN ISO 22674

Thickness	Border	REF	Quantity
8 mm	without	102-650-00	1 piece
10 mm	without	102-651-00	1 piece
12 mm	10 mm	102-652-00	1 piece
13.5 mm	10 mm	102-653-00	1 piece
15 mm	10 mm	102-654-00	1 piece



Special sizes for remanium® star MD I:
Special sizes with a thickness of up to 25 mm and a minimum purchase quantity of 50 blanks are available on request.
Please note the extended delivery time: 8–10 weeks.

remanium® star is also processed as SLM powder for the laser-melting technique by leading suppliers.
Information is available on request!

Technical data

0.2% Yield strength $R_{p0.2}$	635 MPa
Tensile strength R_m	1120 MPa
Hardness	330 HV 10
Elongation A_5	10.2 %
Modulus of elasticity E	230 GPa
Density	8.6 g/cm ³
CTE 25–500 °C / 77–932 °F	14.1 x 10 ⁻⁶ K ⁻¹
Solidus temperature	1320 °C / 2408 °F
Liquidus temperature	1420 °C / 2588 °F

Composition (percentage by mass)

Co	Cr	W	Si
60.5	28.0	9.0	1.5

Additional elements < 1 %: Fe, Mn, N, Nb

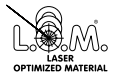

remanium® star MD II milling blank

∅ 98.4 mm

Proven CoCr bonding alloy for CAD/CAM milling systems. Optimized casting structure in implant quality.

Advantages:

- proven remanium® star composition
- certified and time-tested base material for all applications in crown and bridge work
- very high ductility
- very high strength Type 4, DIN EN ISO 22674
- ideal for ceramic veneering using the conventional CTE range
- excellent laser weldability

Indication: for all constructions manufactured using milling technique such as crowns, bridges, supra-structures, ceramic bonding with suitable ceramics

Norm: DIN EN ISO 22674, Type 4



Thickness	Border	REF	Quantity
8 mm	without	102-750-01	1 piece
10 mm	without	102-751-01	1 piece
12 mm	10 mm	102-752-01	1 piece
13.5 mm	10 mm	102-753-01	1 piece
15 mm	10 mm	102-754-01	1 piece
18 mm	10 mm	102-755-01	1 piece
20 mm	10 mm	102-756-01	1 piece
25 mm	10 mm	102-757-01	1 piece

CE 0483

Technical data

0.2% Yield strength $R_{p0.2}$	364 MPa
Tensile strength R_m	506 MPa
Hardness	281 HV 10
Elongation A_5	5.9 %
Modulus of elasticity E	202 GPa
Density	8.5 g/cm ³
CTE 25–500 °C / 77–932 °F	14.1 x 10 ⁻⁶ K ⁻¹
Solidus temperature	1320 °C / 2408 °F
Liquidus temperature	1420 °C / 2588 °F

Composition (percentage by mass)

Co	Cr	W	Si
60.5	28.0	9.0	1.5

Additional elements < 1 %: Fe, Mn, N, Nb

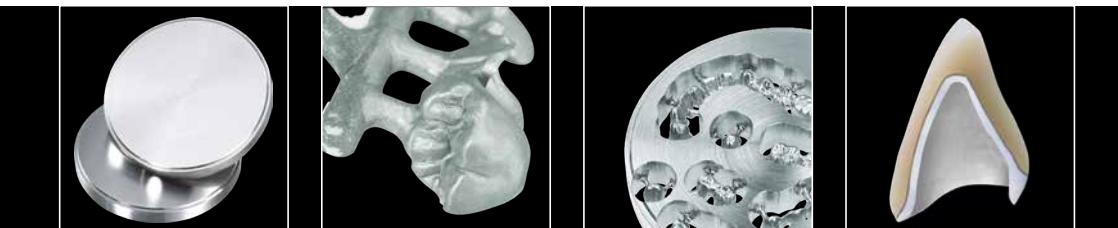

Titanium blanks



rematitan® blank Ti2

Titanium grade 2

Norm: DIN EN ISO 9693, DIN EN ISO 22674, ISO 5832-2

Pure titanium blank for all applications in crown and bridge work.

Highly biocompatible and gentle on the tools during milling.

Product advantages:

- High level of biocompatibility.
- Ideal for ceramic veneering using bonding ceramics suitable for titanium such as ceraMotion® Ti
- High degree of corrosion resistance
- Good milling properties due to low hardness

Indication: for all constructions manufactured using milling technique such as crowns, bridges, supra-structures, ceramic bonding with suitable ceramics

Thickness	Border	REF	Quantity
10 mm	without	100-202-10	1 piece
12 mm	10 mm	100-202-12	1 piece
15 mm	10 mm	100-202-15	1 piece
20 mm	10 mm	100-202-20	1 piece

CE⁰⁴⁸³

Technical data

0.2% Yield strength $R_{p0.2}$	360 MPa
Tensile strength R_m	505 MPa
Hardness	225 HV 10
Modulus of elasticity E	103 GPa
Density	4.5 g/cm ³
Melting point	1.665 °C
CTE 25–500 °C / 77–932 °F	9.6 x 10 ⁻⁶ K ⁻¹



NEW

rematitan® blank Ti5

Titanium grade 5

Norm: DIN EN ISO 9693, DIN EN ISO 22674, ISO 5832-3

Titanium alloy (Ti Al6 V4) with increased mechanical hardness. Particularly suitable for long-span, delicate framework structures and for implant work.

Product advantages:

- High mechanical strength
- High level of biocompatibility in implant quality
- Ideal for ceramic veneering using bonding ceramics suitable for titanium such as ceraMotion® Ti
- High degree of corrosion resistance

Indication: implant supported supra-structures, for all constructions manufactured using milling technique such as crowns, bridges, supra-structures, ceramic bonding with suitable ceramics



Thickness	Border	REF	Quantity
10 mm	without	100-205-10	1 piece
12 mm	10 mm	100-205-12	1 piece
15 mm	10 mm	100-205-15	1 piece
20 mm	10 mm	100-205-20	1 piece

CE 0483

Technical data

0.2% Yield strength $R_{p0.2}$	832 MPa
Tensile strength R_m	908 MPa
Hardness	285 HV 10
Modulus of elasticity E	105 GPa
Density	4.3 g/cm ³
CTE 25–500 °C / 77–932 °F	10.0 x 10 ⁻⁶ K ⁻¹

**NEW**

DENTAURUM
**ONLINE
SHOP**
shop.dentaurum.com



Wax blanks



StarWax Blank blue

ø 98.4 mm

StarWax Blank blue is ideal for CAD/Vest cast partial dentures to be cast.

Product advantages:

- Tension-free
- High fracture strength
- Accurate fit

Indication: wax-ups in crown and bridge technique, stabilizing of wax constructions

Thickness	Border	Color	REF	Quantity
25.0 mm	10 mm	blue	120-235-00	1 piece

Technical data

Dropping point	100-130 °C / 212-266 °F
Density	0.92-0.97 g/cm ³

NEW



StarWax Blank grey

ø 98.4 mm

StarWax Blank grey is ideal for CAD/Vest crowns and bridges to be pressed or cast.

Product advantages:

- Residue-free burnout
- High edge strength
- Slightly elastic

Indication: wax-ups in crown and bridge technique, stabilizing of wax constructions

Thickness	Border	Color	REF	Quantity
20.0 mm	10 mm	grey	120-230-00	1 piece

Technical data

Dropping point	100-130 °C / 212-266 °F
Density	0.92-0.97 g/cm ³

NEW

Nacera® Pearl Q³ Multi-Shade MS

ø 98.3 mm

Polychromatic, ultra-high translucent zirconium oxide.

Advantages & indication:

- Revolutionary match of the Vita* shades and lifelike smooth color transitions
- Make monolithic crowns and bridges up to 3 units, veneers, inlays, onlays
- Finish in one bake, e.g. with ceraMotion® One Touch
- Ergonomic system to achieve the most common shades
- Extremely high-precision fitting thanks to Instant Fit Process (I.F.P.)



Color	REF (16 mm)	REF (20 mm)	Quantity
MS-A-Light	270-060-16	270-060-20	1 piece
MS-A-Dark	270-070-16	270-070-20	1 piece
MS-B-Light	270-061-16	270-061-20	1 piece
MS-B-Dark	270-071-16	270-071-20	1 piece
MS-C-Light	270-062-16	270-062-20	1 piece
MS-C-Dark	270-072-16	270-072-20	1 piece

CE 0481

*Vita is a registered trademark of Vita Zahnfabrik H. Rauter GmbH & Co.KG, 79704 Bad Säckingen, Germany.

Hardness	1300 HV 0.5
Material	ZrO ₂ 3Y-TZP
Thermal conductivity	2 W/mK
4 point flexural strength	600 MPa
Density	> 6.04 g/cm ³
Radioactivity	< 0.02 Bq/g
Impact resistance	8 MPa m ^{1/2}
Medium grain size	< 0.4 µm
Solubility	< 10 µg/cm ²
CTE	10 x 10 ⁻⁶ K ⁻¹
Compression resistance	3000 MPa

NEW

Zirconium oxide blanks



Nacera® Pearl Multi-Shade MS

ø 98,3 mm

Nacera® Pearl Multi-Shade blanks in zirconium oxide.

Advantages & indications:

- highly translucent multi-layered system with a natural look
- natural and smooth shade transitions from cervical to incisal
- extremely efficient – one blank covers several shades
- quick and economical for natural-looking monolithic restorations
- excellent machinability without fracturing or chipping
- extremely high-precision fitting thanks to Instant Fit Process (I.F.P.)

NEW

Color	REF (14 mm)	REF (18 mm)	REF (22 mm)	Quantity
MS-A	270-050-14	270-050-18	270-050-22	1 piece
MS-B	270-051-14	270-051-18	270-051-22	1 piece
MS-C	270-052-14	270-052-18	270-052-22	1 piece
MS-D	270-053-14	270-053-18	270-053-22	1 piece
MS-A-Light	270-084-14	270-084-18	270-084-22	1 piece
MS-A-Dark	270-054-14	270-054-18	270-054-22	1 piece
MS-B-Light	270-085-14	270-085-18	270-085-22	1 piece
MS-B-Dark	270-055-14	270-055-18	270-055-22	1 piece
MS-C-Light	270-086-14	270-086-18	270-086-22	1 piece
MS-C-Dark	270-056-14	270-056-18	270-056-22	1 piece
MS-D-Light	270-087-14	270-087-18	270-087-22	1 piece
MS-D-Dark	270-057-14	270-057-18	270-057-22	1 piece

CE⁰⁴⁸¹

Technical data

Hardness	1300 HV 0.5
Material	ZrO ₂ 3Y-TZP
Thermal conductivity	2 W/mK
4 point flexural strength	1200 MPa
Density	> 6.04 g/cm ³
Radioactivity	< 0.02 Bq/g
Impact resistance	8 MPa m ^{1/2}
Medium grain size	< 0.4 µm
Solubility	< 10 µg/cm ²
CTE	10 x 10 ⁻⁶ K ⁻¹
Compression resistance	3000 MPa

Nacera® Pearl Shaded 16+2

ø 98.3 mm

Colored, highly translucent zirconium oxide in 16 V-Classic colors and two bleach colors.

Advantages & indications:

- for multiple indications – highly stable while highly translucent, meeting all demands
- shade and process stability thanks to homogeneous coloring, ensuring consistent color results
- economic solution, as the dipping process and the use of coloring liquids are no longer necessary
- excellent machinability without fracturing or chipping
- delivers flawless monolithic restorations with a natural aesthetic
- extremely high-precision fitting thanks to Instant Fit Process (I.F.P.)



Color	REF (12 mm)	REF (14 mm)	REF (16 mm)	REF (18 mm)	REF (20 mm)	REF (25 mm)	Quantity
OM2	270-009-12	270-009-14	270-009-16	270-009-18	270-009-20	270-009-25	1 piece
OM3	270-010-12	270-010-14	270-010-16	270-010-18	270-010-20	270-010-25	1 piece
A1	270-011-12	270-011-14	270-011-16	270-011-18	270-011-20	270-011-25	1 piece
A2	270-012-12	270-012-14	270-012-16	270-012-18	270-012-20	270-012-25	1 piece
A3	270-013-12	270-013-14	270-013-16	270-013-18	270-013-20	270-013-25	1 piece
A3,5	270-014-12	270-014-14	270-014-16	270-014-18	270-014-20	270-014-25	1 piece
A4	270-015-12	270-015-14	270-015-16	270-015-18	270-015-20	270-015-25	1 piece
B1	270-021-12	270-021-14	270-021-16	270-021-18	270-021-20	270-021-25	1 piece
B2	270-022-12	270-022-14	270-022-16	270-022-18	270-022-20	270-022-25	1 piece
B3	270-023-12	270-023-14	270-023-16	270-023-18	270-023-20	270-023-25	1 piece
B4	270-024-12	270-024-14	270-024-16	270-024-18	270-024-20	270-024-25	1 piece
C1	270-031-12	270-031-14	270-031-16	270-031-18	270-031-20	270-031-25	1 piece
C2	270-032-12	270-032-14	270-032-16	270-032-18	270-032-20	270-032-25	1 piece
C3	270-033-12	270-033-14	270-033-16	270-033-18	270-033-20	270-033-25	1 piece
C4	270-034-12	270-034-14	270-034-16	270-034-18	270-034-20	270-034-25	1 piece
D2	270-042-12	270-042-14	270-042-16	270-042-18	270-042-20	270-042-25	1 piece
D3	270-043-12	270-043-14	270-043-16	270-043-18	270-043-20	270-043-25	1 piece
D4	270-044-12	270-044-14	270-044-16	270-044-18	270-044-20	270-044-25	1 piece

CE 0481

Technical data

Hardness	1300 HV 0.5
Material	ZrO ₂ 3Y-TZP
Thermal conductivity	2 W/mK
4 point flexural strength	1200 MPa
Density	> 6.04 g/cm ³
Radioactivity	< 0.02 Bq/g
Impact resistance	8 MPa m ^{1/2}
Medium grain size	< 0.4 µm
Solubility	< 10 µg/cm ²
CTE	10 x 10 ⁻⁶ K ⁻¹
Compression resistance	3000 MPa

Zirconium oxide blanks



Nacera® Pearl white

ø 98.3 mm

White, highly translucent zirconium oxide.

Advantages and indications:

- for multiple indications – from veneers to wide span bridges supported by implants
- highly translucent and extremely stable: flexural strength 1400 MPa, hardness 1300 HV
- natural translucency for aesthetic monolithic restorations
- flexible sintering temperature 1450 °C - 1550 °C / 2642 °F - 2822 °F
- extremely high-precision fitting thanks to Instant Fit Process (I.F.P.)

Also available in semi-translucent (Nacera® Shell white).

Thickness	Color	REF	Quantity
10 mm	White, highly translucent	270-001-10	1 piece
12 mm	White, highly translucent	270-001-12	1 piece
14 mm	White, highly translucent	270-001-14	1 piece
16 mm	White, highly translucent	270-001-16	1 piece
18 mm	White, highly translucent	270-001-18	1 piece
20 mm	White, highly translucent	270-001-20	1 piece
25 mm	White, highly translucent	270-001-25	1 piece

CE 0481

Technical data

Hardness	1300 HV 0.5
Material	ZrO ₂ 3Y-TZP
Thermal conductivity	2 W/mK
4 point flexural strength	1200 MPa
Density	> 6.04 g/cm ³
Radioactivity	< 0.02 Bq/g
Impact resistance	8 MPa m ^{1/2}
Medium grain size	< 0.4 µm
Solubility	< 10 µg/cm ²
CTE	10 x 10 ⁻⁶ K ⁻¹
Compression resistance	3000 MPa

Nacera® Shell white

ø 98.3 mm

White, semi-translucent zirconium oxide.

Advantages and indications:

- excellent cover of discolored stumps and metal abutments
 - extremely high-precision fitting thanks to Instant Fit Process (I.F.P.)
- Also available in highly translucent (Nacera® Pearl white).



Thickness	Color	REF	Quantity
10 mm	White, opaque	270-002-10	1 piece
12 mm	White, opaque	270-002-12	1 piece
14 mm	White, opaque	270-002-14	1 piece
16 mm	White, opaque	270-002-16	1 piece
18 mm	White, opaque	270-002-18	1 piece
20 mm	White, opaque	270-002-20	1 piece
25 mm	White, opaque	270-002-25	1 piece

CE 0481

Technical data

Hardness	1300 HV 0.5
Material	ZrO ₂ 3Y-TZP
Thermal conductivity	2 W/mK
4 point flexural strength	1200 MPa
Density	> 6.04 g/cm ³
Radioactivity	< 0.02 Bq/g
Impact resistance	8 MPa m ^{1/2}
Medium grain size	< 0.4 µm
Solubility	< 10 µg/cm ²
CTE	10 x 10 ⁻⁶ K ⁻¹
Compression resistance	3000 MPa

Zirconium oxide / Coloring liquids



Nacera® Classic Liquids Set

Coloring liquids for perfect, natural results.
Set with 16 body colors and 8 different shade modifiers
incl. chronometer, funnel, tweezers and brush.

REF 271-100-00	1 set
CE 0481	Contents:
1 x CL Body A1	REF 271-011-50
1 x CL Body A2	REF 271-012-50
1 x CL Body A3	REF 271-013-50
1 x CL Body A 3.5	REF 271-014-50
1 x CL Body A4	REF 271-015-50
1 x CL Body B1	REF 271-021-50
1 x CL Body B2	REF 271-022-50
1 x CL Body B3	REF 271-023-50
1 x CL Body B4	REF 271-024-50
1 x CL Body C1	REF 271-031-50
1 x CL Body C2	REF 271-032-50
1 x CL Body C3	REF 271-033-50
1 x CL Body C4	REF 271-034-50
1 x CL Body D2	REF 271-042-50
1 x CL Body D3	REF 271-043-50
1 x CL Body D4	REF 271-044-50
1 x CL Body Diluting	REF 271-050-50
1 x CL Enamel I	REF 271-051-20
1 x CL Enamel II	REF 271-052-20
1 x CL Effect Blue	REF 271-061-20
1 x CL Effect Brown	REF 271-071-20
1 x CL Effect Grey	REF 271-065-20
1 x CL Effect Orange	REF 271-075-20
1 x CL Balancer	REF 271-074-20
1 x Chrono	REF 271-105-00
1 x Tweezer	REF 271-107-00
1 x Funnel	REF 271-104-00
1 x Brush I, Kolinsky-M	REF 271-101-00

Nacera® Classic Liquids

Nacera® Classic Liquids can either be applied directly using a brush, or by dipping. A combination of the two is also possible using shade modifiers in the incisal area. It is also possible to individualize pre-dyed zirconium oxide.

Nacera® Classic Liquids were developed especially for Nacera® Pearl zirconium oxide in order to achieve maximum shading reliability, highest aesthetics and efficiency.



Abbreviation	REF	Quantity	REF	Quantity
CL Body A1	271-011-50	50 ml		
CL Body A2	271-012-50	50 ml		
CL Body A3	271-013-50	50 ml		
CL Body A3,5	271-014-50	50 ml		
CL Body A4	271-015-50	50 ml		
CL Body B1	271-021-50	50 ml		
CL Body B2	271-022-50	50 ml		
CL Body B3	271-023-50	50 ml		
CL Body B4	271-024-50	50 ml		
CL Body C1	271-031-50	50 ml		
CL Body C2	271-032-50	50 ml		
CL Body C3	271-033-50	50 ml		
CL Body C4	271-034-50	50 ml		
CL Body D2	271-042-50	50 ml		
CL Body D3	271-043-50	50 ml		
CL Body D4	271-044-50	50 ml		
CL Body Diluting	271-050-50	50 ml		
CL Enamel I			271-051-20	20 ml
CL Enamel II			271-052-20	20 ml
CL Effect Blue			271-061-20	20 ml
CL Effect Grey			271-065-20	20 ml
CL Effect Brown			271-071-20	20 ml
CL Effect Orange			271-075-20	20 ml
CL Balancer			271-074-20	20 ml

CE 0481



Zirconium oxide / Coloring liquids



Brush I, Kolinsky-M

Brush for the application of Nacera® Classic Liquids.

REF 271-101-00

1 piece



Brush II, Kolinsky-S

Brush for the application of Nacera® Classic Liquids.

REF 271-102-00

1 piece



Nacera® Pipette

Accessory for Nacera® Classic Liquids.

REF 271-103-00

1 piece



Nacera® Funnel

Accessory for Nacera® Classic Liquids.

REF 271-104-00

1 piece



Nacera® Chrono

Chronometer as accessory for Nacera® Classic Liquids.

REF 271-105-00

1 piece



Nacera® Blue X set

Fluid to increase translucency.

- Individual. Increase translucency – at selected points
- Flexible. Anterior areas, incisal edges – wherever it is requested
- Efficient. No need for additional UHT zirconium blanks.

Indication: anterior and posterior region, bridges up to three units

REF 271-090-00

1 set

CE 0481

Zirconium oxide – accessories

Nacera® Clean powder starter kit

REF 271-120-00

1 x 200 g

Advantages:

- No more yellow or green discoloration of the sintered objects
- No particles on the zirconium oxide surface
- Absorbs coloring liquid sediments from the furnace chamber
- Ensures reliable, translucent results



Nacera® Clean powder bundle

REF 271-122-00

1 set

Advantages:

- No more yellow or green discoloration of the sintered objects
- No particles on the zirconium oxide surface
- Absorbs coloring liquid sediments from the furnace chamber
- Ensures reliable, translucent results

Set = 1 x 200 g, 4 x 30 g



Nacera® Calibrate

Measuring equipment for the calibration of sintering and ceramic furnaces. Set with 15 calibration rings, reference ring and dial gauge.

REF 271-135-00

1 set

NEW



Nacera® Calibration rings for sintering furnaces

Calibration rings for sintering furnace.

REF 271-136-15

15 pieces

NEW



Zirconium oxide – accessories



Nacera® Shine Zr

Nacera® Shine Zr is a diamond polishing paste to quickly achieve a long-lasting high-quality shine on zirconium oxide.

- high gloss finish of the fully-ceramic restoration in 90 seconds
- long-lasting high-quality shine on zirconium oxide
- very high diamond content and an exceptionally hard consistency – for less work and lower costs
- easy to handle and efficient in terms of consumption
- effective and time-saving to use

Indication: for shiny ceramic surfaces

REF 271-130-14

14 g

NEW



Nacera® Shine Zr Special Edition

Nacera® Shine Zr is a diamond polishing paste to quickly achieve a long-lasting high-quality shine on zirconium oxide.

- high gloss finish of the fully-ceramic restoration in 90 seconds
- long-lasting high-quality shine on zirconium oxide
- very high diamond content and an exceptionally hard consistency – for less work and lower costs
- easy to handle and efficient in terms of consumption
- effective and time-saving to use

Indication: for shiny ceramic surfaces

REF 271-131-14

14 g

NEW

CoCr alloys	Page	156
NiCr alloys	Page	163
Titanium	Page	166
Solders and welding wires	Page	168
Attachments and accessories	Page	172
Investment materials	Page	173
Waxes	Page	181
Investment systems	Page	185
Modelling accessories	Page	187
Accessories	Page	188



Crowns and bridges.

A wide spectrum for high-quality dental restorations.



DENTAURUM
**ONLINE
SHOP**
shop.dentaurum.com





Biocompatible dental restorations.

In addition to the tried-and-trusted remanium® alloys for conventional and digital solutions, there is an increase in the use of ceramic materials for frames and monolithic restorations.

Wide range of products.

The ceraMotion® ceramic products offer press ceramics for all-ceramic structures as well as veneering ceramics. Zirconium oxide (Nacera®*) is processed with ceraMotion® ceramics and 3D stains to produce highly aesthetic restorations. Metal materials for the frame such as CoCr or titanium remain a core element for the manufacture of frames.



Photo © Rainer Semsch

* Nacera® is a registered trademark of Doceram Medical GmbH, Germany.

remanium® C+B alloys

Non-precious and corrosion resistant.

C+B investment materials

For all types of alloys.

C+B modelling waxes

For all types of applications.

C+B accessories

Accessories for crown and bridgework.

remanium®
star 



One alloy.

The successful remanium® star formula.

60.5 % Co | 28.0 % Cr | 9.0 % W | 1.5 % Si

Dentaurum's non-precious remanium® casting alloys have been a synonym for quality in prosthetics for decades and millions are in use. In order to offer all users of new technologies the possibility to keep processing our well-proven and clinically-tested alloys, our CoCr alloy remanium® star is available in the same quality for three processing technologies.

Three processing technologies.

We guarantee the premium quality of remanium® in all three processing technologies.

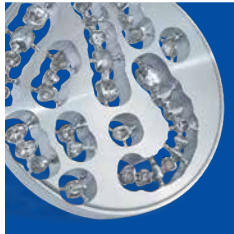
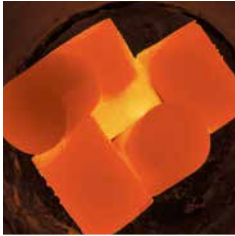

Casting.

- Excellent melting and flow behavior.
- Correct casting moment visible in high-frequency melting.
- Extremely easy to work with, especially when milling or polishing, due to reduced hardness.

Milling.

- Two premium qualities: powder metallurgical or optimized casting structure.
- Excellent strength.
- Low hardness allows easy milling.

Laser melting.

- Finest powder for homogeneous structure.
- Dense structure.
- Constant material characteristics.

remanium®

C+B alloys: Clinically proven millions of times.

Quality and purity – made in Germany.

The successful remanium® formula.

- Development, manufacture and inspection at Dentaureum in Ispringen, Germany.
- Only raw materials of purest quality are used with all remanium® alloys.
- Maximum corrosion resistance and scientifically-proven biocompatibility.
- Excellent bonding strength with veneering ceramics (e.g. ceraMotion® Me).
- Our wealth of experience guarantees absolute reliability and very easy processing.



*The application for the trademark registration of remanium® was filed 30 years after the market launch of the non-precious alloy remanit.

remanium® NiCr alloys at a glance.

	remanium® CS+	remanium® CSe	remanium® G-soft																												
Characteristics	NiCr bonding alloy type 3 with outstanding ceramic bond. Square ingots for quick, reliable casting.	NiCr bonding alloy type 3 with very user-friendly processing properties.	Proven NiCr alloy type 3 for crown and bridge work and composite veneering.																												
Product advantages	<ul style="list-style-type: none"> ■ excellent ceramic bond – also with several firing cycles ■ no long-term cooling of the ceramic required ■ beryllium-free, biocompatible ■ excellent melting and casting characteristics ■ maximum corrosion resistance 	<ul style="list-style-type: none"> ■ very easy processing due to considerably reduced hardness ■ no long-term cooling of the ceramic required ■ beryllium-free, biocompatible ■ quick, easy melting 	<ul style="list-style-type: none"> ■ excellent melting and casting characteristics ■ easy polishing and high lustre ■ high corrosion resistance ■ high strength for delicate frames ■ ideal for melting with a flame 																												
Composition (by mass)	<table border="1"> <tr><td>Ni</td><td>Cr</td><td>Mo</td><td>Si</td><td>Fe</td></tr> <tr><td>61.0</td><td>26.0</td><td>11.0</td><td>1.5</td><td>1.2</td></tr> </table>	Ni	Cr	Mo	Si	Fe	61.0	26.0	11.0	1.5	1.2	<table border="1"> <tr><td>Ni</td><td>Cr</td><td>Mo</td><td>Si</td><td>Fe</td></tr> <tr><td>61.0</td><td>26.0</td><td>11.0</td><td>1.5</td><td>1.2</td></tr> </table>	Ni	Cr	Mo	Si	Fe	61.0	26.0	11.0	1.5	1.2	<table border="1"> <tr><td>Ni</td><td>Cr</td><td>Mo</td><td>Si</td></tr> <tr><td>66.0</td><td>26.5</td><td>5.0</td><td>1.5</td></tr> </table>	Ni	Cr	Mo	Si	66.0	26.5	5.0	1.5
Ni	Cr	Mo	Si	Fe																											
61.0	26.0	11.0	1.5	1.2																											
Ni	Cr	Mo	Si	Fe																											
61.0	26.0	11.0	1.5	1.2																											
Ni	Cr	Mo	Si																												
66.0	26.5	5.0	1.5																												
Other < 1%	Co	Co	Mn, B																												
Summary relevant characteristics																															
Oxide firing	no	no	no																												
Soldering with NiCr solder	REF 102-302-00	REF 102-302-00	REF 102-302-00																												
Laser welding	+++ NiCr welding wire REF 528-220-00	+++ NiCr welding wire REF 528-220-00	+++ NiCr welding wire REF 528-220-00																												
Investment material	Trivest, Castorit® all speed, Castorit®-super C, rema® CC	Trivest, Castorit® all speed, Castorit®-super C, rema® CC	Trivest, Castorit® all speed, Castorit®-super C, rema® CC																												
Mechanical properties																															
0.2% yield strength R _{p0.2}	340 MPa	340 MPa	400 MPa																												
Tensile strength R _m	580 MPa	580 MPa	700 MPa																												
Modulus of elasticity E	170 GPa	170 GPa	165 GPa																												
Hardness	195 HV 10	195 HV 10	210 HV 10																												
Elongation A ₅	15 %	15 %	10 %																												
Solidus temperature	1260 °C / 2300 °F	1260 °C / 2300 °F	1210 °C / 2210 °F																												
Liquidus temperature	1350 °C / 2462 °F	1350 °C / 2462 °F	1240 °C / 2264 °F																												
Density	8.2 g/cm ³	8.2 g/cm ³	8.2 g/cm ³																												
CTE 25–500 °C / 77 – 932 °F	14 x 10 ⁻⁶ K ⁻¹	14 x 10 ⁻⁶ K ⁻¹	–																												
Ordering information																															
Availability	50 g REF 102-401-00 250 g REF 102-402-00 1.000 g REF 102-403-00	50 g REF 102-401-05 1000 g REF 102-403-05	1000 g REF 100-001-00																												
Safety through certified quality  ⁰⁴⁸³																															

Best biocompatibility: Laboratory tests confirm the outstanding corrosion resistance, and tests conducted by independent institutes acknowledge the biological compatibility on the basis of cytotoxicity tests. Please inquire for our certifications. All NiCr crown and bridge alloys are free of beryllium, gallium, indium and copper.

+++ = excellent – = not suitable

remanium® CoCr alloys at a glance.

	remanium® star	remanium® secura																					
Characteristics	Modern bonding alloy type 5 with excellent processing characteristics and low hardness. Suitable for all processing technologies.	CoCr bonding alloy type 5 with maximum reliability potential during processing. Excellent casting behavior, also for vacuum/pressure casting.																					
Product advantages	<ul style="list-style-type: none"> extremely easy to work with, especially when milling or polishing due to the reduced hardness suitable for processing technologies such as casting, milling and laser melting excellent veneerability because of the low thermal expansion coefficient oxide firing is not necessary long-term cooling is only recommended with long-span bridges particularly recommended for telescopic work suitable for laser welding since carbon-free 	<ul style="list-style-type: none"> reliable melting and casting characteristics, especially with vacuum/pressure casting, resulting from the narrow melting range small ingots (4 g) allow exact portioning of the alloy: ideal and economical filling of the crucible no danger of spattering or increased slagging high mechanical strength thanks to tantalum mixed-crystal reinforcement optimized bake behavior of the veneering ceramic through low oxidation 																					
Composition (% by mass)	<table border="1"> <thead> <tr> <th>Co</th> <th>Cr</th> <th>W</th> <th>Si</th> </tr> </thead> <tbody> <tr> <td>60.5</td> <td>28.0</td> <td>9.0</td> <td>1.5</td> </tr> </tbody> </table>	Co	Cr	W	Si	60.5	28.0	9.0	1.5	<table border="1"> <thead> <tr> <th>Co</th> <th>Cr</th> <th>W</th> <th>Mo</th> <th>Si</th> <th>Ta</th> </tr> </thead> <tbody> <tr> <td>58.0</td> <td>30.0</td> <td>5.5</td> <td>3.0</td> <td>1.5</td> <td>1.25</td> </tr> </tbody> </table>	Co	Cr	W	Mo	Si	Ta	58.0	30.0	5.5	3.0	1.5	1.25	
Co	Cr	W	Si																				
60.5	28.0	9.0	1.5																				
Co	Cr	W	Mo	Si	Ta																		
58.0	30.0	5.5	3.0	1.5	1.25																		
Other < 1%	Mn, N, Nb	N																					

Summary relevant characteristics

Oxide firing	no	no
Soldering with CoCr solder	REF 102-306-00	REF 102-306-00
Laser welding	+++	+++
Investment material	Trivest, Castorit® all speed, Castorit®-super C, rema® TT, rema® CC	Trivest, Castorit® all speed, Castorit®-super C, rema® TT, rema® CC

Mechanical properties

0.2 % yield strength (R _{p0.2})	620 MPa	760 MPa
Tensile strength R _m	845 MPa	940 MPa
Modulus of elasticity E	190 GPa	211 GPa
Hardness	280 HV 10	340 HV 10
Elongation A ₅	10.2 %	5.3 %
Solidus temperature	1320 °C / 2408 °F	1329 °C / 2424 °F
Liquidus temperature	1420 °C / 2588 °F	1385 °C / 2525 °F
Density	8.6 g/cm ³	8.6 g/cm ³
CTE 25–500 °C / 77-932 °F	14.1 x 10 ⁻⁶ K ⁻¹	14.4 x 10 ⁻⁶ K ⁻¹

Ordering information

Availability	50 g	REF 102-621-00	50 g	REF 102-631-00
	250 g	REF 102-622-00	250 g	REF 102-632-00
	1000 g	REF 102-620-00	1000 g	REF 102-630-00

Safety through certified quality 0483

Best biocompatibility: Laboratory tests confirm the outstanding corrosion resistance, and tests conducted by independent institutes acknowledge the biological compatibility on the basis of cytotoxicity tests. Please inquire for our certifications. All CoCr crown and bridge alloys are free of beryllium, iron (except remanium® LFC), nickel, gallium, indium and copper.

	remanium® 2000+	remanium® 2001	remanium® LFC																														
Characteristics	Clinically time-tested CoCr bonding alloy type 5 with low CTE value.	CoCr bonding alloy type 5. Easy processing characteristics.	CoCr bonding alloy type 5 with a high CTE value for low-fusing, high-expansion veneering ceramics.																														
Product advantages	<ul style="list-style-type: none"> ■ exceptionally free-flowing ■ flexibility in casting: can be melted in a high frequency induction casting unit, or with the propane/oxygen torch (no spattering) ■ oxide firing is not necessary ■ suitable for laser welding since carbon-free 	<ul style="list-style-type: none"> ■ exceptionally free-flowing ■ flexibility in casting: can be melted in a high frequency induction casting unit, or with the propane/oxygen torch (no spattering) ■ increased efficiency: oxide firing is not necessary ■ suitable for laser welding since carbon-free 	<ul style="list-style-type: none"> ■ specially for metal ceramics with low-fusing veneering ceramics (LFC¹), which have a matched CTE ■ excellent melting and casting behavior with all melting and casting techniques ■ effortless trimming and polishing ■ free from nickel and beryllium ■ high mechanical strength 																														
Composition (% by mass)	<table border="1"> <thead> <tr> <th>Co</th> <th>Cr</th> <th>Mo</th> <th>W</th> <th>Si</th> </tr> </thead> <tbody> <tr> <td>63.0</td> <td>23.0</td> <td>7.0</td> <td>5.0</td> <td>1.5</td> </tr> </tbody> </table>	Co	Cr	Mo	W	Si	63.0	23.0	7.0	5.0	1.5	<table border="1"> <thead> <tr> <th>Co</th> <th>Cr</th> <th>Mo</th> <th>W</th> <th>Si</th> </tr> </thead> <tbody> <tr> <td>63.0</td> <td>23.0</td> <td>7.3</td> <td>4.3</td> <td>1.6</td> </tr> </tbody> </table>	Co	Cr	Mo	W	Si	63.0	23.0	7.3	4.3	1.6	<table border="1"> <thead> <tr> <th>Co</th> <th>Cr</th> <th>Fe</th> <th>Mo</th> <th>Mn</th> </tr> </thead> <tbody> <tr> <td>33.0</td> <td>30.0</td> <td>29.0</td> <td>5.0</td> <td>1.5</td> </tr> </tbody> </table>	Co	Cr	Fe	Mo	Mn	33.0	30.0	29.0	5.0	1.5
Co	Cr	Mo	W	Si																													
63.0	23.0	7.0	5.0	1.5																													
Co	Cr	Mo	W	Si																													
63.0	23.0	7.3	4.3	1.6																													
Co	Cr	Fe	Mo	Mn																													
33.0	30.0	29.0	5.0	1.5																													
Other < 1%	Mn, N	Mn, N	Si, N, C																														

Summary relevant characteristics

Oxide firing	no	no	no
Soldering with CoCr solder	REF 102-306-00	REF 102-306-00	REF 102-306-00
Laser welding	+++	+++	+++
Investment material	Trivest, Castorit® all speed, Castorit®-super C, rema® TT, rema® CC	Trivest, Castorit® all speed, Castorit®-super C, rema® TT, rema® CC	Trivest, Castorit® all speed, Castorit®-super C, rema® TT, rema® CC

Mechanical properties

0.2 % yield strength (R _{p0.2})	700 MPa	660 MPa	660 MPa
Tensile strength R _m	900 MPa	850 MPa	950 MPa
Modulus of elasticity E	200 GPa	195 GPa	200 GPa
Hardness	340 HV 10	336 HV 10	315 HV 10
Elongation A ₅	7 %	3.5 %	11 %
Solidus temperature	1290 °C / 2354 °F	1325 °C / 2417 °F	1280 °C / 2336 °F
Liquidus temperature	1415 °C / 2579 °F	1415 °C / 2579 °F	1350 °C / 2462 °F
Density	8.6 g/cm ³	8.6 g/cm ³	8.2 g/cm ³
CTE 25–500 °C / 77-932 °F	14 x 10 ⁻⁶ K ⁻¹	14.2 x 10 ⁻⁶ K ⁻¹	15.9 x 10 ⁻⁶ K ⁻¹

Ordering information

Availability	50 g REF 102-601-10 250 g REF 102-602-10 1000 g REF 102-600-10	50 g REF 102-600-02 1000 g REF 102-600-01	250 g REF 102-642-00 1000 g REF 102-640-00
---------------------	--	--	---

Safety through certified quality 0483

+++ = excellent ++ = very good

¹ LFC = Low Fusing Ceramics

C+B investment materials.

Accurate in precision and handling.

Largest range of investment materials.

Dentaurum covers a large range of investment material. Whether for cast partial dentures or crown and bridge techniques, whether for the conventional method or for speed preheating, whether for precious metal alloys, non-precious metal alloys or titanium, Dentaurum, as one of the world's largest manufacturer of investment materials, can offer the right investment for each individual technique.

Batch consistency due to strict controls and final check.

Prior to filling into the proportioned aluminum foil bags, the quality of the investment material is examined according to dental technical standards as well as DIN and ISO norms.

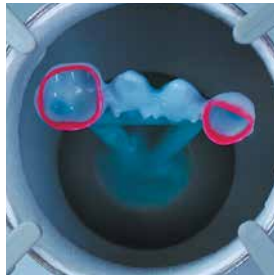

rema[®]
cc 

Universal crown and bridge investment for all indications, alloys and press ceramics.

rema[®]
TT 

Special investment material for telescopic crowns made from non-precious alloys.

**Castorit[®]-
all speed**

High-expansion, individually controllable speed investment material for all alloys (except titanium).

**Castorit[®]-
super C**

The "classic" for all non-precious alloys.

Trivest

The crown and bridge investment for non-precious alloys. Excellent control of expansion.

cera[®]motion[®]
press invest

Special investment material for press ceramics. Extremely smooth and dense surfaces, especially when used with lithium disilicate.

Crown and bridge investment materials at a glance.

	rema [®] CC	rema [®] TT	
Characteristics	Universal speed investment for all indications, alloys and press ceramics.	High expansion, special investment material for telescope crowns in non-precious alloys.	
Product advantages	<ul style="list-style-type: none"> ■ a single investment for all applications ■ maximum stability with all preheating techniques ■ precisely targeted expansion control for precious metal alloys, non-precious metal alloys and press ceramics ■ free choice of investment systems (metal ring or ring-free) ■ high accuracy even with long-span bridges 	<ul style="list-style-type: none"> ■ precisely matched to the requirements of telescopic work in combination with non-precious metal alloys ■ accurate expansion control for producing the correct fit and friction ■ very good overall expansion ■ high stability with all sizes of casting rings and preheating techniques ■ high surface smoothness 	
Inlays, onlays (precious metal)	+++	-	
Crowns and bridges	+++	+	
Implant superstructures	+++	+	
Attachment work	+++	+++	
Summary relevant characteristics			
Preheating	<ul style="list-style-type: none"> ■ Speed preheating ■ Consistent preheating ■ Preheating with holding time 	<ul style="list-style-type: none"> ■ Speed preheating ■ Consistent preheating ■ Preheating with holding time 	
Mixing consistency	+++	+++	
Working time	+++	++	
Deflasking behavior	+++	++	
Ordering information			
Powder	REF 105-840-00 6 kg (60 x 100 g) REF 105-841-00 6 kg (38 x 160 g)	REF 106-740-00 4 kg (25 x 160 g)	
Mixing liquid	REF 105-845-00 1 l (Standard) REF 105-846-00 1 l (High expansion fluid)	REF 106-707-00 1 l (Standard)	

+++ = very good suitability ++ = good suitability + = limited suitability - = not suitable

	Castorit® all speed	Castorit®-super C	Trivest
Characteristics	High-expansion, individually controllable speed investment material for all alloys (except titanium).	Well-proven, user-friendly precision investment material for CoCr and NiCr alloys.	High-expansion, individually controllable investment material for non-precious metal alloys (except titanium).
Product advantages	<ul style="list-style-type: none"> ■ place into furnace for speed preheating at a final temperature of 950 °C/1742 °F or in stages overnight ■ its high expansion ensures a highly accurate fit ■ long working times and very creamy mixing consistency ■ extremely smooth casting surfaces for a uniform casting quality 	<ul style="list-style-type: none"> ■ high thermal stability and robustness ■ consistent highly accurate fit ■ easy devesting properties ■ creamy mixing consistency 	<ul style="list-style-type: none"> ■ very good control of expansion ■ very good overall expansion ■ easy devesting and sandblasting behavior ■ long working time
Inlays, onlays (precious metal)	++	-	-
Crowns and bridges	+++	+++	+++
Implant superstructures	+++	++	+++
Attachment work	+++	++	+++
Summary relevant characteristics			
Preheating	<ul style="list-style-type: none"> ■ Speed preheating ■ Consistent preheating ■ Preheating with holding time 	<ul style="list-style-type: none"> ■ Consistent preheating ■ Preheating with holding time 	<ul style="list-style-type: none"> ■ Consistent preheating ■ Preheating with holding time
Mixing consistency	+++	++	++
Working time	+++	++	++
Deflasking behavior	++	+++	+++
Ordering information			
Powder	REF 105-741-00 6 kg (40 x 150 g) REF 105-742-80 20 kg (8 x 2.5 kg)	REF 106-721-00 6 kg (40 x 150 g)	REF 106-731-00 6 kg (40 x 150 g)
Mixing liquid	REF 105-745-00 1 l (Standard)	REF 106-704-00 1 l (Standard) REF 105-502-00 1 l (Power Liquid)	REF 106-706-00 1 l (Standard) REF 105-502-00 1 l (Power Liquid)

CoCr alloys



remanium® star

Modern bonding alloy with excellent processing properties and low hardness. Suitable for all processing technologies.

Advantages:

- extremely easy to work with, especially when milling or polishing due to the exceptionally reduced hardness
- for all processing technologies such as casting, milling and laser melting
- excellent melting and flow behavior
- excellent ceramic fusion because of the low coefficient of thermal expansion
- no oxide firing required
- long time cooling is only recommended for long-span bridges
- particularly recommended for telescopic work
- suitable for laser welding because it is carbon free
- flexibility in casting: can be melt in a high frequency induction casting unit, or with the propane/oxygen torch
- increased efficiency

Indication: crowns and bridges, metal ceramics, double crowns, implant supported supra-structures, Maryland bridges, secondary parts for cast partial dentures (combination works)

Norm: DIN EN ISO 9693, DIN EN ISO 22674

Technical data

0.2% Yield strength $R_{p0.2}$	620 MPa
Tensile strength R_m	845 MPa
Hardness	280 HV 10
Elongation A_5	10.2 %
Modulus of elasticity E	190 GPa
Density	8.6 g/cm ³
CTE 25–500 °C / 77–932 °F	14.1 x 10 ⁻⁶ K ⁻¹
Solidus temperature	1320 °C / 2408 °F
Liquidus temperature	1420 °C / 2588 °F
Weight of casting ingot	6 g

REF 102-621-00	50 g
REF 102-622-00	250 g
REF 102-620-00	1000 g

CE 0483

Composition (percentage by mass)

Co	Cr	W	Si
60.5	28.0	9.0	1.5

Additional elements < 1 %: Mn, N, Nb

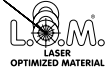

remanium® star MD I milling blank

∅ 98.4 mm

Proven high-tech CoCr bonding alloy for CAD/CAM milling systems.

Powder metallurgical manufacture with extremely homogeneous structure.

Advantages:

- proven remanium® star composition
- certified and time-tested base material for all applications in crown and bridge work
- hot isostatically compressed, 100 % free of porosity and contraction cavities
- fine-grained microstructure of the milling discs
- homogeneous structure of the material facilitates uniform, easy machinability on the respective milling machine
- maximum strength Type 5, DIN EN ISO 22674
- ideal for ceramic veneering using the conventional CTE range
- excellent laser weldability

Indication: for all constructions manufactured using milling technique such as crowns, bridges, supra-structures, ceramic bonding with suitable ceramics

Norm: DIN EN ISO 9693, DIN EN ISO 22674



Thickness	Border	REF	Quantity
8 mm	without	102-650-00	1 piece
10 mm	without	102-651-00	1 piece
12 mm	10 mm	102-652-00	1 piece
13.5 mm	10 mm	102-653-00	1 piece
15 mm	10 mm	102-654-00	1 piece

CE 0483

Special sizes for remanium® star MD I:

Special sizes with a thickness of up to 25 mm and a minimum purchase quantity of 50 blanks are available on request.

Please note the extended delivery time: 8–10 weeks.

remanium® star is also processed as SLM powder for the laser-melting technique by leading suppliers.
Information is available on request!

Technical data

0.2% Yield strength $R_{p0.2}$	635 MPa
Tensile strength R_m	1120 MPa
Hardness	330 HV 10
Elongation A_5	10.2 %
Modulus of elasticity E	230 GPa
Density	8.6 g/cm ³
CTE 25–500 °C / 77–932 °F	14.1 x 10 ⁻⁶ K ⁻¹
Solidus temperature	1320 °C / 2408 °F
Liquidus temperature	1420 °C / 2588 °F

Composition (percentage by mass)

Co	Cr	W	Si
60.5	28.0	9.0	1.5

Additional elements < 1 %: Fe, Mn, N, Nb



CoCr alloys



remanium® star MD II milling blank

ø 98.4 mm

Proven CoCr bonding alloy for CAD/CAM milling systems. Optimized casting structure in implant quality.

Advantages:

- proven remanium® star composition
- certified and time-tested base material for all applications in crown and bridge work
- very high ductility
- very high strength Type 4, DIN EN ISO 22674
- ideal for ceramic veneering using the conventional CTE range
- excellent laser weldability

Indication: for all constructions manufactured using milling technique such as crowns, bridges, supra-structures, ceramic bonding with suitable ceramics

Norm: DIN EN ISO 22674, Type 4

Thickness	Border	REF	Quantity
8 mm	without	102-750-01	1 piece
10 mm	without	102-751-01	1 piece
12 mm	10 mm	102-752-01	1 piece
13.5 mm	10 mm	102-753-01	1 piece
15 mm	10 mm	102-754-01	1 piece
18 mm	10 mm	102-755-01	1 piece
20 mm	10 mm	102-756-01	1 piece
25 mm	10 mm	102-757-01	1 piece

CE⁰⁴⁸³

Technical data

0.2% Yield strength $R_{p0.2}$	364 MPa
Tensile strength R_m	506 MPa
Hardness	281 HV 10
Elongation A_5	5.9 %
Modulus of elasticity E	202 GPa
Density	8.5 g/cm ³
CTE 25–500 °C / 77–932 °F	$14.1 \times 10^{-6} \text{ K}^{-1}$
Solidus temperature	1320 °C / 2408 °F
Liquidus temperature	1420 °C / 2588 °F

Composition (percentage by mass)

Co	Cr	W	Si
60.5	28.0	9.0	1.5

Additional elements < 1 %: Fe, Mn, N, Nb



remanium® secra

CoCr bonding alloy with maximum reliability potential during processing. Excellent casting behavior, including vacuum pressure casting.

Advantages:

- reliable melting and casting characteristics, especially with vacuum/pressure casting, resulting from the narrow melting range
- small ingots (4 g) allow exact dosage of the alloy: ideal and economical filling of the crucible
- no danger of spattering or increased slagging
- high mechanical strength thanks to tantalum-based crystal structure reinforcement
- enhanced firing behavior of the veneering ceramics through low oxidation
- polished surface has a radiant lustre due to high chrome content

Indication: crowns and bridges, metal ceramics, double crowns, implant supported supra-structures, Maryland bridges, secondary parts for cast partial dentures (combination works)

Norm: DIN EN ISO 9693, DIN EN ISO 22674

Technical data

0.2% Yield strength $R_{p0.2}$	760 MPa
Tensile strength R_m	940 MPa
Hardness	340 HV 10
Elongation A_5	5.3 %
Modulus of elasticity E	211 GPa
Density	8.6 g/cm ³
CTE 25–500 °C / 77–932 °F	14.4 x 10 ⁻⁶ K ⁻¹
Solidus temperature	1329 °C / 2424.2 °F
Liquidus temperature	1385 °C / 2525 °F
Weight of casting ingot	4 g

REF 102-631-00	50 g
REF 102-632-00	250 g
REF 102-630-00	1000 g

CE 0483

Composition (percentage by mass)

Co	Cr	W	Mo	Si	Ta
58.0	30.0	5.5	3.0	1.5	1.25

Additional elements < 1 %: N



CoCr alloys



remanium® 2000+

Clinically proven CoCr bonding alloy with a low CTE value.

Advantages:

- exceptionally low viscosity
- flexibility in casting: can be melt in a high frequency induction casting unit, or with propane/oxygen torch
- increased efficiency
- no oxide firing required
- suitable for laser welding because it is carbon-free

Indication: crowns and bridges, metal ceramics, double crowns, implant supported supra-structures, Maryland bridges, secondary parts for cast partial dentures (combination works)

Norm: DIN EN ISO 9693, DIN EN ISO 22674

Technical data

0.2% Yield strength $R_{p0.2}$	700 MPa
Tensile strength R_m	900 MPa
Hardness	340 HV 10
Elongation A_5	7 %
Modulus of elasticity E	200 GPa
Density	8.6 g/cm ³
CTE 25–500 °C / 77–932 °F	$14 \times 10^{-6} \text{ K}^{-1}$
Solidus temperature	1290 °C / 2354 °F
Liquidus temperature	1415 °C / 2579 °F
Weight of casting ingot	6 g

REF 102-601-10	50 g
REF 102-602-10	250 g
REF 102-600-10	1000 g

CE 0483

Composition (percentage by mass)

Co	Cr	Mo	W	Si
63.0	23.0	7.0	5.0	1.5

Additional elements < 1 %: Mn, N

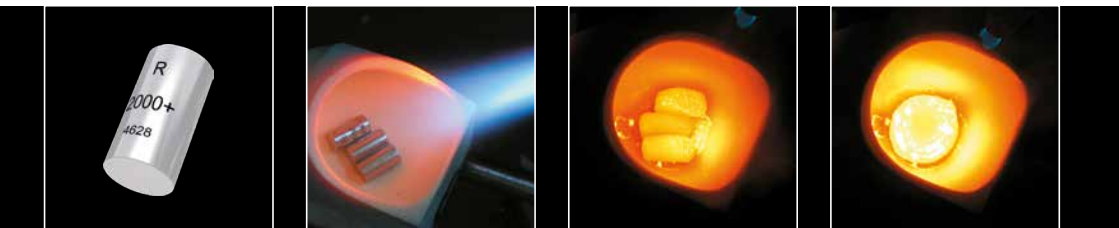

remanium® 2001

CoCr bonding alloy. Easy processing properties.

Advantages:

- exceptionally low viscosity
- flexibility in casting: can be melt in a high frequency induction casting unit, or with propane/oxygen torch
- rapid processing: no oxide firing cycle required
- suitable for laser welding because it is carbon-free

Indication: crowns and bridges, metal ceramics, double crowns, Maryland bridges

Norm: DIN EN ISO 9693, DIN EN ISO 22674

Technical data

0.2% Yield strength $R_{p0.2}$	660 MPa
Tensile strength R_m	850 MPa
Hardness	336 HV 10
Elongation A_5	3,5 %
Modulus of elasticity E	195 GPa
Density	8.6 g/cm ³
CTE 25–500 °C / 77–932 °F	14.2 x 10 ⁻⁶ K ⁻¹
Solidus temperature	1325 °C / 2417 °F
Liquidus temperature	1415 °C / 2579 °F
Weight of casting ingot	6 g

REF 102-600-02	50 g
REF 102-600-01	1000 g

CE 0483

Composition (percentage by mass)

Co	Cr	Mo	W	Si
63.0	23.0	7.3	4.3	1.6

Additional elements < 1 %: Mn, N



CoCr alloys



remanium® LFC

CoCr bonding alloy with a high CTE value for low-fusing, high-expansion veneering ceramics.

Advantages:

- specialised bonding alloy for use with low fusing ceramics within the suitable CTE range (LFC)
- excellent melting and casting behavior with all melting and casting techniques
- easy trimming and polishing
- free from nickel and beryllium
- high mechanical strength
- good laser weldability

Indication: crowns and bridges, metal ceramics, double crowns, secondary parts for cast partial dentures (combination works)

Norm: DIN EN ISO 9693, DIN EN ISO 22674

Technical data

0.2% Yield strength $R_{p0.2}$	660 MPa
Tensile strength R_m	950 MPa
Hardness	315 HV 10
Elongation A_5	11 %
Modulus of elasticity E	200 GPa
Density	8.2 g/cm ³
CTE 25–500 °C / 77–932 °F	15.9 x 10 ⁻⁶ K ⁻¹
Solidus temperature	1280 °C / 2336 °F
Liquidus temperature	1350 °C / 2462 °F
Weight of casting ingot	6 g

REF 102-642-00	250 g
REF 102-640-00	1000 g

CE 0483

Composition (percentage by mass)

Co	Cr	Fe	Mo	Mn
33.0	30.0	29.0	5.0	1.5

Additional elements < 1 %: C, N, Si



remanium® CS+

NiCr bonding alloy with outstanding ceramic bond.
Square ingots for quick, reliable casting.

Advantages:

- excellent ceramic bond – even after multiple bakes
- no slow cooling required when baking ceramics
- beryllium free, biocompatible
- reliable melting and casting characteristics
- maximum corrosion resistance
- excellent soldering and laser welding properties
- easy polishing and high lustre

Indication: crowns and bridges, metal ceramics, double crowns, implant supported supra-structures, Maryland bridges

Norm: DIN EN ISO 9693, DIN EN ISO 22674

Technical data

0.2% Yield strength $R_{p0.2}$	340 MPa
Tensile strength R_m	580 MPa
Hardness	195 HV 10
Elongation A_5	15 %
Modulus of elasticity E	170 GPa
Density	8.2 g/cm ³
CTE 25–500 °C / 77–932 °F	14 x 10 ⁻⁶ K ⁻¹
Solidus temperature	1260 °C / 2300 °F
Liquidus temperature	1350 °C / 2462 °F
Weight of casting ingot	5 g

REF 102-401-00	50 g
REF 102-402-00	250 g
REF 102-403-00	1000 g

CE 0483

Composition (percentage by mass)

Ni	Cr	Mo	Si	Fe
61.0	26.0	11.0	1.5	1.2

Additional elements < 1 %: Co



NiCr alloys



remanium® CSe

NiCr bonding alloy with user-friendly processing properties.

Advantages:

- easy handling due to reduced surface hardness
- no slow cooling required when firing ceramics
- beryllium free, biocompatible
- fast and easy to melt
- excellent laser weldability

Indication: crowns and bridges, metal ceramics, double crowns, implant supported supra-structures, Maryland bridges

Norm: DIN EN ISO 9693, DIN EN ISO 22674

Technical data

0.2% Yield strength $R_{p0.2}$	340 MPa
Tensile strength R_m	580 MPa
Hardness	195 HV 10
Elongation A_5	15 %
Modulus of elasticity E	170 GPa
Density	8.2 g/cm ³
CTE 25–500 °C / 77–932 °F	14 x 10 ⁻⁶ K ⁻¹
Solidus temperature	1260 °C / 2300 °F
Liquidus temperature	1350 °C / 2462 °F
Weight of casting ingot	6 g

REF 102-401-05	50 g
REF 102-403-05	1000 g

CE 0483

Composition (percentage by mass)

Ni	Cr	Mo	Si	Fe
61.0	26.0	11.0	1.5	1.2

Additional elements < 1 %: Co

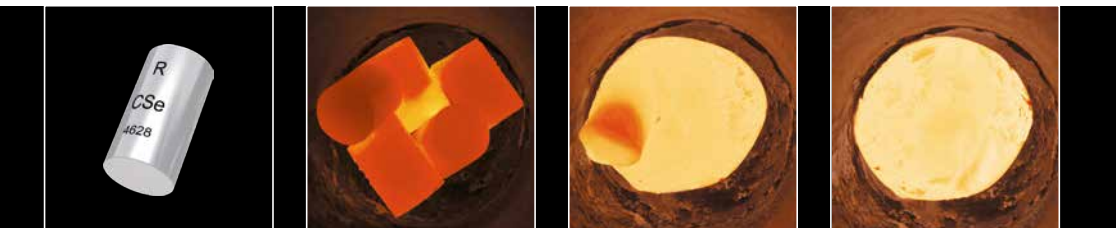
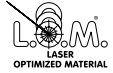

remanium® G-soft

Proven NiCr alloy for crown and bridge work and composite veneering.

Advantages:

- reliable melting and casting characteristics
- easy polishing and high lustre
- high corrosion resistance
- high strength for delicate frameworks
- ideal for melting with a flame, as it does not spray during melting

Indication: crowns and bridges, double crowns, implant supported supra-structures, Maryland bridges
Norm: DIN EN ISO 22674

Technical data

0.2% Yield strength $R_{p0.2}$	400 MPa
Tensile strength R_m	700 MPa
Hardness	210 HV 10
Elongation A_5	10 %
Modulus of elasticity E	165 GPa
Density	8.2 g/cm ³
Solidus temperature	1210 °C / 2210 °F
Liquidus temperature	1240 °C / 2264 °F
Weight of casting ingot	6 g

REF 100-001-00	1000 g
----------------	--------

CE 0483

Composition (percentage by mass)

Ni	Cr	Mo	Si
66.0	26.5	5.0	1.5

Additional elements < 1 %: B, Mn

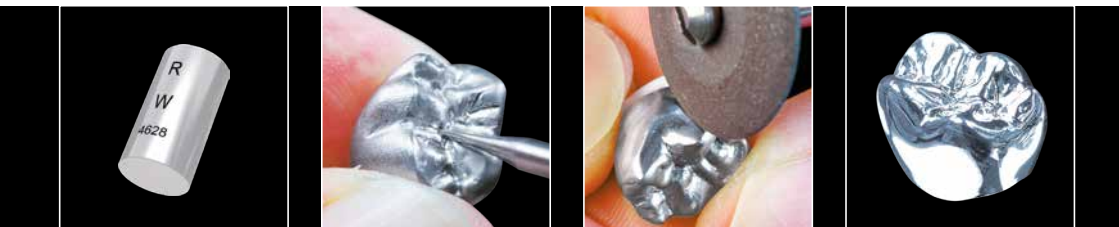

Crowns and bridges

Titanium



Tritan

Titanium grade 1

Norm: DIN 17862, DIN EN ISO 22674

min. 99.5 % titanium

Good casting properties in casting machines designed specifically for titanium.

Dentaurum provides, under the brandname Tritan, pure titanium in ingots of different sizes which can be used in the titanium casting machines.

Each ingot is marked with the name Tritan, the purity grade and batch number. Thus, Dentaurum ensures that only DIN Standard Tritan titanium of proper purity grade is used for dental castings.

Advantages:

- minimal oxygen content. Very good castability
- 5 different weight units ensure accurate dispensing
- maximum purity

Indication: crowns and bridges, implant supported supra-structures, cast partial dentures

Height ingot	Weight of casting ingot	REF	Quantity
11.8 mm	18 g	100-100-50	250 g
14.3 mm	22 g	100-101-50	500 g
14.3 mm	31 g	100-102-50	500 g
14.3 mm	36 g	100-103-50	500 g
15.8 mm	40 g	100-105-50	500 g

CE 0483

Technical data

0.2% Yield strength $R_{p0.2}$	460 MPa
Tensile strength R_m	560 MPa
Hardness	200 HV 10
Modulus of elasticity E	110 GPa
Density	4.5 g/cm ³
Melting point	1668 °C / 3034.4 °F
CTE 25–500 °C / 77–932 °F	9.6 x 10 ⁻⁶ K ⁻¹



rematitan® M

Titanium grade 4

Norm: DIN 17862, DIN EN ISO 22674

min. 99.5 % titanium

Dentaurum provides, under the brandname rematitan® M, pure titanium in ingots which can be used in the titanium casting machines. Each ingot is marked with the name rematitan® M, the purity grade and batch number. Thus, Dentaurum ensures that only DIN Standard rematitan® M titanium of proper purity grade is used for dental castings.

Advantages:

- higher figures in elongation, proof stress and elasticity
- maximum purity

Indication: implant supported supra-structures, cast partial dentures



Height ingot	Weight of casting ingot	REF	Quantity
14.3 mm	31 g	100-107-00	1000 g

CE 0483

Technical data

0.2% Yield strength $R_{p0.2}$	600 MPa
Tensile strength R_m	680 MPa
Hardness	210 HV 10
Modulus of elasticity E	120 GPa
Density	4.5 g/cm ³
Melting point	1668 °C / 3034.4 °F



Solders and welding wires



CoCrMo-Sold 1

- pure CoCrMo solder, nickel -free
- corrosion-resistant, no discoloration
- flows easily
- without flux

Area of application:

- all CoCr bonding alloys for presoldering
- all CoCr cast partial denture alloys

Recommended Flux: rema® Flux 1, REF 102-304-00

Solidus temperature	1110 °C / 2030 °F
Liquidus temperature	1162 °C / 2123.6 °F

REF 102-306-00	3 g
----------------	-----

CE 0483

Composition (percentage by mass)

Co	Cr	Mo	Si	B
69.8	19.0	5.0	5.0	1.2

without flux



NiCr-Sold 1

- pure NiCrMo solder
- flows easily
- without flux

Area of application:

- all NiCr bonding alloys for presoldering
- all NiCr alloys for crown and bridge work

Recommended Flux: rema® Flux 1, REF 102-304-00

Solidus temperature	1115 °C / 2039 °F
Liquidus temperature	1165 °C / 2129 °F

REF 102-302-00	3 g
----------------	-----

CE 0483

Composition (percentage by mass)

Ni	Cr	Mo	Si	B
63.0	19.0	10.0	7.0	1.0

without flux



rema® Flux 1

- flux for CoCrMo-Sold 1 and NiCr-Sold 1
- excellent wetting of alloys
- guarantees good flowability of the solder

REF 102-304-00	25 g
----------------	------



Soldering rod for chrome-cobalt

- incl. flux
- no discoloration
- all CoCr cast partial denture alloys

Liquidus temperature	1100 °C / 2012 °F
----------------------	-------------------

REF 142-100-50	6 rods
----------------	--------

CE 0483

Composition (percentage by mass)

Co	Cr	Ni	Si	W
50.0	18.0	17.0	8.0	4.0

White gold solder

- in rods
- ready fluxed
- purity: ct 18.6
- cadmium free

Not permitted for intra-oral use.

ø	1–1.1 mm
Working temperature	950 °C / 1742 °F

REF 380-600-50	1.6 g
----------------	-------

Composition (percentage by mass)

Au	Ni	Zn
77.0	16.0	6.0

with flux



Universal silver solder

- in rods
- ready fluxed
- cadmium free

Not permitted for intra-oral use.

ø	1–1.1 mm
Working temperature	700 °C / 1292 °F

REF 380-604-50	1.2 g
REF 380-604-60	10 x 1.2 g

Composition (percentage by mass)

Ag	Zn	Cu
59.0	24.0	16.0

with flux



Universal silver solder

- in coils
- without flux
- cadmium free

Not permitted for intra-oral use.

Working temperature	700 °C / 1292 °F
---------------------	------------------

REF 380-704-50	10 g
----------------	------

Composition (percentage by mass)

Ag	Zn	Cu
59.0	25.0	16.0

without flux



Dentaflux® flux

- universal flux
- for all alloys
- especially for connections between precious and non-precious alloys

REF 681-100-00	50 g
----------------	------



Solders and welding wires



CoCr welding wire

Various dimensions to be used as a filling soldering wire for all CoCr alloys.

ø	Length	REF	Quantity
0.25 mm / 10	2 m	528-215-10	1 piece
0.35 mm / 14	2 m	528-210-10	1 piece
0.50 mm / 20	2 m	528-200-10	1 piece

CE 0483

Composition (percentage by mass)

Co	Cr	Mo
65.0	28.0	5.5

Additional elements < 1 %: Mn, Si

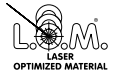

NiCr welding wire

For laser welding NiCr based alloys. Specifically for high grade alloys such as remanium® CS+, CSe and G-soft.

ø	Length	REF	Quantity
0.50 mm / 20	2 m	528-220-00	1 piece

CE 0483

Composition (percentage by mass)

Ni	Cr	Mo	Nb
63.0	22.0	9.0	3.5

Additional elements < 1 %: Al, Co, Fe, Ti



rematitan® wire on coils

Titanium grade 1

Norm: DIN 17850

For laser welding.

Recommended as filler material for laser welding, e.g. with titanium RPE appliances (Titan hyrax® Maxi – 12).

ø	Length	REF	Quantity
0.40 mm / 16	2 m	528-039-50	1 piece
0.70 mm / 28	2 m	528-040-50	1 piece

CE 0483

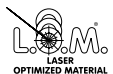

rematitan® straight wire

Titanium grade 1

Norm: DIN 17850

For laser welding.

Recommended as reinforcing wire for fixed titanium RPE appliances (Titan hyrax® Maxi – 12).

ø	Length	REF	Quantity
1.00 mm / 39	each 100 mm	528-041-00	10 pieces
1.20 mm / 47	each 100 mm	528-042-00	10 pieces

CE 0483



rematitan® straight wire

Titanium grade 4

Norm: DIN 17850

For laser welding.

Recommended for axes of swing locks.

ø	Length	REF	Quantity
1.50 mm / 59	50 mm	528-050-00	1 piece

CE 0483



rematitan® straight wire

Titanium grade 1

Norm: DIN 17850

For laser welding.

ø rolled	Length	REF	Quantity
0.25 x 3.0 mm / 10 x 118	each 100 mm	528-044-00	10 pieces
0.5 x 1.5 mm / 20 x 59	each 100 mm	528-043-00	10 pieces

CE 0483









Attachments and accessories

rematitan® bar

Titanium grade 4

rematitan® bars have the same cross-section as precious alloy bars.

All respective auxiliary parts can be used.

	Designation	Dimensions (L x W x H)	REF	Quantity
	Bar hinge macro + Bar sleeve + Retention	40 x 2.1 x 3.0 mm	210-010-00	1 piece
	Bar attachment macro + Bar sleeve + Retention	40 x 2.1 x 3.0 mm	210-011-00	1 piece
	Bar sleeve macro + Retention		210-012-00	1 pair
	Bar hinge micro + Bar sleeve + Retention	40 x 1.6 x 2.25 mm	210-020-00	1 piece
	Bar attachment micro + Bar sleeve + Retention	40 x 1.6 x 2.3 mm	210-021-00	1 piece
	Bar sleeve micro + Retention		210-022-00	1 pair

CE⁰⁴⁸³



Parallel holder for bar

Available in 2 designs for bar hinges and bar attachments.

Version	Width	REF	Quantity
micro	1.6 mm	210-023-00	1 piece
macro	2.1 mm	210-013-00	1 piece

rema® CC

Universal crown and bridge speed investment for all indications, alloys and press ceramics.

Advantages:

- a single investment for all applications
- maximum stability with all preheating techniques
- precisely targeted expansion control for precious metal alloys, non-precious alloys and press ceramics
- free choice of investment systems (metal ring or ringless)
- great reliability of production batches due to extensive testing
- targeted accuracy even with long-span bridges

Norm: DIN EN ISO 15912

Type 1

Class 1, 2

Working time	8 min
Preheating	consistent preheating, preheating with holding time, speed preheating
Preheating temperature	700–900 °C / 1292–1652 °F
Compression resistance	3 MPa
Color	white

REF 105-840-00	6 kg (60 x 100 g)
REF 105-841-00	6 kg (38 x 160 g)



rema® CC mixing liquid

Approx. 1000 ml mixing liquid are sufficient for 6 kg investment material.

Caution: Mixing liquid is sensitive to frost!
Please order prior to frost season.

REF 105-845-00	1 l
----------------	-----



rema® CC HE liquid

Special mixing liquid for very high expansion. The liquid can be used when particularly high expansion of the investment is required (e.g. telescopic restorations).

The standard mixing liquid (REF 105-845-00) is used for all other cases.

Caution: Mixing liquid is sensitive to frost!
Please order prior to frost season.

REF 105-846-00	1 l
----------------	-----



Crowns and bridges

Investment materials



rema® TT

Special investment material for telescopic crowns made from non-precious metal alloys.

Advantages:

- exactly suited for the telescopic technique using non-precious metal alloys
- possible to control the fit and friction exactly
- very large overall expansion
- high stability for every size casting ring and type of preheating furnace
- high degree of surface smoothness

Norm: DIN EN ISO 15912

Type 1

Class 1, 2

Working time	4–5 min
Preheating	consistent preheating, preheating with holding time, speed preheating
Preheating temperature	900–950 °C / 1652–1742 °F
Compression resistance	9 MPa
Color	green

REF 106-740-00 | 4 kg (25 x 160 g)



rema® TT mixing liquid

Approx. 700 ml mixing liquid are sufficient for 4 kg investment material.

Caution: Mixing liquid is sensitive to frost! Please order prior to frost season.

REF 106-707-00 | 1 l

Castorit® all speed

High-expansion speed investment, individually controllable for all alloys (except titanium).

Advantages:

- casting ring can be placed into the furnace at final temperature (950 °C / 1742 °F) for speed preheating or preheated in stages overnight
- used for all alloy groups
- the high overall expansion provides precision of fit
- long working times and a very creamy mixing consistency
- castings with extremely smooth surfaces ensure uniform quality and exact reproduction of the pattern

Norm: DIN EN ISO 15912

Type 1

Class 1, 2

Working time	6–8 min
Preheating	consistent preheating, preheating with holding time, speed preheating
Preheating temperature	700–950 °C / 1292–1742 °F
Compression resistance	9–11 MPa
Color	white

REF 105-741-00	6 kg (40 g x 150 g)
REF 105-742-80	20 kg (8 x 2.5 kg)



Castorit® all speed mixing liquid

Approx. 1000 ml mixing liquid are sufficient for 6 kg investment material.

Caution: Mixing liquid is sensitive to frost!
Please order prior to frost season.

REF 105-745-00	1 l
----------------	-----



Investment materials



Castorit®-super C

Proven user-friendly precision investment for CoCr and NiCr alloys.

Advantages:

- high thermal stability and robustness
- consistent highly accurate fit
- easy devesting behavior
- creamy mixing consistency
- silky smooth casting surfaces

Norm: DIN EN ISO 15912

Type 1

Class 1

Working time	4–5 min
Preheating	consistent preheating, preheating with holding time
Preheating temperature	950 °C / 1742 °F
Compression resistance	3–4 MPa
Color	white

REF 106-721-00	6 kg (40 x 150 g)
----------------	-------------------



Castorit®-super C mixing liquid

Approx. 1400 ml mixing liquid are sufficient for 6 kg investment material.

Caution: Mixing liquid is sensitive to frost!
Please order prior to frost season.

REF 106-704-00	1 l
----------------	-----

Trivest

High-expansion, individually controllable investment for non-precious metal alloys.

Advantages:

- the expansion can be adjusted
- very high overall expansion
- easy devesting and sandblasting behavior
- long working time

Norm: DIN EN ISO 15912

Type 1

Class 1

Working time	5–6 min
Preheating	consistent preheating, preheating with holding time
Preheating temperature	950 °C / 1742 °F
Compression resistance	3–4 MPa
Color	yellow

REF 106-731-00	6 kg (40 x 150 g)
----------------	-------------------



Trivest mixing liquid

Approx. 1200 ml mixing liquid are sufficient for 6 kg investment material.

Caution: Mixing liquid is sensitive to frost!

Please order prior to frost season.

REF 106-706-00	1 l
----------------	-----



Power Liquid mixing liquid, concentrate

For rema® Exakt, rema® Exakt F, rema® dynamic S, rema® blue, Castorit®-super C and Trivest.

- reduces transport costs
- expansion can be individually adjusted

Approx. 2000 ml mixing liquid are sufficient for 20 kg investment material.

Approx. 800 ml mixing liquid are sufficient for 6 kg investment material.

Caution: Mixing liquid is sensitive to frost!

Please order prior to frost season.

REF 105-502-00	1 l
----------------	-----



Investment materials



ceraMotion® press invest

Investment material for press ceramic.

Advantages:

- smooth and dense surface
- easy devesting
- detailed press results
- flexibility due to optimized processing time
- excellent fit due to control of expansion

Norm: DIN EN ISO 15912

Type 1

Class 1, 2

Working time	8–9 min
Preheating	preheating with holding time, speed preheating
Preheating temperature	850 °C / 1562 °F
Compression resistance	3–4 MPa
Color	white

REF 275-010-00

2500 g



ceraMotion® press invest mixing liquid

Mixing liquid for ceraMotion® press invest. Approx. 500 ml mixing liquid are sufficient for 2.5 kg investment material.

Caution: Mixing liquid is sensitive to frost!
Please order prior to frost season.

REF 275-015-00

1 l

Ring former

Used for ø 12 mm press plunger.

Special ring former with silicone ring included for press ceramic investing procedures.

The silicone ring enables the casting ring to be easily removed after the investment has set.

Capacity	REF	Quantity
100 g	260-360-10	1 piece
200 g	260-360-20	1 piece

**Press plunger**

ø 12 mm

Reusable aluminium oxide press plunger.

REF 260-365-01

1 piece

**Disposable press plunger**

ø 12 mm

Disposable investment press plunger for single use.

No time-consuming cleaning of the press plunger.

REF 260-365-05

20 pieces

**Disposable press plunger**

ø 13 mm

Investment press plunger for single use. No time-consuming cleaning of the press plunger.

Used with lithium disilicate ceramic (e.g. ceraMotion® LiSi).

REF 260-365-13

20 pieces

NEW

Crowns and bridges

Investment materials



rematitan® Plus

Universal titanium investment for all areas.

Advantages:

- suitable for use both in cast partial denture work and the entire range of crown and bridge work
- expansion is controlled using 2 mixing liquids (cast partial dentures and crowns and bridges)
- prevents the reaction of mould material and molten titanium to a high degree
- use of pure refractory materials

Norm: DIN EN ISO 15912

Type 1, 2

Class 1

Working time	3–4 min
Preheating	preheating with holding time
Preheating temperature	1000 °C / 1832 °F
Compression resistance	5–8 MPa
Color	white

REF 107-600-00	20 kg (80 x 250 g)
REF 107-610-00	8 kg (32 x 250 g)



rematitan® Plus mixing liquid for framework casting

Approx. 3200 ml mixing liquid are sufficient for 20 kg investment material.

Caution: Mixing liquid is sensitive to frost! Please order prior to frost season.

REF 107-601-00	1 l
----------------	-----



rematitan® Plus mixing liquid for crowns and bridges

Approx. 3200 ml mixing liquid are sufficient for 20 kg investment material.

Caution: Mixing liquid is sensitive to frost! Please order prior to frost season.

REF 107-602-00	1 l
----------------	-----



rematitan® cold model hardener

For hardening rematitan® Plus investment models.

- straightforward handling
- environment friendly product
- for hard, sharp-edged rematitan® Plus refractory models
- improved adhesion of wax profiles

REF 167-305-00	1 l
----------------	-----

StarWax CB modelling wax

Advantages:

- purely organic
- ideal wax-up properties
- short melting range, can be applied optimally in spots or larger surfaces
- highly resilient – no risk of fracturing
- selected colors prevent a tiredness of the eyes
- outstanding carving properties

Color	REF	Quantity
green	120-201-00	50 g
blue	120-208-00	50 g
red	120-207-00	50 g
beige	120-202-00	50 g
grey	120-203-00	50 g
Dentin A1	120-204-00	50 g
Dentin B3	120-205-00	50 g
transparent	120-206-00	50 g



StarWax CB grey contains a very small proportion of inorganic ingredients.

Waxes



StarWax C cervical wax

Advantages:

- ideal base wax for all applications
- optimal accuracy due to minimum shrinkage
- soft, elastic quality
- purely organic

Color	REF	Quantity
red	120-212-00	50 g



StarWax M milling wax

Advantages:

- outstanding milling and carving properties
- highly elastic, reproduces shapes exactly
- smooth surfaces – will not smear
- purely organic

Color	REF	Quantity
blue	120-211-00	50 g



StarWax D dipping wax

Advantages:

- highly elastic – ideal for fabricating uniformly thick wax copings
- granulate for comfortable dosing
- purely organic

Working temperature approx. 90 °C / 194 °F

Color	REF	Quantity
orange	120-213-50	100 g

Special casting wax

according to Gründler

- soft and stress-free
- base wax for the dual-wax technique

Color	REF	Quantity
red	123-800-00	50 g



Sticky wax

- good adhesive effect on all materials
- ideal for the fixation of retentive or support elements, repair and soldering work

Melting point	Color	REF	Quantity
71 °C / 159.8 °F	red	122-300-00	60 g



Sprue bar

- stabilization of the wax pattern
- prevents distortion of bridges
- controlled contraction of the metal

ø	Color	REF	Quantity
4.0 mm	blue	111-315-00	100 pieces

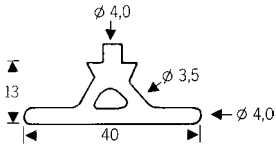

Waxes



Wax wire on roll

- for sprues
- two qualities of wax
- smooth surfaces
- easy waxing due to fast solidification
- rigid and stress-free after application

ø	Soft-Quality REF (blue)	Standard-Quality REF (violet)	Quantity
2.0 mm	111-720-00		250 g
2.5 mm	111-825-00	111-425-00	250 g
3.0 mm	111-830-00	111-430-00	250 g
3.5 mm	111-835-00	111-435-00	250 g
4.0 mm	111-840-00	111-440-00	250 g
5.0 mm	111-850-00	111-450-00	250 g



Wax wire rod

- for retentions etc.
- easily adaptable

ø	Color	REF	Quantity
● 0.6 mm	blue	111-106-00	12 g
● 0.8 mm	blue	111-108-00	25 g
● 0.9 mm	green	111-109-00	25 g
● 1.0 mm	green	111-110-00	25 g
● 1.2 mm	green	111-112-00	37 g
● 1.5 mm	green	111-115-00	50 g
● 2.0 mm	blue	111-120-00	50 g



Wax stick

- extra hard quality
- very good stabilization of the patterns

ø	Color	REF	Quantity
● 3.0 mm	turquoise	111-630-00	250 g
● 4.0 mm	turquoise	111-640-00	250 g
● 5.0 mm	turquoise	111-650-00	250 g

Kera-Vlies®

Liner for metal casting rings in the crown and bridge technique.

- Kera-Vlies® is now manufactured in enhanced biological quality.
- It complies with the most stringent regulations of industrial medical guidelines
- free expansion through fleece-like material
- Kera-Vlies® is fire-proof and does not release any toxic fumes
- easier deflasking after casting



Thickness x width	Length	REF	Quantity
1.0 x 50 mm	25 m	127-250-00	1 piece
2.0 x 50 mm	15 m	127-251-00	1 piece

Model and casting ring tongs

REF 127-410-00	1 piece
----------------	---------

- angled jaws give more secure grip for refractory models and casting rings (Sizes 1/3/6)
- stainless

Length: 36.0 cm



Casting ring – stainless steel

- heat-resistant
- sturdy design

Size	ø	Height	REF	Quantity
1	30 mm	55 mm	106-800-00	1 piece
3	48 mm	55 mm	106-801-00	1 piece
6	65 mm	55 mm	106-802-00	1 piece



Sprue former

- highly durable flexible rubber
- with metal reinforced base plate

Size	REF	Quantity
1	106-820-00	1 piece
3	106-821-00	1 piece
6	106-822-00	1 piece



Base D1 – Casting ring base

REF 106-825-00	1 piece
----------------	---------

- universal casting ring base for all casting ring sizes from size 3 up available in crowns and bridges
 - ring may also be fixed outside of the casting ring center, individual adaptation of the wax pattern
 - rubber base ensures a safe seal
- The casting ring is not supplied with the base.



Investment systems



Casting ring, flexible, for the rematitan® investment system

- can be reused
- the rings are dimensioned to fit over the casting bases

Size	REF	Quantity
3	106-840-00	1 piece
6	106-841-00	1 piece
9	106-842-00	1 piece



Casting base with sprue former

- application with metal casting rings and flexible casting rings
- solid plastic

Size	REF	Quantity
3	106-850-01	1 piece
6	106-851-01	1 piece
9	106-852-01	1 piece



Fixing ring

- connection of the ring base and metal casting rings

Size	REF	Quantity
3	106-845-00	1 piece
6	106-846-00	1 piece
9	106-847-00	1 piece



Casting sprue former titanium

- Application for rematitan®/autocast casting machines.
Material: Plastic

REF 090-027-00	5 pieces
----------------	----------

Die Lube

Separating agent

REF 112-000-00	50 g
----------------	------

Application:

Separation of dies made from dental stone, resin, and metal against wax, porcelain and acrylic.

- guarantees easy removal of waxed-up copings etc.
- can be used instead of milling oil
- will not react while duplicating with silicone
- integrated brush in the cap



Folident replacement foil

Thickness	REF	Quantity
0.6 mm	120-131-00	100 pieces
0.1 mm	120-132-00	200 pieces



Conical pins

Accessory which allows for optimum results when laser welding gold to CoCr alloys.

Tip:

For easier laser welding, the pin is affixed to the secondary crown.

The pin is modeled to the denture base and welded to it later.

Color	REF	Quantity
green	111-901-00	10 pieces



Lubrofilm®

Double function

• Silicone surface tension reducing agent

Allows bubble-free pouring of investment into silicone mould.

• Wax surface tension reducing agent

Reduces surface tension on wax and facilitates investing.

REF 112-050-00	100 ml
REF 112-051-00	1 l



Accessories



Rapidur®

Synthetic dental stone

- extra hard, low expansion
- quick-setting

Application:

orthodontics, cast partial denture work,

precious metal, acrylics, ceramics

Norm: DIN EN ISO 6873

Class 4

Mixing ratio (g : ml)	100 : 24
Setting expansion	max. 0.15 %
Working time	min. 3 min
Compression resistance	min. 35 MPa
Setting time	max. 30 min
Color	white

REF 164-450-00

6 kg



Mixing bowl

For plaster, impression and investment materials, easy to clean.

Capacity	REF	Quantity
400 ml	164-651-00	1 piece
600 ml	164-650-00	1 piece

Dowel pin

Brass. Smooth clean surfaces. Conical root portion, bevelled on one side.

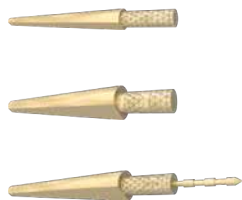

Length	Head ø	Type	REF	Quantity
22 mm	1.9 mm	A	319-401-00	100 pieces
22 mm	2.0 mm	B	319-402-00	100 pieces
28.9 mm		D	319-405-00	1000 pieces

Type D: Medium size (similar to REF 319-402-00) with plunger for direct fixation – without seating device – in the impression due to the special graduation of the plunger.

Saw

For orthodontics/prosthetics.
Small saw with replaceable blades.

Contents:

Saw incl. 3 saw blades

REF 180-702-00

1 piece

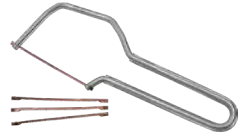

Saw blade

For saw.

Length	REF	Quantity
70 mm	180-703-00	5 pieces



All print media are available as PDF downloads at
www.dentaurum-implants.de



conica

 **tiologic**
TWINFIT

platform

IT'S MY CHOICE.



DENTAURUM **ONLINE SHOP**
shop.dentaurum.com





Abutment Switch.
2 connector geometries – 1 implant.

conical



The new patented implant system tiologic® TWINFIT offers maximum flexibility from insertion to prosthetic restoration. The decision on which abutment – conical or platform – is best for your patient is yours. This gives you flexibility and the opportunity for individual choices.

- Conical or Platform – Abutment Switch.
- 2 connector geometries on one implant.
- Depth-stop system for situational single use.
- Comprehensive assortment of prosthetics to suit all requirements.
- CAD/CAM, optimized for a flexible, digitized workflow.

platform





Digital workflow.

The patented implant system tioLogic® TWINFIT is designed to suit a digital workflow. As your digital partner, Dentaureum places great value on process sequences that are efficient and easy to understand, using materials from us – from scanning through to manufacture. It goes without saying that the sequences can be adapted to suit your individual needs.





Complete solution for the CAD/CAM processes.

tioLogic® DIGITAL. from Dentaurem Implants provides a coordinated complete solution for CAD/CAM processes on tioLogic® implants.

The product range includes all data and original components for the fabrication of customized, one-piece abutments, hybrid abutments as well as bar and bridge restorations with CAD/CAM technology using certified materials "MADE IN GERMANY – MADE BY DENTAURUM".

Data sets for all software providers.

Once you have chosen a software provider, the corresponding CAD/CAM data set can be downloaded free of charge. It contains all of the data for each kind of restoration in one complete package:

- customized one-piece abutments
- hybrid abutments
- bar and bridge restorations

Original components direct from the manufacturer.

The scan abutments were specially designed for precise digital recording of the geometry directly on the implant shoulder.

Original tioLogic® CAD/CAM titanium blocks are available for the manufacture of individual one-piece abutments both in-house and off-site in manufacturing centers certified by Dentaurem Implants.

Certified manufacturing centers as partners.

You have not chosen a particular manufacturing center to work with so far? Please refer to the website

www.dentaurem-implants.de/cadcam



Alloys	Page	208
Titanium	Page	212
Solders and welding wires	Page	214
Investment materials	Page	216
Fine investment materials	Page	222
Duplicating materials	Page	223
Duplicating materials – accessories	Page	228
Waxes	Page	232
Accessories	Page	238



Cast partial denture.

Competence through experience.

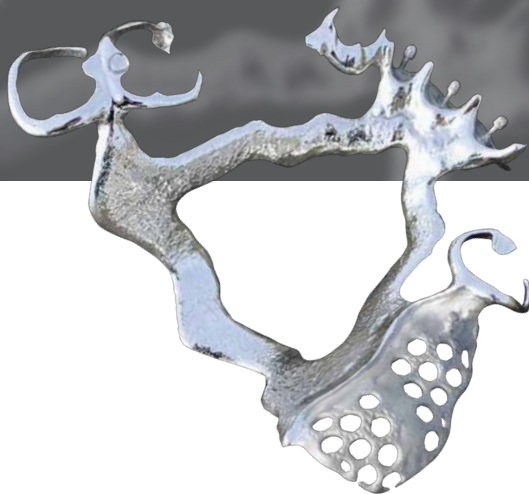

DENTAURUM
**ONLINE
SHOP**
shop.dentaurum.com



Cast partial dentures – the digital way.

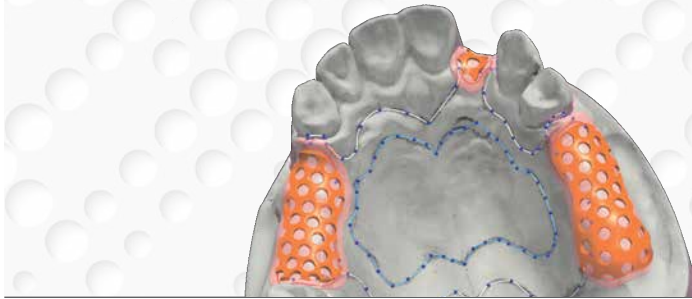

remanium® for all manufacturing technologies.

Cast partial dentures can either be cast using the conventional method of duplication or be fabricated using the SLM process (Selective Laser Melting) directly with remanium®. The CAD/Cast process is also a suitable method. The framework is milled from a wax/acrylic blank or plotted for 3D print. Further steps include the conventional techniques of investing and casting.

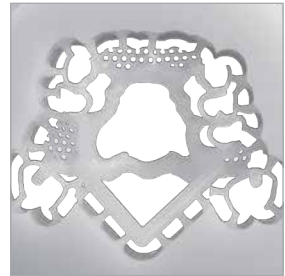
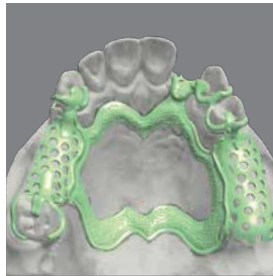

Coordinated products and processes.

When it comes to cast partial dentures and their fabrication, Dentaaurum has a great deal of know-how covering the whole spectrum, including viable alternatives for the future. Coordinating materials and finding effective processes for them has always been one of the company's strengths. One such development is the use of our remanium® powder for the SLM technology (distributor: Concept Laser), where material and process are ideally suited to one another. Milling blanks made of wax/acrylic, specially developed for the CAD/Vest process, and modified investment materials offer possibilities which can redefine the fabrication of cast partial dentures.





The successful system.

The expansion values of our investment materials are matched to our remanium® alloys. Important components such as the duplicating materials are incorporated into the system. A whole range of materials and machines completes this cast partial denture system.

Biocompatible dental restorations.

Alloys, investment materials, waxes and duplicating materials are produced in-house at Dentaaurum in Ispringen under strict quality controls. The use of pure raw materials and the thorough examination of each and every batch guarantee the consistently high quality of our products.

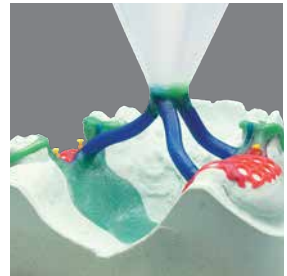

Cast partial denture alloys

For optimum biocompatibility.

Cast partial denture investment materials

Universal qualities.

Duplicating gel

Impressive duplicating qualities.

Duplicating silicone

Fulfils the highest quality standards.

Cast partial denture – wax assortment

For all types of applications and in all thicknesses.

Cast partial denture – accessories

From soldering to duplicating moulds and investment systems to funnel formers.

remanium®

Cast partial denture alloys:

Biocompatible, resistant to corrosion, for universal use.

The superlative from Dentaureum.

Dentaureum has always been renowned for a comprehensive product range with all the materials necessary for fabricating cast partial denture frameworks. The remanium® cast partial denture alloys have a high degree of flexibility and set standards for maximum mechanical loading capacity. For this reason cast partial denture frameworks made of remanium® can be designed to be very thin and delicate.

All Dentaureum cast partial denture alloys provide:

- easy castability.
- prevention of overheating due to mirror effect on melt surface.
- high-gloss surfaces.
- wide range of indications.

Their special advantages:

- remanium® GM 800+ has the highest spring-hardness.
- easiest processing with the cast partial denture alloy remanium® GM 280.

remanium® cast partial denture alloys at a glance.

	remanium® GM 800 +	remanium® GM 380 +	remanium® GM 900	remanium® GM 280																																		
Characteristics	Extra spring-hard universal alloy with a high yield strength for all types of cast partial denture work, type 5.	Time-tested, spring-hard alloy for all types of cast partial denture work, type 5.	Extra spring-hard, modern alloy for all types of cast partial denture work. Excellent laser welding properties as it is carbon-free, type 5.	Spring hard alloy with reduced hardness for the cast partial denture technique.																																		
Product advantages	<ul style="list-style-type: none"> ■ high modulus of elasticity for delicate, yet stable frameworks ■ high fracture resistance due to excellent mechanical properties ■ mirror effect on melt surface ■ high-luster surfaces after electrolytic polishing 	<ul style="list-style-type: none"> ■ mirror effect on melt surface ■ easy preparation and polishing ■ easily activated, high yield strength 	<ul style="list-style-type: none"> ■ harmoniously coordinated, high mechanical parameters ■ easy preparation and polishing due to reduced surface hardness ■ mirror effect indicates the appropriate moment for casting. Prevents overheating of the molten alloy, ensuring smooth clean castings ■ excellent laser welding properties as it is carbon-free 	<ul style="list-style-type: none"> ■ the low hardness enables easy finishing and polishing ■ high elongation at rupture prevents clasp fractures ■ mirror effect indicates the appropriate moment for casting. Prevents overheating of melt ■ very good laser welding properties 																																		
Composition (% by mass)	<table border="1"> <tr><td>Co</td><td>Cr</td><td>Mo</td><td>W</td><td>Si</td></tr> <tr><td>58.3</td><td>32.0</td><td>6.5</td><td>1.5</td><td>1.0</td></tr> </table>	Co	Cr	Mo	W	Si	58.3	32.0	6.5	1.5	1.0	<table border="1"> <tr><td>Co</td><td>Cr</td><td>Mo</td></tr> <tr><td>64.6</td><td>29.0</td><td>4.5</td></tr> </table>	Co	Cr	Mo	64.6	29.0	4.5	<table border="1"> <tr><td>Co</td><td>Cr</td><td>Mo</td><td>Si</td><td>Ta</td></tr> <tr><td>62.0</td><td>30.0</td><td>5.5</td><td>1.2</td><td>1.2</td></tr> </table>	Co	Cr	Mo	Si	Ta	62.0	30.0	5.5	1.2	1.2	<table border="1"> <tr><td>Co</td><td>Cr</td><td>Si</td><td>W</td></tr> <tr><td>61.0</td><td>28.0</td><td>1.5</td><td>8.0</td></tr> </table>	Co	Cr	Si	W	61.0	28.0	1.5	8.0
Co	Cr	Mo	W	Si																																		
58.3	32.0	6.5	1.5	1.0																																		
Co	Cr	Mo																																				
64.6	29.0	4.5																																				
Co	Cr	Mo	Si	Ta																																		
62.0	30.0	5.5	1.2	1.2																																		
Co	Cr	Si	W																																			
61.0	28.0	1.5	8.0																																			
Other < 1%	Mn, N, C	Si, Mn, N, C	N	Nb, Mn, N, C																																		
Summary relevant characteristics																																						
Elasticity	extra spring hard	spring hard	extra spring hard	spring hard																																		
Mirror effect	yes	yes	yes	yes																																		
Finishing and polishing	++	++	++	+++																																		
Laser welding	++	++	+++	+++																																		
Soldering with CoCr solder	++ REF 102-306-00	++ REF 102-306-00	++ REF 102-306-00	++ REF 102-306-00																																		
Mechanical properties																																						
0.2 % yield strength ($R_{p0.2}$)	720 MPa	640 MPa	700 MPa	600 MPa																																		
Tensile strength R_m (MPa)	960 MPa	900 MPa	910 MPa	845 MPa																																		
Elongation A_5	4 %	6.5 %	5 %	11 %																																		
Hardness	370 HV 10	360 HV 10	340 HV 10	280 HV 10																																		
Modulus of elasticity E	230 GPa	220 GPa	210 GPa	190 GPa																																		
Solidus temperature	1240 °C / 2264 °F	1300 °C / 2372 °F	1360 °C / 2480 °F	1320 °C / 2408 °F																																		
Liquidus temperature	1410 °C / 2570 °F	1370 °C / 2498 °F	1410 °C / 2570 °F	1420 °C / 2588 °F																																		
Density	8.2 g/cm ³	8.2 g/cm ³	8.2 g/cm ³	8.6 g/cm ³																																		
Ordering information																																						
Availability	1000 g REF 102-200-10	1000 g REF 102-001-10	1000 g REF 102-250-00	1000 g REF 102-280-00																																		
Safety through certified quality  0483																																						

Optimum biocompatibility: Laboratory tests confirm the outstanding corrosion resistance, and tests conducted by independent institutes acknowledge the biological compatibility on the basis of cytotoxicity tests. Please inquire for our certifications. All cast partial denture alloys are free of beryllium, iron, nickel, indium, gallium and copper.

+++ = excellent ++ = very good



Cast partial denture investment materials:
fast, flexible and with a perfect fit.

Flexibility in preheating.

Dentaurum investment materials cover the whole spectrum of the cast partial denture technique. They can be used for conventional preheating, quick preheating and speed preheating.

The perfect fit.

Whatever Dentaurum investment material you choose, you will always achieve excellent results.

Strict final checks.

Prior to filling into the proportioned aluminum foil bags, the quality of the investment material is examined on the basis of dental technical standards according to DIN and ISO.

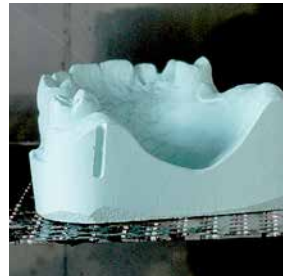

rema® cast partial denture investment materials at a glance.

	rema® blue	rema® dynamic S	rema® Exakt F	rema® Exakt
Characteristics	Modern cast partial denture – investment material with high gas permeability.	Universal, quick model casting investment material.	Fine and exact model casting investment material.	Classical, robust model casting investment material.
Product advantages	<ul style="list-style-type: none"> ■ reduced preheating temperature thanks to good gas permeability ■ very smooth casting surfaces ■ flexibility in preheating stage, conventional and speed heating ■ excellent fit ■ universally suitable in all duplicating procedures 	<ul style="list-style-type: none"> ■ complete flexibility in the preheating stage - speed heating - reduced quick heating from 600 °C / 1112 °F - conventional preheating ■ suitable for combination prosthetics - impressive fit even with complicated structures ■ universally suitable in all duplicating procedures - compatible with duplicating materials silicone and gel ■ excellent fit - knife edge stability and smoothness 	<ul style="list-style-type: none"> ■ improved development of the classic rema® Exakt - the proven recipe was optimized with a finer grain size ■ very easy, pleasant working - pleasant consistency - adequate working time - reduced dust ■ very accurate fit - perfectly fitting castings in all areas ■ especially easy devestment - very soft devestment and light sandblasting 	<ul style="list-style-type: none"> ■ very uncomplicated to process - good results even in extreme laboratory conditions ■ reproducible precision - maintains the same high accuracy from casting to casting ■ especially recommended for gel duplications - quick setting increases the quality with gel duplications ■ universal processing - especially economical due to addition of water
Preheating	<ul style="list-style-type: none"> ■ Speed preheating ■ Consistent preheating 	<ul style="list-style-type: none"> ■ Speed preheating ■ Partial speed preheating ■ Consistent preheating 	<ul style="list-style-type: none"> ■ Consistent preheating ■ Preheating with holding time 	<ul style="list-style-type: none"> ■ Consistent preheating ■ Preheating with holding time
Duplicating gel	+++	+++	+++	+++
Duplicating silicone	+++	+++	+++	+
Mixing consistency	+++	++	+++	+
Model hardness	+++	+++	++	++
Deflasking behavior	+++	++	+++	++
Ordering information				
Powder	REF 105-720-00 16 kg (80 x 200 g)	REF 105-600-50 20 kg (112 x 180 g) REF 105-610-50 20 kg (40 x 500 g) REF 105-610-85 20 kg (8 x 2.5 kg) REF 105-609-50 8 kg (16 x 500 g)	REF 105-020-50 20 kg (50 x 400 g) REF 105-021-50 20 kg (100 x 200 g) REF 105-008-50 8 kg (20 x 400 g)	REF 105-021-00 20 kg (100 x 200 g) REF 105-020-00 20 kg (50 x 400 g) REF 105-020-80 8 kg (8 x 2.5 kg)
Mixing liquid	REF 105-730-00 1 l (Model) REF 105-731-00 1 l (Encasement)	REF 105-620-50 1 l (Standard) REF 105-623-50 1 l (Speed) REF 105-502-00 1 l (Power Liquid)	REF 105-501-00 1 l (Standard) REF 105-502-00 1 l (Power Liquid)	REF 105-501-00 1 l (Standard) REF 105-502-00 1 l (Power Liquid)

+++ = excellent ++ = very good + = good

Duplicating materials.

Flexible, accurate, economical.

Duplicating silicone – the highest precision.

The quick working time and high elasticity guarantee a high level of working comfort.

Duplicating gel – highly economical.

The high standard of quality means the material can be frequently reused and duplicate models made of investment material or plaster can be fabricated accurately.

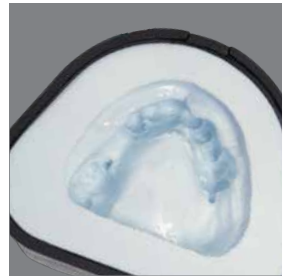

Reversible agar duplicating materials at a glance.

	Dublitolp®	Duplikat	Dubliform	Dubliplast®	DubliGel
Characteristics	Opaque, high-contrast top-quality duplicating gel with properties similar to silicone.	Proven, top-quality transparent precision duplicating gel. Suitable for phosphate and binder investments.	Time-tested quality duplicating gel.	Universal quality duplicating gel for plaster and investment materials.	Specialized duplicating gel for duplicate models in plaster.
Product advantages	<ul style="list-style-type: none"> ■ highly crisp details - optimal contrast due to the light-blue, opaque color ■ exceptional tear resistance - high edge strength during removal ■ excellent fit - optimum duplicating results ■ excellent thermal stability - long shelf-life ensures cost-effectiveness ■ does not color plaster models ■ suitable for microwaves 	<ul style="list-style-type: none"> ■ extreme volumetric stability ■ low viscosity ■ no pulling away from metal ■ quick use by adding water ■ ready to use after initial heating 	<ul style="list-style-type: none"> ■ volumetric stability ■ precise duplicate impressions ■ transparent ■ elastic ■ durable ■ low viscosity 	<ul style="list-style-type: none"> ■ high elasticity and tear resistance ■ models can be easily removed from the duplicating material 	<ul style="list-style-type: none"> ■ very clean duplication with all model plasters
Areas of use					
Cast partial dentures	X	X	X	X	—
Combination technique	X	X	—	—	—
Casting technique with acrylic	X	X	X	X	—
Suitable for duplicate plaster models	—	—	—	X	X
Suitable for cast partial denture investment material	X	X	X	X	—
Technical data					
Color	opaque, light blue	transparent, yellow	transparent, orange	transparent, violet	pink
Typical, repeated melting cycles (at optimal laboratory conditions)	25	20	15	15	12
Product characteristics					
Elasticity and tear resistance	extremely high	very high	high	high	high
Accuracy of reproduced details	very high	very high	high	high	high
Accuracy of fit	extremely high also for attachments	very high also for attachments	high	high	high
Suitable for microwaves	X	X	X* * please observe extra instructions.	X	X
Ordering information					
Availability	REF 108-610-00 Container (5 kg) REF 108-615-00 Packaged portions Micro (4 x 350 g)	REF 108-600-00 Container (6 kg) REF 108-605-00 Concentrate (3.7 kg)	REF 108-500-00 Container (6 kg) REF 108-550-00 Concentrate (2.9 kg)	REF 165-500-00 Container (5 kg) REF 165-550-00 Concentrate (2.7 kg)	REF 165-501-00 Container (5 kg)

Cast partial denture

Alloys



remanium® GM 800+

Extra spring-hard universal alloy with a high yield strength for all types of cast partial denture work.

Advantages:

- fracture resistant due to excellent physical properties
- high modulus of elasticity allows delicate but still rigid constructions
- even less risk of clasp fractures due to increased yield strength
- the right moment for casting is shown when the melt has a mirror-like shine. No overheating of melt results in smooth and clean castings
- high-luster surface after electrolytic polishing
- very good laser welding properties

Indication: cast partial denture and combination technique for rigid constructions with special high firmness

Norm: DIN EN ISO 22674, Type 5

Technical data

0.2% Yield strength $R_{p0.2}$	720 MPa
Tensile strength R_m	960 MPa
Hardness	370 HV 10
Elongation A_5	4 %
Modulus of elasticity E	230 GPa
Density	8.2 g/cm ³
Solidus temperature	1240 °C / 2264 °F
Liquidus temperature	1410 °C / 2570 °F
Weight of casting ingot	6 g

REF 102-200-10	1000 g
----------------	--------

CE 0483

Composition (percentage by mass)

Co	Cr	Mo	W	Si
58.3	32.0	6.5	1.5	1.0

Additional elements < 1 %: C, N

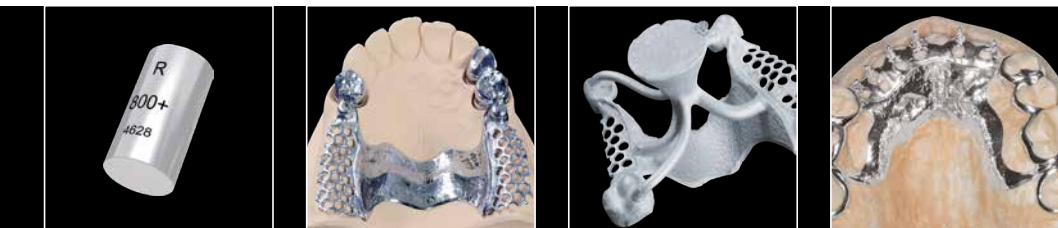

remanium® GM 380+

Time-tested, spring-hard alloy for all types of cast partial denture work.

Advantages:

- further development of the time-tested remanium® GM 380
- the right moment for casting is shown when the melt has a mirror-like shine. No overheating of melt results in smooth and clean castings
- reduced surface hardness
- easy preparation and polishing
- the high elongation at break value promotes activation

Indication: cast partial denture and combination work technique for standard constructions with high firmness

Norm: DIN EN ISO 22674, Type 5

Technical data

0.2% Yield strength $R_{p0.2}$	640 MPa
Tensile strength R_m	900 MPa
Hardness	360 HV 10
Elongation A_5	6.5 %
Modulus of elasticity E	220 GPa
Density	8.2 g/cm ³
Solidus temperature	1300 °C / 2372 °F
Liquidus temperature	1370 °C / 2498 °F
Weight of casting ingot	6 g

REF 102-001-10	1000 g
----------------	--------

CE 0483

Composition (percentage by mass)

Co	Cr	Mo
64.6	29.0	4.5

Additional elements < 1 %: C, Mn, N, Si



Cast partial denture

Alloys



remanium® GM 900

Extra spring-hard, modern alloy for all types of partial denture work. Excellent laser welding properties, as it is carbon free.

Advantages:

- harmoniously matched, high mechanical parameters
- easily trimmed and polished due to the reduced surface hardness
- the right moment for casting is shown when the melt has a mirror-like shine. No overheating of melt results in smooth and clean castings
- patented composition based on CoCrMoTa

Indication: cast partial denture and combination work technique for rigid constructions with special increased firmness

Norm: DIN EN ISO 22674, Type 5

Technical data

0.2% Yield strength $R_{p0.2}$	700 MPa
Tensile strength R_m	910 MPa
Hardness	340 HV 10
Elongation A_5	5 %
Modulus of elasticity E	210 GPa
Density	8.2 g/cm ³
Solidus temperature	1360 °C / 2480 °F
Liquidus temperature	1410 °C / 2570 °F
Weight of casting ingot	6 g

REF 102-250-00

1000 g

CE 0483

Composition (percentage by mass)

Co	Cr	Mo	Si	Ta
62.0	30.0	5.5	1.2	1.2

Additional elements < 1 %: N

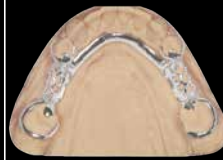
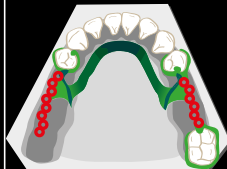

remanium® GM 280

Spring hard alloy with reduced hardness for the cast partial denture technique.

Product advantages:

- the low hardness enables easy finishing and polishing
- high elongation at rupture prevents clasp fractures
- mirror effect indicates the appropriate moment for casting.
Prevents overheating of melt
- very good laser welding properties

Indication: cast partial dentures

Norm: DIN EN ISO 9693, DIN EN ISO 22674

Technical data

0.2% Yield strength $R_{p0.2}$	600 MPa
Tensile strength R_m	845 MPa
Hardness	280 HV 10
Elongation A_5	11 %
Modulus of elasticity E	190 GPa
Density	8.6 g/cm ³
Solidus temperature	1320 °C / 2408 °F
Liquidus temperature	1420 °C / 2588 °F
Weight of casting ingot	6 g

REF 102-280-00	1000 g
----------------	--------

CE 0483

Composition (percentage by mass)

Co	Cr	W	Si
61.0	28.0	8.0	1.5

Additional elements < 1 %: C, Mn, N, Nb

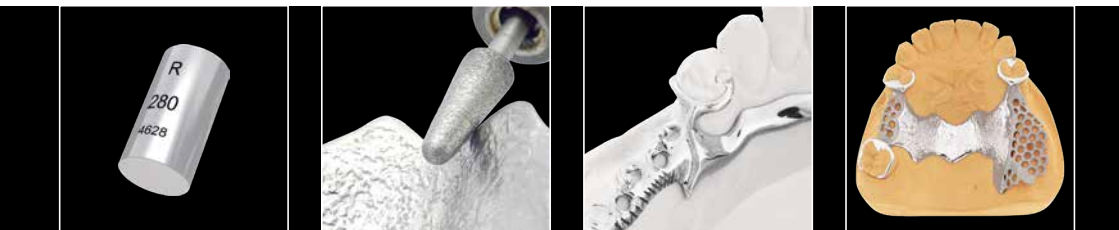

Cast partial denture

Titanium



Tritan

Titanium grade 1

Norm: DIN 17862, DIN EN ISO 22674

min. 99.5 % titanium

Good casting properties in casting machines designed specifically for titanium.

Dentaurum provides, under the brandname Tritan, pure titanium in ingots of different sizes which can be used in the titanium casting machines.

Each ingot is marked with the name Tritan, the purity grade and batch number. Thus, Dentaurum ensures that only DIN Standard Tritan titanium of proper purity grade is used for dental castings.

Advantages:

- minimal oxygen content. Very good castability
- 5 different weight units ensure accurate dispensing
- maximum purity

Indication: crowns and bridges, implant supported supra-structures, cast partial dentures

Height ingot	Weight of casting ingot	REF	Quantity
11.8 mm	18 g	100-100-50	250 g
14.3 mm	22 g	100-101-50	500 g
14.3 mm	31 g	100-102-50	500 g
14.3 mm	36 g	100-103-50	500 g
15.8 mm	40 g	100-105-50	500 g

CE 0483

Technical data

0.2% Yield strength $R_{p0.2}$	460 MPa
Tensile strength R_m	560 MPa
Hardness	200 HV 10
Modulus of elasticity E	110 GPa
Density	4.5 g/cm ³
Melting point	1668 °C / 3034.4 °F
CTE 25–500 °C / 77–932 °F	9.6 x 10 ⁻⁶ K ⁻¹



rematitan® M

Titanium grade 4

Norm: DIN 17862, DIN EN ISO 22674

min. 99.5 % titanium

Dentaurum provides, under the brandname rematitan® M, pure titanium in ingots which can be used in the titanium casting machines. Each ingot is marked with the name rematitan® M, the purity grade and batch number. Thus, Dentaurum ensures that only DIN Standard rematitan® M titanium of proper purity grade is used for dental castings.

Advantages:

- higher figures in elongation, proof stress and elasticity
- maximum purity

Indication: implant supported supra-structures, cast partial dentures



Height ingot	Weight of casting ingot	REF	Quantity
14.3 mm	31 g	100-107-00	1000 g

CE 0483

Technical data

0.2% Yield strength $R_{p0.2}$	600 MPa
Tensile strength R_m	680 MPa
Hardness	210 HV 10
Modulus of elasticity E	120 GPa
Density	4.5 g/cm ³
Melting point	1668 °C / 3034.4 °F



Cast partial denture

Solders and welding wires



CoCrMo-Sold 1

- pure CoCrMo solder, nickel -free
- corrosion-resistant, no discoloration
- flows easily
- without flux

Area of application:

- all CoCr bonding alloys for presoldering
- all CoCr cast partial denture alloys

Recommended Flux: rema® Flux 1, REF 102-304-00

Solidus temperature	1110 °C / 2030 °F
Liquidus temperature	1162 °C / 2123.6 °F

REF 102-306-00	3 g
----------------	-----

CE 0483

Composition (percentage by mass)

Co	Cr	Mo	Si	B
69.8	19.0	5.0	5.0	1.2

without flux



Soldering rod for chrome-cobalt

- incl. flux
- no discoloration

Area of application:

- all CoCr cast partial denture alloys

Liquidus temperature	1100 °C / 2012 °F
----------------------	-------------------

REF 142-100-50	6 rods
----------------	--------

CE 0483

Composition (percentage by mass)

Co	Cr	Ni	Si	W
50.0	18.0	17.0	8.0	4.0



White gold solder

- in rods
- ready fluxed
- purity: ct 18.6
- cadmium free

Not permitted for intra-oral use.

ø	1–1.1 mm
Working temperature	950 °C / 1742 °F

REF 380-600-50	1.6 g
----------------	-------

Composition (percentage by mass)

Au	Ni	Zn
77.0	16.0	6.0

with flux



Universal silver solder

- in rods
- ready fluxed
- cadmium free

Not permitted for intra-oral use.

ø	1–1.1 mm
Working temperature	700 °C / 1292 °F

REF 380-604-50	1.2 g
----------------	-------

REF 380-604-60	10 x 1.2 g
----------------	------------

Composition (percentage by mass)

Ag	Zn	Cu
59.0	24.0	16.0

with flux



Universal silver solder

- in coils
- without flux
- cadmium free

Not permitted for intra-oral use.

Working temperature	700 °C / 1292 °F
---------------------	------------------

REF 380-704-50	10 g
----------------	------

Composition (percentage by mass)

Ag	Zn	Cu
59.0	25.0	16.0

without flux

rema® Flux 1

- flux for CoCrMo-Sold 1 and NiCr-Sold 1
- excellent wetting of alloys
- guarantees good flowability of the solder

REF 102-304-00	25 g
----------------	------



Dentaflux® flux

- universal flux
- for all alloys
- especially for connections between precious and non-precious alloys

REF 681-100-00	50 g
----------------	------



Heat protection

Protects metal, plastic and ceramic parts against heat damage during soldering.

REF 380-070-00	100 g
----------------	-------



CoCr welding wire

Various dimensions to be used as a filling soldering wire for all CoCr alloys.

ø	Length	REF	Quantity
0.25 mm / 10	2 m	528-215-10	1 piece
0.35 mm / 14	2 m	528-210-10	1 piece
0.50 mm / 20	2 m	528-200-10	1 piece



CE 0483

Composition (percentage by mass)

Co	Cr	Mo
65.0	28.0	5.5

Additional elements < 1 %: Mn, Si



DENTALURUM
ONLINE SHOP
shop.dentalurum.com



Cast partial denture

Investment materials



rema® blue

Model casting investment material.

Advantages:

- reduced preheating temperature thanks to good gas permeability
- very smooth casting surfaces
- flexibility in preheating stage, conventional and speed heating
- excellent fit
- universally suitable in all duplicating procedures

Norm: DIN EN ISO 15912

Type 2

Class 1

Working time	3–4 min
Preheating	consistent preheating, speed preheating
Preheating temperature	850-900 °C / 1562-1652 °F
Compression resistance	12 MPa
Color	blue

REF 105-720-00 16 kg (80 x 200 g)



rema® blue mixing liquid for model

Approx. 2600 ml mixing liquid is required for 16 kg investment material.

Caution: Mixing liquid is sensitive to frost!
Please order prior to frost season.

REF 105-730-00 1 l



rema® blue mixing liquid for encasement

Used for encasement for speed casting.
Approx. 2600 ml mixing liquid is required for 16 kg investment material.

Caution: Mixing liquid is sensitive to frost!
Please order prior to frost season.

REF 105-731-00 1 l

rema® dynamic S

Universal, quick model casting investment material.

Advantages:

- complete flexibility in the preheating stage
 - speed preheating
 - partial speed preheating from 600 °C / 1112 °F
 - conventional preheating
- suitable for combination prosthetics
 - impressive accuracy even with complicated structures
- universally suitable in all duplicating procedures
 - compatible with duplicating materials silicone and gel
- excellent accuracy
 - knife-edge stability and smoothness

Norm: DIN EN ISO 15912

Type 2

Class 1, 2

Working time	3–4 min
Preheating	consistent preheating, partial speed preheating, speed preheating
Preheating temperature	900–950 °C / 1652–1742 °F
Compression resistance	12 MPa
Color	green

REF 105-600-50	20 kg (112 x 180 g)
REF 105-610-50	20 kg (40 x 500 g)
REF 105-610-85	20 kg (8 x 2.5 kg)
REF 105-609-50	8 kg (16 x 500 g)



rema® dynamic S mixing liquid

Approx. 3000 ml mixing liquid are sufficient for 20 kg investment material.

Caution: Mixing liquid is sensitive to frost!

Please order prior to frost season.

REF 105-620-50	1 l
----------------	-----



rema® dynamic S mixing liquid Speed

To be used for speed preheating.

Approx. 3000 ml mixing liquid are sufficient for 20 kg investment material.

Caution: Mixing liquid is sensitive to frost!

Please order prior to frost season.

REF 105-623-50	1 l
----------------	-----



Cast partial denture

Investment materials



rema® Exakt F

Fine and exact model casting investment material.

Advantages:

- improved development of the classic rema® Exakt
 - the well-proven recipe was optimized with a finer grain size
- very easy, pleasant working
 - fine consistency
 - adequate working time
 - reduced dust
- very high accuracy
 - perfectly fitting castings in all areas
- especially easy devestment
 - very soft devestment and light sand blasting

Norm: DIN EN ISO 15912

Type 2

Class 1

Working time	3–4 min
Preheating	consistent preheating, preheating with holding time
Preheating temperature	950–1000 °C / 1742–1832 °F
Compression resistance	10–14 MPa
Color	pink

REF 105-020-50	20 kg (50 x 400 g)
REF 105-021-50	20 kg (100 x 200 g)
REF 105-008-50	8 kg (20 x 400 g)



rema® Exakt, rema® Exakt F mixing liquid

Approx. 3000 ml mixing liquid are sufficient for 20 kg investment material.

Caution: Mixing liquid is sensitive to frost!
Please order prior to frost season.

REF 105-501-00	1 l
----------------	-----

rema® Exakt

Classical, robust, model casting investment material.

Advantages:

- very uncomplicated operation
 - good results even in extreme laboratory conditions
- reproducible precision
 - maintains the same high accuracy from casting to casting
- especially recommended for gel duplications
 - quick setting increases the quality with gel duplications
- universal procedure
 - especially economical due to addition of water

Norm: DIN EN ISO 15912

Type 2

Class 1

Working time	3–4 min
Preheating	consistent preheating, preheating with holding time
Preheating temperature	950–1000 °C / 1742–1832 °F
Compression resistance	12–15 MPa
Color	pink

REF 105-021-00	20 kg (100 x 200 g)
REF 105-020-00	20 kg (50 x 400 g)
REF 105-020-80	20 kg (8 x 2.5 kg)



rema® Exakt, rema® Exakt F mixing liquid

Approx. 3000 ml mixing liquid are sufficient for 20 kg investment material.

Caution: Mixing liquid is sensitive to frost!

Please order prior to frost season.

REF 105-501-00	1 l
----------------	-----



Cast partial denture

Investment materials



Special tooth-arch concentrate

For the one-piece casting technique.

Caution: Mixing liquid is sensitive to frost!
Please order prior to frost season.

REF 105-621-00

250 ml



Power Liquid mixing liquid, concentrate

For rema® Exakt, rema® Exakt F, rema® dynamic S, rema® blue, Castorit®-super C and Trivest.

- reduces transport costs
- expansion can be individually adjusted

Approx. 2000 ml mixing liquid are sufficient for 20 kg investment material.

Approx. 800 ml mixing liquid are sufficient for 6 kg investment material.

Caution: Mixing liquid is sensitive to frost!
Please order prior to frost season.

REF 105-502-00

1 l

rematitan® Plus

Universal titanium investment for all areas.

Advantages:

- suitable for use both in cast partial denture work and the entire range of crown and bridge work
- expansion is controlled using 2 mixing liquids (cast partial dentures and crowns and bridges)
- prevents the reaction of mould material and molten titanium to a high degree
- use of pure refractory materials

Norm: DIN EN ISO 15912

Type 1, 2

Class 1

Working time	3–4 min
Preheating	preheating with holding time
Preheating temperature	1000 °C / 1832 °F
Compression resistance	5–8 MPa
Color	white

REF 107-600-00	20 kg (80 x 250 g)
REF 107-610-00	8 kg (32 x 250 g)



rematitan® Plus mixing liquid for framework casting

Approx. 3200 ml mixing liquid are sufficient for 20 kg investment material.

Caution: Mixing liquid is sensitive to frost!
Please order prior to frost season.

REF 107-601-00	1 l
----------------	-----



rematitan® Plus mixing liquid for crowns and bridges

Approx. 3200 ml mixing liquid are sufficient for 20 kg investment material.

Caution: Mixing liquid is sensitive to frost!
Please order prior to frost season.

REF 107-602-00	1 l
----------------	-----



rematitan® cold model hardener

For hardening rematitan® Plus investment models.

- straightforward handling
- environment friendly product
- for hard, sharp-edged rematitan® Plus refractory models
- improved adhesion of wax profiles

REF 167-305-00	1 l
----------------	-----



Cast partial denture

Fine investment materials



RK-DUR fine investment

By means of metal oxide in the RK-DUR fine investment, the liquid melt is stimulated to increase the grain formation in the solidification phase. Improves the mechanical properties of CoCrMo alloys.

- RK-DUR improves proof stress, tensile strength and elongation at break
- no vacuum investing needed for casting ring
- durable, hard ceramic coating
- produces smooth casting surfaces
- easy application
- easy deinvesting
- long shelf life

Color: blue

REF 104-400-50

150 g



RK 3 fine investment

For coating wax and plastic patterns when using phosphate-based investments, e. g. rema® Exakt. Not suitable for ethyl silicate investments. Ready-to-use.

- no vacuum investing needed for casting ring
- durable, hard ceramic coating
- produces smooth casting surfaces
- easy to agitate
- easy application
- easy deinvesting
- long shelf life

Color: blue

REF 104-501-50

150 g

Dublitolp®

Opaque, high-contrast top-quality duplicating gel with properties similar to silicone.

- highly crisp details
 - optimal contrasts due to the light blue, opaque color
- exceptional tear resistance
 - high edge strength during removal
- excellent fit
 - optimum duplicating results
 - excellent thermal stability
 - long shelf life ensures cost-effectiveness
- does not color plaster models
- biodegradable
- smooth surfaces
- suitable for microwaves
- can be melted up to 25 times

Area of application:

- cast partial dentures
- fixed/removable restorations
- acrylic pouring technique

Color: opaque, light blue

REF 108-610-00	5 kg
----------------	------



Dublitolp® micro

Opaque, high-contrast top-quality duplicating gel with properties similar to silicone.

Innovative small portions:

Duplicating gel for use in microwaves

- can be used very quickly
- easy handling
- minimal technical requirements
- cost saving, can be re-melted up to 25 times

Specifically for laboratories that only require small amounts of duplicating material. Dublitolp® micro is easily melted in a microwave and cools to working temperature in a very short period. Dublitolp® micro is impressive as it reproduces details with absolute dimensional stability, has a long shelf life and is a natural, biodegradable product.

Area of application:

- cast partial dentures
- fixed/removable restorations
- acrylic pouring technique

Color: opaque, light blue

REF 108-615-00	4 x 350 g
----------------	-----------



Cast partial denture

Duplicating materials



Dubliform

Time-tested quality duplicating gel.

- volumetric stability
- precise duplicate impressions
- transparent
- elastic
- durable
- low viscosity
- can be melted up to 15 times

Area of application:

- cast partial dentures
- acrylic pouring technique

Color: transparent, orange

REF 108-500-00

6 kg



Dubliform liquid concentrate

Time-tested quality duplicating gel.

- easy processing by only mixing with water
- ready to use after first heat up
- mixing ratio: 1 l gel : 1 l water
- produces 5.4 kg ready-to-use duplicating gel

Area of application:

- cast partial dentures
- acrylic pouring technique

Color: transparent, orange

REF 108-550-00

2.9 kg

Duplikat

Proven top-quality transparent precision duplicating gel.
Suitable for phosphate-based and ethyl silicate investments.

- no shrinkage at metal primary parts
- outstanding fit
- smooth metal surfaces
- long shelf life
- can be melted up to 20 times

Area of application:

- cast partial dentures
- fixed/removable restorations
- acrylic pouring technique

Color: transparent, yellow

REF 108-600-00

6 kg



Duplikat liquid concentrate

Proven top-quality transparent precision duplicating gel.
Suitable for phosphate-based and ethyl silicate investments.

- extreme volumetric stability
- low viscosity
- no pulling away from metal
- quick use by adding water
- ready to use after initial heating
- mixing ratio: 1 l gel : 0.5 l water
- produces 5.2 kg ready-to-use duplicating gel

Area of application:

- cast partial dentures
- fixed/removable restorations
- acrylic pouring technique

Color: transparent, yellow

REF 108-605-00

3.7 kg



Cast partial denture

Duplicating materials



Dubliplast®

Universal quality duplicating gel for dental stone and investments.

- high elasticity and tear resistance
- models can be easily removed from the duplicating material
- can be melted up to 15 times

Area of application:

- cast partial dentures
- acrylic pouring technique
- dental stone duplication

Color: transparent, violet

REF 165-500-00

5 kg



Dubliplast® liquid concentrate

Universal quality duplicating gel for dental stone and investments.

- easy processing by only mixing with water
- ready to use after first heat up
- mixing ratio: 1 l gel : 1 l water
- produces 5.2 kg ready-to-use duplicating gel

Area of application:

- cast partial dentures
- acrylic pouring technique
- dental stone duplication

Color: transparent, violet

REF 165-550-00

2.7 kg



DubliGel

Specialized duplicating material for secondary model in plaster.

- very clean duplication with all model plasters

Area of application:

- dental stone duplication

Color: pink

REF 165-501-00

5 kg

rema® Sil

Additional cross-linked pure silicone for a high standard of quality.

- pure silicone without fillers
 - large quantity 950 ml and 1 kg
 - long storage time
- low level of hardness
 - high degree of accuracy due to free investment expansion
- extremely thin flowing consistency
 - bubble-free impression of detailed structures
- very quick setting time and fast elastic recovery
 - great time saver



Component	Color	REF	Quantity	REF	Quantity
A (catalyst)	white	108-700-00	1 kg	108-710-00	5 kg
B	blue	108-701-00	1 kg	108-711-00	5 kg

Technical data	A (catalyst)	B
Mixing ratio	1 : 1	
Viscosity	1400 mPas	
Density	1060 g/l	1070 g/l
Working time	4-5 min	
Setting time	12 min	
Shore hardness A	10-12	
Elastic memory	99.9 %	

ecosil +

Additional cross-linked two component silicone.

- good color contrast
 - green color prevents mixing errors
- extremely thin flowing consistency
 - highly accurate duplicate reproduction
- long working time
 - can be used to re-cast models many times
- medium Shore hardness A (19)
 - use also with ring-free duplicating systems



Component	Color	REF	Quantity	REF	Quantity
A (catalyst)	yellow	108-703-10	1 kg	108-705-10	5 kg
B	blue	108-704-10	1 kg	108-706-10	5 kg

Technical data	A (catalyst)	B
Mixing ratio	1 : 1	
Viscosity	2000 mPas	
Density	1160 g/l	
Working time	6-8 min	
Setting time	30 min	
Shore hardness A	18-20	
Elastic memory	99.9 %	

Cast partial denture

Duplicating materials – accessories



Tap

For 5 kg canister.

REF 108-716-00

1 piece



Duplicating flask

Quick, regulated setting of duplicating material with all duplicating gels.

- corrosion resistant metal flask
- support for individual positioning of sprue former
- two bases for large and small models
- sprue former with metal pin (REF 127-312-00).
Fixation is made by means of holding device

REF 165-700-00

1 piece



Sprue former with retention

REF 127-311-00

1 piece



Sprue former

Made from plastic with slide tube for insertion in the duplicating material.

- reliable, firm retention

REF 127-312-00

1 piece



Casting sprue former titanium

Application for rematitan[®]/autocast casting machines.
Material: Plastic

REF 090-027-00

5 pieces

Siliform duplicating flask

Plastic flask for silicone and reversible duplicating materials.

With the 3 flasks of different heights, various model sizes can be duplicated economically.

Up to 30 % savings



Size	Internal height of flask top	Color	REF	Quantity
small	35 mm	clear	127-315-00	1 piece
medium	43 mm	clear	127-316-00	1 piece
large	51 mm	clear	127-317-00	1 piece

rema® Form base, smooth

Fits all Dentaaurum duplicating flasks and casting rings (small, medium, large).

REF 127-309-00	1 piece
-----------------------	---------



Siliform-Set

Plastic flasks for silicone and reversible duplicating materials.

With the 3 flasks of different heights, various model sizes can be duplicated economically.

Up to 30 % savings

Internal height of flask top:

small 35 mm

medium 43 mm

large 51 mm

Bases fit all top units.

REF 127-318-00	1 set
-----------------------	-------

Contents:

1 x Siliform duplicating flask, small	REF 127-315-00
1 x Siliform duplicating flask, medium	REF 127-316-00
1 x Siliform duplicating flask, large	REF 127-317-00
3 x rema® Form base, smooth	REF 127-309-00



Gumex N

Wax-based putty for covering undercut areas on stone models prior to duplication.

- soft, easy to adapt
- no discoloration
- easy removal from model after duplication
- multiple reuse
- good adaptation onto the model

Color: yellow

REF 168-015-50	650 g
-----------------------	-------



Cast partial denture

Duplicating materials – accessories



Neo-Star flask

Duplicating flask for silicone – multifunctional for the cast partial denture technique. Suitable for all model sizes.

Function:

- saves duplicating silicone due to height adjustment
- plaster models are articulated using magnets
- the investment model may be replaced accurately into the articulator
- investment system

REF 165-810-00	1 set
Contents:	
1 x Flask bottom section	REF 165-850-00
1 x Base form for gypsum	REF 165-851-00
1 x Base form for investment material	REF 165-858-00
1 x Covering plate	REF 165-852-00
1 x Spacer ring 0.7 mm	REF 165-855-00
1 x Spacer ring 0.8 mm	REF 165-856-00
1 x Spacer ring 0.9 mm	REF 165-857-00
1 x Collar	REF 165-853-00
1 x Top	REF 165-854-00
1 x Magnet	REF 165-839-00
1 x Tightening slide	REF 165-860-00

Neo-Star individual flask components



Designation	REF	Quantity
Flask bottom section, Inner ø 78 mm	165-850-00	1 piece
Base form for gypsum	165-851-00	1 piece
Base form for investment material	165-858-00	1 piece
Covering plate	165-852-00	1 piece
Collar	165-853-00	1 piece
Top	165-854-00	1 piece
Magnet	165-839-00	1 piece
Tightening slide	165-860-00	1 piece

Septisol

Separating agent with dual function, alcohol-free.

- **Plaster against silicone**

Spray on plaster models prior to silicone duplication.

- **Plaster against plaster**

Spray on plaster model base before mounting in articulator.

REF 108-720-50	100 ml
REF 108-721-50	1 l



Lubrofilm®

Double function

- **Silicone surface tension reducing agent**

Allows bubble-free pouring of investment into silicone mould.

- **Wax surface tension reducing agent**

Reduces surface tension on wax and facilitates investing.

REF 112-050-00	100 ml
REF 112-051-00	1 l



Remadur

Solvent-free cold model hardener for investment models.

- solvent-free
- environmentally friendly
- low viscosity
- no heating of the hardener



REF 167-301-00	1 l
----------------	-----



Cold model hardener

Cold model hardener containing solvent for investment models.

- no heating of the hardener
- low viscosity
- very hard models with a high edge strength

Recommended working container: cleaned duplicating tube with cover.



REF 167-215-00	2.3 kg
----------------	--------



Cast partial denture

Waxes

Preformed clasps

- excellent adaptability
- outstanding adhesion
- burn out residue-free

Color: green

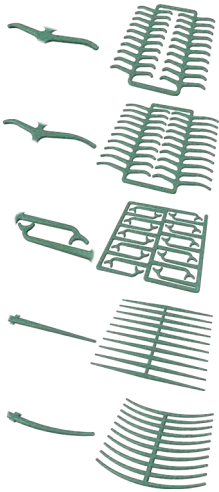

Designation	Abbreviation	REF	Quantity
Premolar clasps	PK	110-001-00	200 pieces
Molar clasps	MK	110-002-00	200 pieces
Bonyhard clasps	TK 1	110-003-00	200 pieces
Ring clasps, straight	RKG	110-013-00	200 pieces
Ring clasps, curved	RK	110-005-00	200 pieces



Wax retention

- wide range of different shapes
- excellent adaptability
- outstanding adhesion
- burn out residue-free

Color: red

Designation	Abreviation	REF	Quantity
Grid, coarse	RN I	110-101-00	20 pieces
Grid, fine	RN II	110-102-00	20 pieces
Grid, round	RN III	110-103-00	20 pieces
Ridge retention	KR	110-006-00	80 pieces
Loop retention, small	PR I	110-011-00	24 pieces
Loop retention, large	PR II	110-012-00	24 pieces
Perforated retention for lower staggered, length 130 mm, width 7 mm	LR	111-216-00	25 pieces
Perforated retention for lower staggered, length 110 mm, width 9 mm	LR I	111-217-00	25 pieces
Perforated retention for lower straight, length 125 mm, width 6 mm	LR II	111-218-00	25 pieces

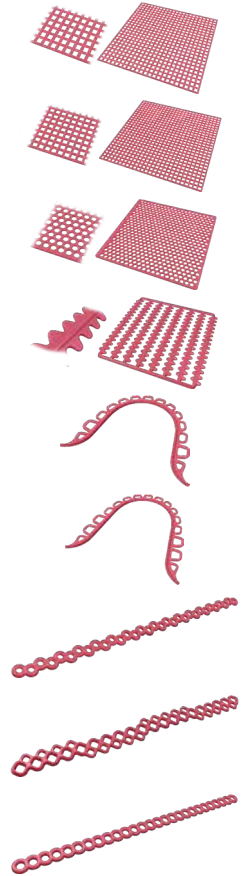

Cast partial denture

Waxes



Wax wire on roll

- for sprues
- two qualities of wax
- smooth surfaces
- easy waxing due to fast solidification
- rigid and stress-free after application

∅	Soft-Quality REF (blue)	Standard-Quality REF (violet)	Quantity
2.0 mm	111-720-00		250 g
2.5 mm	111-825-00	111-425-00	250 g
3.0 mm	111-830-00	111-430-00	250 g
3.5 mm	111-835-00	111-435-00	250 g
4.0 mm	111-840-00	111-440-00	250 g
5.0 mm	111-850-00	111-450-00	250 g



Wax wire rod

- for retentions etc.
- easily adaptable

∅	Color	REF	Quantity
● 0.6 mm	blue	111-106-00	12 g
● 0.8 mm	blue	111-108-00	25 g
● 0.9 mm	green	111-109-00	25 g
● 1.0 mm	green	111-110-00	25 g
● 1.2 mm	green	111-112-00	37 g
● 1.5 mm	green	111-115-00	50 g
● 2.0 mm	blue	111-120-00	50 g

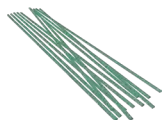

Preformed wax bar, half-round

- used for strengtheners
- easily adaptable

∅	Color	REF	Quantity
◐ 1.5 x 0.75 mm	green	111-301-00	25 g
◐ 1.8 x 0.9 mm	green	111-303-00	50 g
◐ 2.0 x 1.0 mm	green	111-304-00	50 g
◐ 3.5 x 1.75 mm	green	111-306-00	65 g



Preformed wax bar, lingual bar

- easily adaptable

∅	Color	REF	Quantity
◑ 4.0 x 2.0 mm	green	111-314-00	65 g
◑ 4.0 x 1.7 mm	green	111-308-00	65 g
◑ 4.3 x 2.3 mm	green	111-313-00	65 g

Preformed wax bar, sprue strips

- easily adaptable

Width x Thickness	Color	REF	Quantity
8.0 x 1.8 mm	green	111-311-00	65 g



Preformed wax bar, finishing lines

- easily adaptable

Width x Thickness	Color	REF	Quantity
2.0 x 1.0 mm	blue	111-312-00	25 g



Preparation wax

- adhesive
 - Application: relinable saddles
 - soft and transparent
- Dimensions (L x W): 100 x 100 mm

Thickness	Color	REF	Quantity
0.3 mm	transparent	120-023-00	32 sheets
0.4 mm	transparent	120-024-00	32 sheets
0.5 mm	transparent	120-025-00	32 sheets
0.65 mm	transparent	120-026-00	32 sheets
0.75 mm	transparent	120-027-00	32 sheets



Relining wax

- Application: relinable saddles
 - soft and transparent
- Dimensions (L x W): 150 x 70 mm

Thickness	Color	REF	Quantity
0.4 mm	red	120-104-00	15 sheets
0.5 mm	red	120-105-00	15 sheets
0.6 mm	red	120-106-00	15 sheets
0.7 mm	red	120-107-00	15 sheets



Waxes

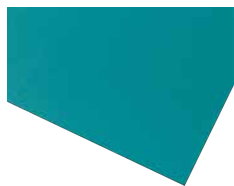

Wax sheet

Surface: plain

- very adaptable quality
- excellent adaptation and adhesion behavior

Dimensions (L x W): 150 x 70 mm

Thickness	Color	REF	Quantity
0.2 mm	green	114-420-00	15 sheets
0.25 mm	green	114-425-00	15 sheets
0.3 mm	green	114-430-00	15 sheets
0.35 mm	green	114-435-00	15 sheets
0.4 mm	green	114-440-00	15 sheets
0.5 mm	green	114-450-00	15 sheets
0.6 mm	green	114-460-00	15 sheets
0.7 mm	green	114-470-00	15 sheets
0.8 mm	green	114-480-00	15 sheets
1.0 mm	green	114-500-00	15 sheets

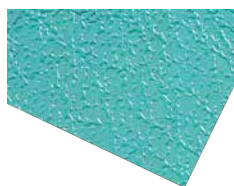

Wax sheet

Surface: fine veined

- the stronger vein and stripled design gives the upper denture a more natural surface structure
- very adaptable quality
- excellent adaptation and adhesion behavior

Dimensions (L x W): 150 x 70 mm

Thickness	Color	REF	Quantity
0.35 mm	green	117-035-00	15 sheets
0.4 mm	green	117-040-00	15 sheets
0.45 mm	green	117-045-00	15 sheets
0.5 mm	green	117-050-00	15 sheets
0.6 mm	green	117-060-00	15 sheets

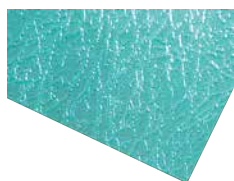

Wax sheet

Surface: medium veined

- the stronger vein and stripled design gives the upper denture a more natural surface structure
- very adaptable quality
- excellent adaptation and adhesion behavior

Dimensions (L x W): 150 x 70 mm

Thickness	Color	REF	Quantity
0.3 mm	green	117-130-00	15 sheets
0.35 mm	green	117-135-00	15 sheets
0.4 mm	green	117-140-00	15 sheets
0.45 mm	green	117-145-00	15 sheets
0.5 mm	green	117-150-00	15 sheets
0.6 mm	green	117-160-00	15 sheets

Wax sheet

Surface: coarse veined

- the stronger vein and strippled design gives the upper denture a more natural surface structure
- very adaptable quality
- excellent adaptation and adhesion behavior

Dimensions (L x W): 150 x 70 mm

Thickness	Color	REF	Quantity
0.35 mm	green	117-235-00	15 sheets
0.4 mm	green	117-240-00	15 sheets
0.45 mm	green	117-245-00	15 sheets
0.5 mm	green	117-250-00	15 sheets
0.6 mm	green	117-260-00	15 sheets

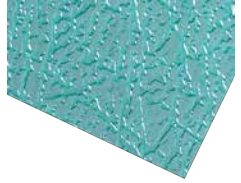

Wax sheet

Surface: coarse grained

- the stronger vein and strippled design gives the upper denture a more natural surface structure
- very adaptable quality
- excellent adaptation and adhesion behavior

Dimensions (L x W): 150 x 70 mm

Thickness	Color	REF	Quantity
0.4 mm	green	118-040-00	15 sheets
0.45 mm	green	118-045-00	15 sheets
0.5 mm	green	118-050-00	15 sheets
0.6 mm	green	118-060-00	15 sheets

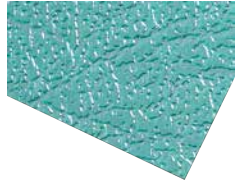

Joining wax

- for joining prefabricated components in cast partial denture work
- no tendency to smear due to similar hardness as the wax pattern

Melting point	Color	REF	Quantity
74 °C / 165.2 °F	violet	110-301-00	50 g

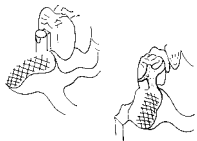

Blocking-out wax

- for blocking-out in cast partial denture work
- good sculpting properties
- high opacity
- outstanding temperature-resistance

Color	REF	Quantity
pink	110-310-00	50 g



Cast partial denture

Accessories



Marking pencil

Wax pencil

Color: white

REF 043-700-00

6 pieces



Wax-Fix

Adhesive for wax- and plastic patterns.

- adheres 100 % to the model

Application:

- surface of investment materials wet, dry or hardened
- plastic surfaces. Moving of adapted parts is possible

REF 110-210-00

50 ml



Adhesive for plastic patterns

For reliable retention with plastic patterns on the investment model.

REF 125-140-00

40 g

Plastic patterns – preformed clasps

- easy application
- transparent
- form stable
- burn out residue-free

Color: green

Designation		REF	Quantity
Single arm clasp	G 1	125-250-50	10 sheets
Ring clasp	G 2	125-251-50	10 sheets
Continuous clasp, small	R 1 S	125-252-50	10 sheets
Double arm clasp with rest, medium	GR 2	125-256-50	10 sheets
Molar clasp	G 3	125-257-50	10 sheets
Double arm clasp small – large	G 4	125-258-50	10 sheets
Double arm clasp small – large, thin	G 4 S	125-259-50	10 sheets
Bonyhard clasp	G 5	125-260-50	10 sheets
Long arm clasps	G 6	125-261-50	10 sheets

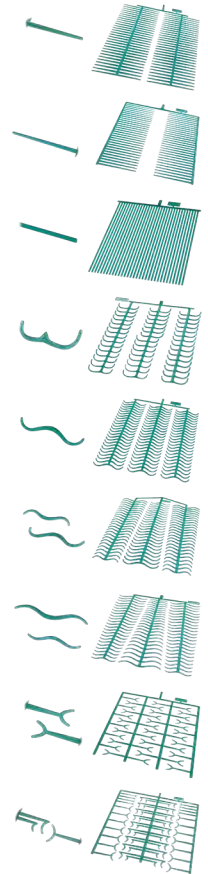

Accessories

Plastic patterns – bars

- easy application
- transparent
- form stable
- burn out residue-free

Color: green

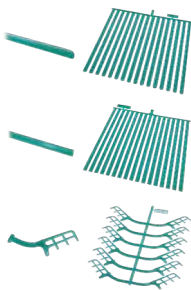

Designation		REF	Quantity
Lingual bar	1 B 1	125-264-50	10 sheets
Lingual bar, narrow	1 B 2	125-265-50	10 sheets
Lingual bar with retentions	BR 2	125-269-50	10 sheets

Plastic patterns – retentions

- easy application
- transparent
- form stable
- burn out residue-free

Color: green

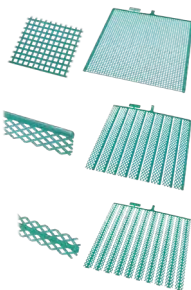

Designation		REF	Quantity
Mesh retentions	RT 1	125-270-50	10 sheets
Mesh retentions with finishing line, upper jaw	CR 1	125-272-50	10 sheets
Mesh retentions with finishing line, lower jaw	CR 2	125-273-50	10 sheets

Plastic patterns – sheets

- easy application
- transparent
- form stable
- burn out residue-free

Color: green

Designation		REF	Quantity
0.5 mm, fine grained	24 S	125-275-50	10 sheets
0.4 mm, fine grained	26 S	125-276-50	10 sheets
0.4 mm, coarse grained	26	125-280-50	10 sheets

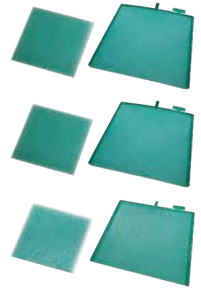

Plastic retentions

- for direct application to waxing model
- burn out residue-free

Color	REF	Quantity
white	126-221-00	500 pieces
white	126-222-00	500 pieces
white	126-226-00	500 pieces
white	126-231-00	500 pieces
white	126-232-00	500 pieces



REF 126-232-00 retention pins, mixed, large and small

Cast partial denture

Accessories



rema® Form casting ring

Quick investment system made from impact-resistant plastic.

Size	ø	Height	Color	REF	Quantity
small	71/96 mm	54.5 mm	green	127-306-00	1 piece
medium	80.5/96 mm	54.5 mm	red	127-307-00	1 piece
large	78/96 mm	70 mm	blue	127-308-00	1 piece



rema® Form base, smooth

Fits all Dentaurem duplicating flasks and casting rings (small, medium, large).

REF 127-309-00	1 piece
-----------------------	---------



rema® Form base with cone

Fits all Dentaurem duplicating flasks and casting rings (small, medium, large).

REF 127-310-00	1 piece
-----------------------	---------



Sprue former with retention

REF 127-311-00	1 piece
-----------------------	---------



Sprue former

Made from plastic with slide tube for insertion in the duplicating material.

- reliable, firm retention

REF 127-312-00	1 piece
-----------------------	---------

Adhesive coated strip for rings

- self-adhesive after moistening
- Dimensions (L x W): 300 x 80 mm

REF 127-100-00	100 sheets
----------------	------------



Lining paper

- corrugated paper
 - continuous roll
- Width: 100 mm

REF 127-010-00	25 m
----------------	------



Sprue

Residue-free burn out plastic for casting from the top.

REF 110-201-00	100 pieces
----------------	------------



Model and casting ring tongs

- angled jaws give more secure grip for refractory models and casting rings (Sizes 1/3/6)
- stainless

Length: 36.0 cm

REF 127-410-00	1 piece
----------------	---------



Casting ring tongs

- for large and small casting rings
- stainless

Length: 56.0 cm

REF 127-400-00	1 piece
----------------	---------



Cast partial denture

Accessories



Rapidur®

Synthetic dental stone

- extra hard, low expansion
- quick-setting

Application:

orthodontics, cast partial denture work,

precious metal, acrylics, ceramics

Norm: DIN EN ISO 6873

Class 4

Mixing ratio (g : ml)	100 : 24
Setting expansion	max. 0.15 %
Working time	min. 3 min
Compression resistance	min. 35 MPa
Setting time	max. 30 min
Color	white

REF 164-450-00

6 kg



Mixing bowl

For plaster, impression and investment materials, easy to clean.

Capacity	REF	Quantity
600 ml	164-650-00	1 piece
400 ml	164-651-00	1 piece



Electropolishing solution

For CoCr castings.

- produces a brilliant surface finish
- deep acting, does not leave streaks

REF 128-301-00

1 l

REF 128-401-00

10 l



Measuring beaker universal

Measuring range in 1 ml steps.

Capacity: 60 ml

REF 105-995-00

1 piece



Separating and grinding discs	Page	250
Grinding points	Page	253
Burs and cutters	Page	255
Diamond burs	Page	259
Mandrels	Page	264
Polishing tools and accessories	Page	265
rematitan® finishing kit	Page	272



Finishing.

Coordinated product range.



DENTAURUM
**ONLINE
SHOP**
shop.dentaurum.com



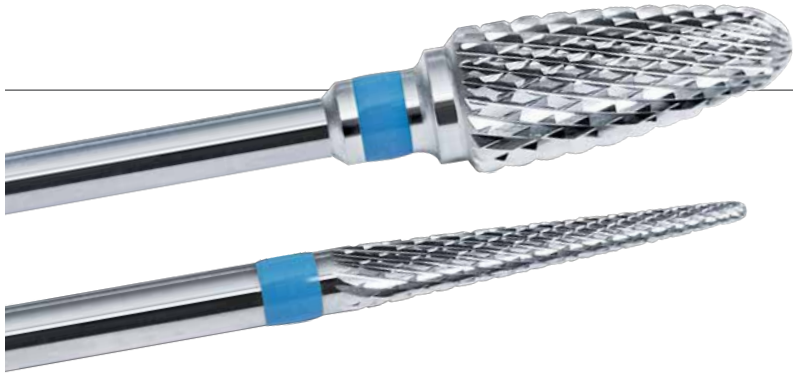

The right cut all around.

Each individual material requires its own special instruments in order to be handled with care. A great variety of diverse instruments such as ceramic bonded burs, tungsten carbide and diamond sintered burs all contribute to economical working procedures.

Finishing and polishing made easy.

Even hard and difficult materials can be easily polished with the correct instruments. Special, individual polishing pastes play an important role.

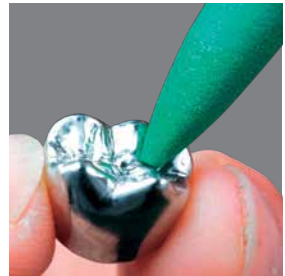

Supercut separating discs

Maximum cutting efficiency, minimal breakage risk.

Grinding points

Ceramic-bonded grinding points.

Super hard metal burs

Tungsten carbide, precision cut.

Diasint

Sintered diamond burs.

Rubber polisher

High abrasive performance from coarse to fine.

Polishing brushes

From linen to steel.

Polishing pastes

For quick, high shine.

Separating and grinding discs

Supercut ST separating disc

- maximum cutting efficiency
- minimal breakage risk
- excellent strength
- nylon reinforced quality

Color: brown

Recommended speed: 15000 min⁻¹

Maximum speed: 35000 min⁻¹



Thickness	ø	REF	Quantity	REF	Quantity
0.50 mm	40 mm	130-102-00	10 pieces	130-102-40	40 pieces
0.70 mm	40 mm	130-103-00	10 pieces	130-103-40	40 pieces
1.00 mm	40 mm	130-101-00	10 pieces	130-101-40	40 pieces



Supercut separating disc for ceramics

- diamond-coated
- very thin with a thickness of 0.25 mm
- double fibre reinforced
- very flexible
- high durability

Application: ceramics

Color: brown

Recommended speed: 15000 min⁻¹

Maximum speed: 35000 min⁻¹

Thickness	ø	REF	Quantity
0.25 mm	20 mm	130-115-00	10 pieces

Supercut STM separating disc

- maximum cutting efficiency
- minimal breakage risk
- excellent strength
- nylon reinforced quality

Color: brown

Recommended speed: 15000 min⁻¹

Maximum speed: 35000 min⁻¹

Thickness	ø	REF	Quantity	REF	Quantity
0.50 mm	26 mm	130-111-00	20 pieces	130-111-40	40 pieces
1.00 mm	26 mm	130-112-00	20 pieces	130-112-40	40 pieces
0.30 mm	26 mm	130-113-00	20 pieces	130-113-40	40 pieces
0.20 mm	22 mm	130-114-00	20 pieces		



TX separating disc

- maximum cutting efficiency

Application: CoCr alloys, ceramics, precious metal

Color: brown

Recommended speed: 15000 min⁻¹

Maximum speed: 25000 min⁻¹

Thickness	ø	REF	Quantity
0.26 mm	22 mm	130-512-00	100 pieces



TX-Flex separating disc

- extremely thin
- maximum cutting efficiency

Application: CoCr alloys, ceramics, precious metal

Color: brown

Recommended speed: 15000 min⁻¹

Maximum speed: 25000 min⁻¹

Thickness	ø	REF	Quantity
0.15 mm	22 mm	130-511-00	25 pieces



Separating and grinding discs

T separating disc

Application: CoCr alloys, precious metal

Color: brown

Recommended speed: 15000 min⁻¹

Maximum speed: 25000 min⁻¹



ISO Number	Thickness	ø	REF	Quantity
613.900.327.504.130	0.55 mm	13 mm	130-513-00	100 pieces
613.900.327.504.250	0.60 mm	25 mm	130-824-00	100 pieces
613.900.327.504.220	0.60 mm	22 mm	130-324-00	100 pieces
613.900.327.504.400	0.75 mm	40 mm	130-137-00	100 pieces
613.900.327.504.340	1.60 mm	34 mm	130-131-00	50 pieces
613.900.327.504.400	1.00 mm	40 mm	130-138-00	100 pieces



Grinding disc

- for fast grinding

Application: metal

Color: brown

Recommended speed: 15000 min⁻¹

Maximum speed: 25000 min⁻¹

ISO Number	Thickness	ø	REF	Quantity
613.900.327.504.340	3.00 mm	34 mm	130-634-00	25 pieces



Grinding wheel

- extremely rapid grinding action
- aluminum-oxide based, will not contaminate surfaces

Application: all metals, ceramics

Color: white

Recommended speed: 15000 min⁻¹

Maximum speed: 15000 min⁻¹

Thickness	ø	REF	Quantity
3.00 mm	22 mm	131-322-50	100 pieces

Pregrinding media

- for coarse grinding
- ceramic bonded corundum grinding points

Color: brown

Recommended speed: 15000 min⁻¹

Maximum speed: 30000 min⁻¹

ISO Number	Form	Hardness	Grain size	REF	Quantity
635.104.274.522.130	bullet, long	soft	coarse	134-000-00	12 pieces



Grinding point

- ceramic bonded corundum grinding points
- high durability
- exceptional grinding efficiency

Color: brown

Recommended speed: 30000–40000 min⁻¹

Maximum speed: 60000 min⁻¹

ISO Number	Form	Hardness	Grain size	REF	Quantity
635.104.107.522.065	cylindrical	soft	coarse	132-201-00	100 pieces
635.104.107.522.050	cylindrical	soft	medium	132-202-00	100 pieces
635.104.173.522.035	conical, (truncated conical)	soft	medium	132-203-00	100 pieces
635.104.316.522.085	wheel, inverted conical and conical, proximal concave	soft	medium	132-204-00	100 pieces
635.104.027.522.070	inverted conical, concave	soft	medium	132-205-00	100 pieces



Grinding points

Grinding point

- ceramic bonded corundum grinding points
- high durability
- exceptional grinding efficiency

Color: pink

Recommended speed: 20000–30000 min⁻¹

Maximum speed: 60000 min⁻¹



ISO Number	Form	Hardness	Grain size	REF	Quantity
625.104.107.523.065	cylindrical	medium	coarse	132-801-00	100 pieces
625.104.107.523.050	cylindrical	medium	coarse	132-802-00	100 pieces
625.104.173.523.035	conical, (truncated conical)	medium	medium	132-803-00	100 pieces
625.104.316.523.085	wheel, inverted conical and conical, proximal concave	medium	medium	132-804-00	100 pieces



Aloxin-Point

- 100 % clean cutting due to pure aluminum oxide
- prevents flaw marks

Application: non-precious ceramic bonding alloys, precious metal reduced ceramic bonding alloys

Color: violet

Maximum speed: 60000 min⁻¹



ISO Number	Form	Grain size	REF	Quantity
635.104.107.523.050	cylindrical	medium	135-851-00	12 pieces
635.104.199.523.035	conical, domed end	medium	135-852-00	12 pieces
635.104.266.523.060	bud, rounded, long	medium	135-853-00	12 pieces
635.104.197.523.025	conical, domed end	medium	135-855-00	12 pieces



Dressing stone

- for reshaping used grinding points and rubber polishers

Color: grey

ISO Number	Form	Grain size	REF	Quantity
635.000.600.523.750	grindstone, rectangular shape	medium	137-900-00	2 pieces

**Super hard metal burs and cutters
with cross tothing cut, coarse**

- high precision milled
- best cutting properties

Application: acrylics, cast partial denture

Recommended speed: 20000–25000 min⁻¹

Maximum speed: 50000 min⁻¹

ISO Number	Form	REF	Quantity
500.104.116.190.023	cylindrical, only side cutting	123-580-00	1 piece
500.104.137.190.023	cylindrical, end hemispherical	123-581-00	1 piece
500.104.292.190.023	torpedo, cylindrical	123-582-00	1 piece
500.104.001.190.023	spherical (round), ø 2.1 mm	123-583-00	1 piece
500.104.274.190.060	bullet	123-584-00	1 piece
500.104.194.190.023	conical, domed end	123-585-00	1 piece



**Super hard metal bur
with cross tothing cut, fine**

Application: crowns and bridges, cast partial denture

Recommended speed: 25000–30000 min⁻¹

Maximum speed: 50000 min⁻¹

ISO Number	Form	REF	Quantity
500.104.116.140.023	cylindrical, only side cutting	123-586-00	1 piece
500.104.292.140.023	torpedo, cylindrical	123-588-00	1 piece
500.104.274.140.060	bullet	123-590-00	1 piece
500.104.194.140.023	conical, domed end	123-591-00	1 piece



Burs and cutters

Super hard metal bur

with cross tothing cut, super fine

Application: crowns and bridges

Recommended speed: 35000–40000 min⁻¹

Maximum speed: 50000 min⁻¹



ISO Number	Form	REF	Quantity
500.104.137.110.023	cylindrical, end hemispherical	123-592-00	1 piece
500.104.194.110.023	conical, domed end	123-593-00	1 piece

Hard metal bur

drilltoothed, straight

- superior cutting properties

- high durability

Recommended speed: 25000–30000 min⁻¹

Maximum speed: 100000 min⁻¹

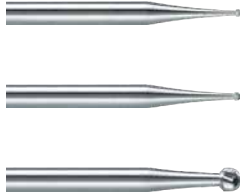

ISO Number	Form	REF	Quantity
500.104.001.001.006	spherical (round), ø 0.6 mm	123-600-00	1 piece
500.104.001.001.008	spherical (round), ø 0.8 mm	123-601-00	1 piece
500.104.001.001.023	spherical (round), ø 2.3 mm	123-602-00	1 piece

Hard metal bur

Application: all alloys, very good with titanium (low pressing force)

Maximum speed: 15000 min⁻¹

ISO Number	Size	Form	REF	Quantity
500.104.196.154.010	mini	conical, domed end	123-610-00	5 pieces
500.104.198.154.023	midi	conical, domed end	123-611-00	1 piece
500.104.263.154.040	maxi	bud, rounded, slender	123-612-00	1 piece
500.104.194.154.040	maxi plus	conical, domed end	123-613-00	1 piece



Super hard metal bur

with cross tothing cut, coarse

- high precision milled
- best cutting properties

Application: plaster, acrylics

Recommended speed: 15000–20000 min⁻¹

Maximum speed: 30000 min⁻¹

ISO Number	Form	REF	Quantity
500.104.263.190.070	bud, rounded, slender	180-308-00	1 piece



Super hard metal bur

with cross tothing cut, coarse

- high precision milled
- best cutting properties

Application: plaster, acrylics

Recommended speed: 20000–25000 min⁻¹

Maximum speed: 30000 min⁻¹

ISO Number	Form	REF	Quantity
500.104.237.220.060	pear	123-594-00	1 piece
500.104.194.220.060	conical, domed end	123-596-00	1 piece



Burs and cutters

Super hard metal bur

with mill tothing cut, wound right

- tungsten carbide
- precision cut
- best cutting properties

Application: CoCr alloys, acrylics

Recommended speed: 20000–25000 min⁻¹

Maximum speed: 30000 min⁻¹



ISO Number	Form	REF	Quantity
500.104.274.175.060	bullet	123-597-00	1 piece
500.104.194.175.045	conical, domed end	123-598-00	1 piece

Bur for acrylics

with mill tothing cut, straight

- cutting properties

Application: acrylics

Maximum speed: 15000 min⁻¹



ISO Number	Size	Form	REF	Quantity
310.104.266.171.040	small	bud, rounded, long	180-201-00	1 piece
310.104.266.171.050	medium	bud, rounded, long	180-202-00	1 piece
310.104.260.171.070	medium	bud, rounded	180-304-00	1 piece
310.104.260.171.080	large	bud, rounded	180-305-00	1 piece

Diasint

- sintered diamond burs
- extremely long working life compared to electroplated diamond burs
- metallic bond prevents fragmentation
- careful selection of grain sizes results in superior cutting action

Application: non-precious ceramic bonding alloys, precious metal alloys, ceramics, acrylics, cast partial denture alloys

Recommended speed: 30000 min⁻¹

Maximum speed: 50000 min⁻¹

ISO Number	Size	Form	REF	Quantity
807.107.197.524.021	small	conical, domed end	137-820-00	1 piece
807.104.166.524.031	small	conical pointed, slender	137-821-00	1 piece
807.104.111.524.023	small	cylindrical, front and side cutting	137-822-00	1 piece
807.104.172.524.031	small	conical, (truncated conical)	137-823-00	1 piece
807.104.198.524.031	small	conical, domed end	137-824-00	1 piece
807.104.141.524.027	small	cylindrical, end hemispherical	137-825-00	1 piece
807.104.012.524.016	small	inverted conical	137-829-00	1 piece
807.104.012.524.027	medium	inverted conical	137-830-00	1 piece



Diamond burs

Diasint

- sintered diamond burs
- extremely long working life compared to electroplated diamond burs
- metallic bond prevents fragmentation
- careful selection of grain sizes results in superior cutting action

Application: non-precious ceramic bonding alloys, precious metal alloys, ceramics, acrylics, cast partial denture alloys

Recommended speed: 20000 min⁻¹

Maximum speed: 35000 min⁻¹



ISO Number	Size	Form	REF	Quantity
807.104.167.524.050	large	conical pointed, slender	137-826-00	1 piece
807.104.200.524.050	large	conical, domed end	137-827-00	1 piece
807.104.143.524.050	large	cylindrical, end hemispherical	137-828-00	1 piece
807.104.012.524.047	large	inverted conical	137-831-00	1 piece



Diasint diamond disc

- sintered on both sides to 2 mm

Application: ceramics

Maximum speed: 10000 min⁻¹

ISO Number	Grain size	Thickness	ø	REF	Quantity
806.104.354.514.210	50 µm (fine)	0.16 mm	21 mm	137-850-00	1 piece



Diasint diamond disc, rigid

- sintered on both sides to 2 mm

Application: non-precious alloys, precious metal alloys

Maximum speed: 10000 min⁻¹

ISO Number	Grain size	Thickness	ø	REF	Quantity
806.104.354.524.200	75 µm	0.19 mm	21 mm	137-855-00	1 piece

Diamond burs

Diasint diamond disc, rigid

- fully sintered

Application: non-precious alloys (not for ceramic bonding alloys)

Maximum speed: 10000 min⁻¹

ISO Number	Grain size	Thickness	ø	REF	Quantity
807.104.327.534.210	180 µm	0.40 mm	22 mm	137-856-00	1 piece



Diamond disc

- super flexible
- coated on both sides

Application: ceramics, acrylics, metal

Recommended speed: 10000 min⁻¹

Maximum speed: 15000 min⁻¹

ISO Number	Grain size	Thickness	ø	REF	Quantity
806.104.355.504.220	extra fine	0.15 mm	22 mm	137-807-00	1 piece



Diamond cleaning stone

For the rapid cleaning of sintered diamond burs and discs.

REF 137-810-00	1 piece
-----------------------	---------



Diasint Zr super

Sinter diamond trimmer

- organic binder
- for coarse grinding and contouring
- does not leave rough surface or overheat

Application: ZrO₂ structure

Recommended speed: 5000 min⁻¹

Maximum speed: 7000 min⁻¹

Form	REF	Quantity
knife-edge	137-841-00	1 piece



Diamond burs



Diasint Zr medium

Diamond trimmer

- synthetic binder
- for easier removal and trimming
- optimal surface conditioning
- does not leave rough surface or overheat

Application: ZrO₂ structure

Recommended speed: 5000 min⁻¹

Maximum speed: 7000 min⁻¹

ISO Number	Form	REF	Quantity
805.104.042.534.150	wheel	137-842-00	1 piece



Diasint Zr fine

Diamond trimmer

- synthetic binder
- for easier removal and trimming
- optimal surface conditioning
- does not leave rough surface or overheat

Application: ZrO₂ structure

Recommended speed: 5000 min⁻¹

Maximum speed: 7000 min⁻¹

ISO Number	Form	REF	Quantity
805.104.014.524.115	inverted conical	137-843-00	1 piece

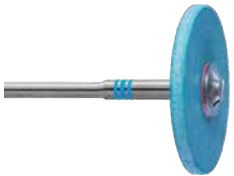

Diasint Zr soft

diamond-impregnated disc

- especially suitable for working on margins
- does not overheat

Application: all ceramics, ZrO₂ structure

Recommended speed: 5000 min⁻¹

Maximum speed: 7000 min⁻¹

ISO Number	Form	REF	Quantity
802.104.373.523.250	disc	137-844-00	1 piece



Diasint Zr set

Application: ZrO₂ structure

Recommended speed: 5000 min⁻¹

Maximum speed: 7000 min⁻¹

REF 137-840-00	1 set
-----------------------	-------

Contents:

1 x Diasint Zr super	REF 137-841-00
1 x Diasint Zr medium	REF 137-842-00
1 x Diasint Zr fine	REF 137-843-00
1 x Diasint Zr soft	REF 137-844-00

Sintered diamond**Application:** ceramicsRecommended speed: 10000 min⁻¹Maximum speed: 20000 min⁻¹

ISO Number		Form	Grain size	REF	Quantity
807.104.173.513.030	Sidio I	conical, (truncated conical)	fine	260-803-01	1 piece
807.104.027.513.027	Sidio II	inverted conical, concave, front and side cutting	fine	260-803-02	1 piece
807.104.257.513.030	Sidio III	bud, slender	fine	260-803-03	1 piece
807.104.161.513.025	Sidio IV	conical, pointed	fine	260-803-04	1 piece

**Diamond disc Highflex****Application:** ceramicsRecommended speed: 3000 min⁻¹Maximum speed: 5000 min⁻¹

ISO Number	Form	REF	Quantity
806.104.402.504.220	disc, very thin, perforated, circum- ference cutting from front and back	260-804-02	1 piece

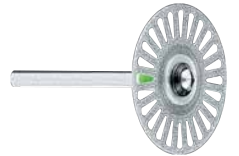
**Diamond disc Dia-Miniflex****Application:** ceramicsRecommended speed: 5000 min⁻¹Maximum speed: 10000 min⁻¹

ISO Number	Form	REF	Quantity
806.104.355.504.090	disc, very thin, circumference and edge cutting	260-804-01	1 piece



Mandrels

Mandrel



Version	Maximum speed	REF	Quantity
for discs and lens	20000 min ⁻¹	139-300-00	10 pieces
for cylinders	10000 min ⁻¹	139-100-00	10 pieces
for separating discs	30000 min ⁻¹	139-301-00	10 pieces
for emery cloth	16000 min ⁻¹	139-500-00	10 pieces



Emery cloth

Grain size	Width	REF	Quantity
120 = fine	15 mm	140-015-00	25 m
500 = very fine	15 mm	140-016-00	25 m

Silichrom polisher

- unmounted
- faster cutting action than standard rubber polisher
- rapid trimming
- less grinding dust
- pressureless polishing
- minimal heat generation

Application: CoCr alloys

ISO Number	Form	Grain size	REF	Quantity
618.900.114.533.070	cylindrical, front and side cutting	coarse	138-645-00	100 pieces
618.900.372.533.220	disc	coarse	138-640-00	100 pieces



Rubber polisher

- abrasive performance medium – coarse

Application: non-precious alloys

Color: black

ISO Number	Form	ø	REF	Quantity
653.900.372.545.220	disc	22 mm	138-103-00	100 pieces
653.900.114.545.070	cylindrical, front and side cutting	7 mm	138-303-00	100 pieces



Rubber polisher

- abrasive performance medium

Application: non-precious alloys, titanium

Color: grey

ISO Number	Form	ø	REF	Quantity
653.900.372.524.220	disc	22 mm	138-102-00	100 pieces
653.900.114.524.070	cylindrical, front and side cutting	7 mm	138-302-00	100 pieces



Polishing tools and accessories

Rubber polisher

- abrasive performance fine

Application: non-precious alloys, precious metal alloys

Color: green



ISO Number	Form	ø	REF	Quantity
653.900.372.525.220	disc	22 mm	138-101-00	100 pieces
653.900.114.525.070	cylindrical, front and side cutting	7 mm	138-301-00	100 pieces
653.900.303.525.220	knife-edge	22 mm	138-501-00	100 pieces

Rubber polisher

- abrasive performance very fine

Application: precious metal alloys, ceramics, titanium

Color: red



ISO Number	Form	ø	REF	Quantity
653.900.372.513.220	disc	22 mm	138-601-00	100 pieces
653.900.114.513.070	cylindrical, front and side cutting	7 mm	138-602-00	100 pieces
653.900.303.513.220	knife-edge	22 mm	138-603-00	100 pieces



Rubber polishing point, mounted

For demanding preparation techniques.

- centralized, steady design
- intensive rapid surface finishing

Application: non-precious alloys, titanium

Color: black

ISO Number	Form	Grain size	REF	Quantity
653.104.292.525.050	torpedo, cylindrical	fine	138-605-00	12 pieces

Rubber polishing point, mounted

For demanding preparation techniques.

- centralized, steady design
- silky smooth surface polish

Application: non-precious alloys, precious metal alloys

Color: green



ISO Number	Form	REF	Quantity
653.104.292.525.050	torpedo, cylindrical	138-606-00	12 pieces

Silicon polisher, mounted

- non-damaging to metal parts, clasps

Application: orthodontics appliances, pre-polishing of cast partial denture, soft remaining relining

Recommended speed: 10000 min⁻¹

Maximum speed: 15000 min⁻¹

ISO Number	Form	REF	Quantity
658.104.201.524.150	conical, domed end	138-620-00	10 pieces
658.104.497.524.100	bud, oval	138-623-00	10 pieces



Polishing brush

Short Chungking bristles, for polishing machines.

Application: orthodontics, crowns and bridges, cast partial denture

Maximum speed: 6000 min⁻¹

Number of brush ranges	ø	REF	Quantity
2	60 mm	141-711-00	10 pieces
3	60 mm	141-712-00	10 pieces



Polishing brush

For polishing machines.

Application: orthodontics, crowns and bridges, plastic prosthetics, cast partial denture

Maximum speed: 2800 min⁻¹

ø	REF	Quantity	REF	Quantity
50 mm	141-700-00	1 piece	141-700-10	10 pieces



Polishing brush

Combination Chungking bristles/linen, for polishing machines.

Application: orthodontics, crowns and bridges, plastic prosthetics

Maximum speed: 1500 min⁻¹

ø	REF	Quantity
80 mm	141-710-00	1 piece



Polishing tools and accessories



Brush, stainless steel

- stainless, for polishing machines

Application: crowns and bridges, cast partial denture

Recommended speed: 3000–4000 min⁻¹

Maximum speed: 5000 min⁻¹

ø	REF	Quantity
70 mm	127-870-00	1 piece



Palatal cup brush

Chungking bristles, for polishing machines.

Application: orthodontics, plastic prosthetics

Maximum speed: 3000 min⁻¹

ø	REF	Quantity	REF	Quantity
30 mm	141-713-10	1 piece	141-713-00	10 pieces



Cloth polishing brush

For polishing machines.

Application: orthodontics, crowns and bridges, plastic prosthetics, cast partial denture

Maximum speed: 5000 min⁻¹

ø	REF	Quantity
100 mm	181-200-00	1 piece



Chamois leather polishing brush

For high shine polish, for polishing machines.

Application: orthodontics, crowns and bridges, plastic prosthetics, cast partial denture

Maximum speed: 1500 min⁻¹

ø	REF	Quantity
90 mm	181-201-00	1 piece



Cloth polishing brush, mounted

For handpiece.

Application: orthodontics, crowns and bridges, plastic prosthetics, cast partial denture

Recommended speed: 1500–4000 min⁻¹

Maximum speed: 5000 min⁻¹

ø	REF	Quantity
20 mm	181-100-01	6 pieces

Brush, stainless steel

- stainless, for handpiece

Application: crowns and bridges, cast partial denture

Recommended speed: 3000–4000 min⁻¹

Maximum speed: 5000 min⁻¹

ø	REF	Quantity	REF	Quantity
21 mm	127-922-00	1 piece	127-922-10	10 pieces



Brush for polishing

- Chungking bristles, for handpiece

Application: crowns and bridges, cast partial denture

Recommended speed: 3000–4000 min⁻¹

Maximum speed: 5000 min⁻¹

ø	REF	Quantity
21 mm	141-800-00	10 pieces



Pointed brush

for polishing areas difficult to access

e.g. fissures, inner surface of telescopes, etc.

Color: black

Maximum speed: 10000 min⁻¹

REF 141-810-00	10 pieces
----------------	-----------



Tiger Brilliant polishing paste

- quick and high shine polishing paste for super shiny metal surfaces

Application: CoCr alloys, precious metal alloys, NiCr alloys, titanium

REF 190-350-00	400 g
REF 190-350-50	60 g



Tiger Starshine Universal finishing paste

- the ideal paste for final polishing

Application: all alloys, all metals

REF 190-301-00	50 ml
----------------	-------



Tiger Diamond polishing paste

- diamond polishing paste for use with handpiece
- high shine on all metals, ceramics and composites

Application: all alloys, all metals, ceramics, acrylics

REF 190-302-00	50 g
----------------	------



Polishing tools and accessories



Nacera® Shine Zr

Nacera® Shine Zr is a diamond polishing paste to quickly achieve a long-lasting high-quality shine on zirconium oxide.

- high gloss finish of the fully-ceramic restoration in 90 seconds
- long-lasting high-quality shine on zirconium oxide
- very high diamond content and an exceptionally hard consistency – for less work and lower costs
- easy to handle and efficient in terms of consumption
- effective and time-saving to use

Application: ceramics

REF 271-130-14

14 g

NEW



Nacera® Shine Zr Special Edition

Nacera® Shine Zr is a diamond polishing paste to quickly achieve a long-lasting high-quality shine on zirconium oxide.

- high gloss finish of the fully-ceramic restoration in 90 seconds
- long-lasting high-quality shine on zirconium oxide
- very high diamond content and an exceptionally hard consistency – for less work and lower costs
- easy to handle and efficient in terms of consumption
- effective and time-saving to use

Application: ceramics

REF 271-131-14

14 g

NEW



Edelweiss acrylic dry polishing paste

REF 190-100-00

80 g



Edelweiss acrylic polishing liquid

REF 190-200-00

1000 g

Polishing tools and accessories

Bur stand magnetic holder

Partly plastic.

- permanent magnets ensure firm retention of the instruments
- magnet holder without instruments
- do not use disinfectants containing ethanol, phenol or alcohol

REF 089-430-00

1 piece



Bur stand

Material: plastic

- for 12 burs or abrasive stones.
- Bur stand without instruments
- shaft ø: 2.35 mm
- do not use disinfectants containing ethanol, phenol or alcohol

Color: transparent, clear

REF 089-431-00

1 piece



Crown Master forceps

Firm grip of crowns. Heat-resistant up to 200 °C / 392 °F.

REF 260-300-02

1 piece



rematitan® finishing kit



rematitan® finishing kit

rematitan® is a soft, ductile material, which requires appropriate tools for trimming and polishing.

The kit contains all tools required to efficiently trim and polish titanium.

The enclosed instructions inform about sequence of finishing and important criteria of the tools used.

Consists of:

- Supercut ST cutting disc, ø 40 mm (1 piece)
- Supercut STM cutting disc, ø 26 mm (2 pieces)
- TX cutting disc, ø 22 mm (5 pieces)
- Hard-alloy cutter, mini (1 piece)
- Hard-alloy cutter, midi (1 piece)
- Hard-alloy cutter, maxi (1 piece)
- Hard-alloy cutter, maxi plus (1 piece)
- Aloxin grinder, violet, conical (1 piece)
- Aloxin grinder, violet, bud (1 piece)
- Emery cloth – 500 – (70 cm)
- Rubber polisher grey, disc (4 pieces)
- Rubber polisher red, disc (4 pieces)
- Rubber polisher red, knife-edge (4 pieces)
- Rubber polisher red, cylindrical (4 pieces)
- Polishing brush, ø 21 mm (4 pieces)
- Polishing brush, ø 60 mm, Chungking bristles, 2 rows (1 piece)
- Pointed brush (1 piece)
- Tiger brilliant polishing paste (60 g)
- Mandrel for disc and knife-edge (6 pieces)
- Mandrel for cylinder (1 piece)
- Mandrel for emery cloth (1 piece)

Application: titanium

REF 135-500-00

1 set



A series of horizontal lines for writing, consisting of 20 evenly spaced lines across the page.

Impression materials	Page 278
Laboratory accessories	Page 279
Isolation and waxes	Page 280
Grid strengtheners	Page 281
Accessories	Page 282



Prosthetics.

Proven product quality.

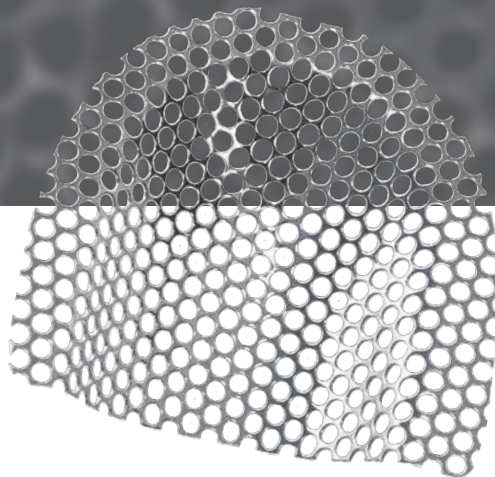

DENTAURUM
**ONLINE
SHOP**
shop.dentaurum.com





From impressions to grid strengtheners.

A diverse range of products available for impression taking and model casting to various different types of grid strengtheners. They all share the same superior product quality.

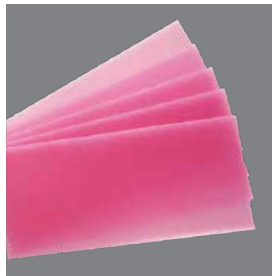

Orthalgenat® Duo

The universal impression material.

Rapidur®

Synthetic hard plaster, class 4.

Model gloss

Impregnation for demonstration models.

Separating medium

Thin, abrasion-resistant film.

Modelling wax, pink

Good modeling characteristics for wax-ups.

Grid strengtheners and wire mesh

Stainless steel or gold-plated stainless steel.

Tin foil

Spacer foil in various thicknesses.

Ultrasonic cleaning solutions

For use in ultrasonic cleaners.

Impression materials



Orthalgenat® Duo

Impression material incl. measuring set.

Flavor	Color	REF	Quantity
mint	green	150-501-20	1 kg
mint	green	150-509-20	9 x 1 kg
mint	green	150-520-20	20 x 1 kg
berry	violet	150-501-30	1 kg
berry	violet	150-509-30	9 x 1 kg
berry	violet	150-520-30	20 x 1 kg



Packaging: 1 kg (box), 9 x 1 kg and 20 x 1 kg (bag)
DIN/EN/ISO 21563



Orthalgenat® Ex

Impression tray cleaner. For removing alginate and plaster residue. Concentrate for manual or ultrasonic cleaning.

REF 150-010-00	1.5 kg
-----------------------	--------

Rapidur®

Synthetic dental stone

- extra hard, low expansion
- quick-setting

Application:

orthodontics, cast partial denture work,
precious metal, acrylics, ceramics

Norm: DIN EN ISO 6873

Class 4

Mixing ratio (g : ml)	100 : 24
Setting expansion	max. 0.15 %
Working time	min. 3 min
Compression resistance	min. 35 MPa
Setting time	max. 30 min
Color	white

REF 164-450-00	6 kg
----------------	------

**Mixing bowl**

For plaster, impression and investment materials, easy to clean.

Capacity	REF	Quantity
600 ml	164-650-00	1 piece
400 ml	164-651-00	1 piece

**Model gloss**

Environmentally friendly impregnating liquid for plaster demonstration models (e.g. Rapidur®, REF 164-450-00) to provide gloss and dust resistance.

REF 166-450-00	4.5 kg
----------------	--------



Isolation and waxes



Separating medium

Special alginate-based separating agent that forms a thin, abrasive-resistant separating film.

Separates:

- plaster from acrylic
- plaster from plaster

Color	REF	Quantity
pink	162-800-00	1000 ml



Mixing bowl made of silicone

Flexible, with suction base. For all mixing jobs in the practice and laboratory.

Do not use with silicone materials!

Capacity	REF	Quantity
5 ml	162-501-00	3 pieces
25 ml	162-502-00	1 piece
75 ml	162-503-00	1 piece



Modeling wax

For acrylic work, construction bites etc.

- well adaptable
- very easy to model
- firm up to approx. 37 °C / 98.6 °F
- easy fixation of teeth

Melting point	Dimensions (L x W)	Thickness	Color	REF	Quantity
60 °C / 140 °F	175 x 80 mm	1.5 mm	pink	119-150-00	500 g

CE

Flexapona® special wax

acc. to Uhlig

- for bite registration (as bite wafer or bite rim)
- for adhesive borders on impression trays
- soft, flexible and adhesive



Dimensions (L x W)	Thickness	Color	REF	Quantity
120 x 15 mm	1.0 mm	red	124-003-00	50 pieces
200 x 10 mm	1.0 mm	red	124-002-00	50 pieces
200 x 10 mm	1.0 mm	white	124-202-00	50 pieces

CE

Grid strengthener

The numerous round perforations provide excellent resin bond to ensure a strong, stabilized denture base.

Material No.: 1.4301

Perforations \varnothing : 2.5 mm

Thickness: 0.4 mm

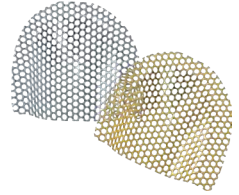

Material	REF	Quantity
Stainless steel	318-004-00	10 pieces
Stainless steel, gold plated (24 carat)	318-104-00	10 pieces

**Wire mesh**

Material No.: 1.4301

Wire mesh: 10 x 10 cm

Material	Mesh version	REF	Quantity
Stainless steel	fine	316-110-00	1 piece
Stainless steel	coarse	317-110-00	1 piece
Stainless steel, gold plated (24 carat)	fine	316-210-00	1 piece
Stainless steel, gold plated (24 carat)	coarse	317-210-00	1 piece

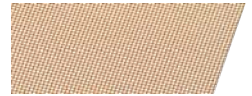
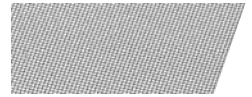

Accessories



Marking pencil

indelible

Color	REF	Quantity
black	043-800-00	1 piece
red	043-900-00	1 piece



Marking pencil

Wax pencil

Color	REF	Quantity
white	043-700-00	6 pieces



Matrix band on roll

Material No.: 1.4310, spring hard.

Thickness x width	Length	REF	Quantity
0.05 x 5.00 mm	1 m	831-601-00	1 piece
0.05 x 5.00 mm	10 m	831-701-00	1 piece
0.05 x 6.00 mm	1 m	831-606-00	1 piece
0.05 x 7.00 mm	1 m	831-603-00	1 piece
0.05 x 7.00 mm	10 m	831-703-00	1 piece

CE



Tin foil on roll

Pure tin 99.9 %

Thickness x width	Length	REF	Quantity
0.1 x 100 mm	342 cm	324-610-00	250 g
0.2 x 100 mm	171 cm	324-620-00	250 g
0.25 x 100 mm	136 cm	324-725-00	250 g
0.3 x 100 mm	114 cm	324-730-00	250 g
0.4 x 100 mm	85.5 cm	324-740-00	250 g
0.5 x 100 mm	68 cm	324-750-00	250 g
0.6 x 100 mm	57 cm	324-760-00	250 g

Ultrasonic cleaning solution

To remove	REF	Quantity
Polishing paste, wax, grease	094-610-00	1000 ml
Plaster and plaster-bonded investment material	094-611-00	1000 ml
Calculus, cement, etching residues	094-612-00	1000 ml



Wires

Page 288

Clasps

Page 292



Wires and clasps.

Large selection – excellent quality.



DENTAURUM
**ONLINE
SHOP**
shop.dentaurum.com





A wide range of products.

The Dentaurum product range supports your daily lab work and makes life easier. You will find an exceptionally large selection of wires and preformed wire clasps. remanium® wires are available in different grades of mechanical strength to be used in a wide range of prosthetic and orthodontic applications. Our offer of clasps includes the most popular clasps in prosthetics.

Perfect in every detail.

All of Dentaurum's wire and clasp products are extremely precise and dimensionally stable. This superior quality guarantees optimum results. Dentaurum has decades of experience in the development and production of wires which gives you, our customer, the confidence that you can rely on products that are functional and mechanically precise.

remanium®

Stainless steel wires.

Noninium®

Nickel free* stainless steel wires.

remaloy®

CoCr wires.

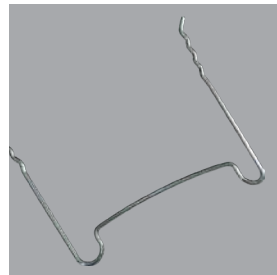

*Nickel trace elements of $\leq 0.2\%$ are due to the process of manufacturing

Wires



remanium® straight wire, round

Material: stainless steel

Strength category: spring hard · 1800–2000 N/mm²

Color coded packaging: red

ø	Length	REF	Quantity
0.40 mm / 16	each 380 mm	525-040-00	25 pieces
0.70 mm / 28	each 150 mm	527-004-00	1100 pieces
0.50 mm / 20	each 380 mm	535-002-00	25 pieces
0.60 mm / 23	each 380 mm	535-003-00	25 pieces
0.70 mm / 28	each 190 mm	527-005-00	900 pieces
0.70 mm / 28	each 300 mm	527-070-00	25 pieces
0.75 mm / 30	each 380 mm	535-005-00	25 pieces
0.80 mm / 31	each 150 mm	527-006-00	875 pieces
0.80 mm / 31	each 300 mm	527-080-00	25 pieces
0.90 mm / 36	each 300 mm	527-090-00	25 pieces
1.00 mm / 39	each 300 mm	527-100-00	25 pieces
1.15 mm / 45	each 380 mm	535-009-00	25 pieces

CE 0483



remanium® laboratory coil, round

Material: stainless steel

Strength category: hard · 1400–1600 N/mm²

ø	Length	REF	Quantity
0.70 mm / 28	30 m	513-070-00	1 piece
0.80 mm / 31	20 m	513-080-00	1 piece
0.90 mm / 36	10 m	513-090-00	1 piece
1.00 mm / 39	10 m	513-100-00	1 piece
1.20 mm / 47	10 m	513-120-00	1 piece
1.50 mm / 59	10 m	513-150-00	1 piece

CE 0483



remanium® clinical coil, round

Material: stainless steel

Strength category: hard · 1400–1600 N/mm²

ø	Length	REF	Quantity
0.70 mm / 28	165 m	514-070-00	1 piece
0.80 mm / 31	125 m	514-080-00	1 piece
0.90 mm / 36	100 m	514-090-00	1 piece
1.00 mm / 39	80 m	514-100-00	1 piece

CE 0483

remanium® laboratory coil, round

Material: stainless steel

Strength category: spring hard · 1800–2000 N/mm²

ø	Length	REF	Quantity
0.40 mm / 16	30 m	521-040-00	1 piece
0.50 mm / 20	50 m	523-050-00	1 piece
0.60 mm / 23	40 m	523-060-00	1 piece
0.70 mm / 28	30 m	523-070-00	1 piece
0.80 mm / 31	20 m	523-080-00	1 piece
0.90 mm / 36	10 m	523-090-00	1 piece
1.00 mm / 39	10 m	523-100-00	1 piece
1.10 mm / 43	10 m	523-110-00	1 piece
1.20 mm / 47	10 m	523-120-00	1 piece
1.50 mm / 59	10 m	523-150-00	1 piece



CE 0483

remanium® clinical coil, round

Material: stainless steel

Strength category: spring hard · 1800–2000 N/mm²

ø	Length	REF	Quantity
0.60 mm / 23	225 m	524-060-00	1 piece
0.70 mm / 28	165 m	524-070-00	1 piece
0.80 mm / 31	125 m	524-080-00	1 piece
0.90 mm / 36	100 m	524-090-00	1 piece
1.00 mm / 39	80 m	524-100-00	1 piece
1.10 mm / 43	70 m	524-110-00	1 piece



CE 0483

remanium® wire on coils, half-round

Material: stainless steel

Strength category: hard · 1400–1600 N/mm²

ø	Length	REF	Quantity
1.30 x 0.65 mm	10 m	308-513-00	1 piece
1.50 x 0.75 mm	10 m	308-515-00	1 piece
1.75 x 0.90 mm	10 m	308-518-00	1 piece
2.00 x 1.00 mm	10 m	308-520-00	1 piece



CE 0483

Wires



remanium® clinical coil, half-round

Material: stainless steel

Strength category: hard · 1400–1600 N/mm²

ø	Length	REF	Quantity
1.30 x 0.65 mm	90 m	308-713-00	1 piece
1.50 x 0.75 mm	65 m	308-715-00	1 piece
1.75 x 0.90 mm	50 m	308-718-00	1 piece

CE 0483



remanium® wire on coils, oval

Material: stainless steel

Strength category: hard · 1400–1600 N/mm²

ø	Length	REF	Quantity
2.40 x 1.40 mm	10 m	385-624-00	1 piece
3.00 x 1.50 mm	10 m	385-630-00	1 piece

CE 0483



Noninium® wire on coils, round

Material: nickel free* stainless steel

Strength category: hard · 1400–1600 N/mm²

ø	Length	REF	Quantity
0.70 mm / 28	30 m	520-070-10	1 piece
0.80 mm / 31	20 m	520-080-10	1 piece
0.90 mm / 36	10 m	520-090-10	1 piece
1.20 mm / 47	10 m	520-120-10	1 piece

CE 0483

* Nickel trace elements of ≤ 0.05 % are due to the process of manufacturing



Noninium® wire on coils, round

Material: nickel free* stainless steel

Strength category: spring hard · 1800–2000 N/mm²

ø	Length	REF	Quantity
0.60 mm / 23	40 m	520-062-10	1 piece
0.70 mm / 28	30 m	520-072-10	1 piece
0.80 mm / 31	20 m	520-082-10	1 piece
0.90 mm / 36	10 m	520-092-10	1 piece

CE 0483

* Nickel trace elements of ≤ 0.05 % are due to the process of manufacturing

remaloy® straight wire, round

Recommended for Quad Helix, Crozat appliances, palatal and lingual bars etc.

Can be heat treated · 450 °C / 842 °F for about 5 min

Material: CoCr

Strength category: hard · 1400–1600 N/mm²

Color coded packaging: blue



ø	Length	REF	Quantity
0.70 mm / 28	each 380 mm	528-070-00	10 pieces
0.80 mm / 31	each 380 mm	528-080-00	10 pieces
0.90 mm / 36	each 380 mm	528-090-00	10 pieces
1.00 mm / 39	each 380 mm	528-100-00	10 pieces
1.10 mm / 43	each 380 mm	528-110-00	10 pieces
1.20 mm / 47	each 380 mm	528-120-00	10 pieces
1.30 mm / 51	each 380 mm	528-130-00	10 pieces
1.50 mm / 59	each 380 mm	528-150-00	10 pieces

CE 0483

remaloy® straight wire, half-round

Can be heat treated · 450 °C / 842 °F for about 5 min

Material: CoCr

Strength category: spring hard · 1800–2000 N/mm²

Color coded packaging: blue



ø	Length	REF	Quantity
1.50 x 0.75 mm	each 380 mm	528-155-00	10 pieces
1.75 x 0.90 mm	each 380 mm	528-158-00	10 pieces

CE 0483

remaloy® straight wire, rectangular rounded

With rounded edges, for use as TPA or reinforcing bow.

Can be heat treated · 450 °C / 842 °F for about 5 min

Material: CoCr

Strength category: hard plus · 1600–1800 N/mm²

Color coded packaging: blue



ø	Length	REF	Quantity
1.92 x 0.90 mm	each 380 mm	528-159-00	10 pieces

CE 0483



Clasps

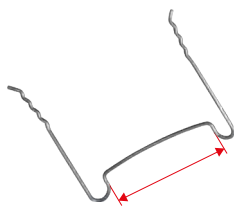

Noninium® standard labial arch

Material: Nickel free* stainless steel

Strength category: spring hard · 1800–2000 N/mm²

ø	Length mesial-mesial	REF	Quantity
0.80 mm / 31	28 mm	621-028-01	10 pieces
0.80 mm / 31	31 mm	621-031-01	10 pieces
0.80 mm / 31	34 mm	621-034-01	10 pieces
0.80 mm / 31	37 mm	621-037-01	10 pieces
0.80 mm / 31	40 mm	621-040-01	10 pieces
0.80 mm / 31	43 mm	621-043-01	10 pieces
0.80 mm / 31	46 mm	621-046-01	10 pieces

CE

* Nickel trace elements of ≤ 0.05 % are due to the process of manufacturing



Noninium® Adams clasp assortment

Strength category: spring hard · 1800–2000 N/mm²

1 assortment = 250 pieces

Material: Nickel free* stainless steel

ø 0.70 mm / 28

REF 621-500-01	1 assortment
-----------------------	--------------

CE

Contents:

30 x Adams clasps, 7 mm	REF 621-404-01
30 x Adams clasps, 8 mm	REF 621-405-01
40 x Adams clasps, 9 mm	REF 621-406-01
60 x Adams clasps, 10 mm	REF 621-407-01
60 x Adams clasps, 11 mm	REF 621-408-01
30 x Adams clasps, 12 mm	REF 621-409-01
1 x Ruler	REF 766-000-00

* Nickel trace elements of ≤ 0.05 % are due to the process of manufacturing

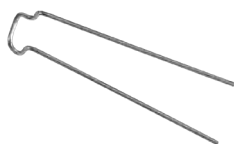

Noninium® Adams clasp

Material: Nickel free* stainless steel

Strength category: spring hard · 1800–2000 N/mm²

ø	Length mesial-distal	REF	Quantity
0.70 mm / 28	7 mm	621-404-01	10 pieces
0.70 mm / 28	8 mm	621-405-01	10 pieces
0.70 mm / 28	9 mm	621-406-01	10 pieces
0.70 mm / 28	10 mm	621-407-01	10 pieces
0.70 mm / 28	11 mm	621-408-01	10 pieces
0.70 mm / 28	12 mm	621-409-01	10 pieces

CE

* Nickel trace elements of ≤ 0.05 % are due to the process of manufacturing



Noninium® triangular clasp

Material: Nickel free* stainless steel

Strength category: hard · 1400–1600 N/mm²

ø	Length	REF	Quantity
0.70 mm / 28	each 36 mm	621-300-01	100 pieces



* Nickel trace elements of ≤ 0.05 % are due to the process of manufacturing

NEW**Noninium® arrow clasp**

Material: Nickel free* stainless steel

Strength category: spring hard · 1800–2000 N/mm²

ø	Length	REF	Quantity
0.70 mm / 28	each 41 mm	621-200-01	100 pieces



* Nickel trace elements of ≤ 0.05 % are due to the process of manufacturing

NEW**Noninium® ball retainer clasp**

Material: Nickel free* stainless steel

Strength category: hard · 1400–1600 N/mm²

ø	Length	REF	Quantity
0.70 mm / 28	each 38 mm	620-207-02	100 pieces
0.80 mm / 32	each 38 mm	620-208-02	100 pieces
0.90 mm / 36	each 38 mm	620-209-02	100 pieces



* Nickel trace elements of ≤ 0.05 % are due to the process of manufacturing

NEW**remanium® ball retainer clasp**

Ball ø: 1.6 mm

Material: Stainless steel

Strength category: hard · 1400–1600 N/mm²

ø	Length	REF	Quantity
0.70 mm / 28	each 38 mm	620-107-00	100 pieces
0.80 mm / 31	each 38 mm	620-108-00	100 pieces
0.90 mm / 36	each 38 mm	620-109-00	100 pieces
1.00 mm / 39	each 38 mm	620-110-00	100 pieces

**remanium® arrow clasp**

Material: Stainless steel

Strength category: hard · 1400–1600 N/mm²

ø	Length	REF	Quantity
0.80 mm / 31	each 40 mm	620-708-00	10 pieces



Clasps



Guide pin

acc. to G. Müller®

Guide pin between upper and lower plates intended for bite correction of Angle Class II + Class III.

Material: Stainless steel

REF 607-204-00	2 pieces
REF 607-204-30	20 pieces

CE



Guide pin

acc. to Hinz

Material: Stainless steel

ø	REF	Quantity	REF	Quantity
1.50 mm / 59	607-202-00	1 piece	607-202-30	10 pieces

CE



Lingual bar

Anatomically shaped e.g. for occlusion plates.

Material: Stainless steel

Length	☑	REF	Quantity
6 cm	3.0 x 1.5 mm	311-306-30	10 pieces
7 cm	3.0 x 1.5 mm	311-307-30	10 pieces
8 cm	3.0 x 1.5 mm	311-308-30	10 pieces

CE



Strengtheners on coils

Twisted and rolled flat.

Material: Stainless steel

Material No.: 1.4404

Length	☑	REF	Quantity
10 m	1.8 x 0.8 mm	312-106-00	1 piece
10 m	2.4 x 0.8 mm	312-107-00	1 piece

CE

Grid strengthener

The numerous round perforations provide excellent resin bond to ensure a strong, stabilized denture base.

Material No.: 1.4301

Perforations ø: 2.5 mm

Thickness: 0.4 mm

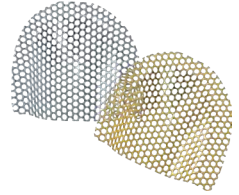

Material	REF	Quantity
Stainless steel	318-004-00	10 pieces
Stainless steel, gold plated (24 carat)	318-104-00	10 pieces

CE

Wire mesh

Material No.: 1.4301

Wire mesh: 10 x 10 cm

Material	Mesh version	REF	Quantity
Stainless steel	fine	316-110-00	1 piece
Stainless steel	coarse	317-110-00	1 piece
Stainless steel, gold plated (24 carat)	fine	316-210-00	1 piece
Stainless steel, gold plated (24 carat)	coarse	317-210-00	1 piece

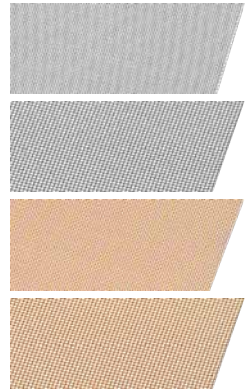

CE



Expansion screws

Standard expansion screws	Page	300
Special expansion screws	Page	305
Variety expansion screws	Page	315
RPE screws	Page	319
Accessories	Page	324



Expansion screws.

Perfect in form, function and design.

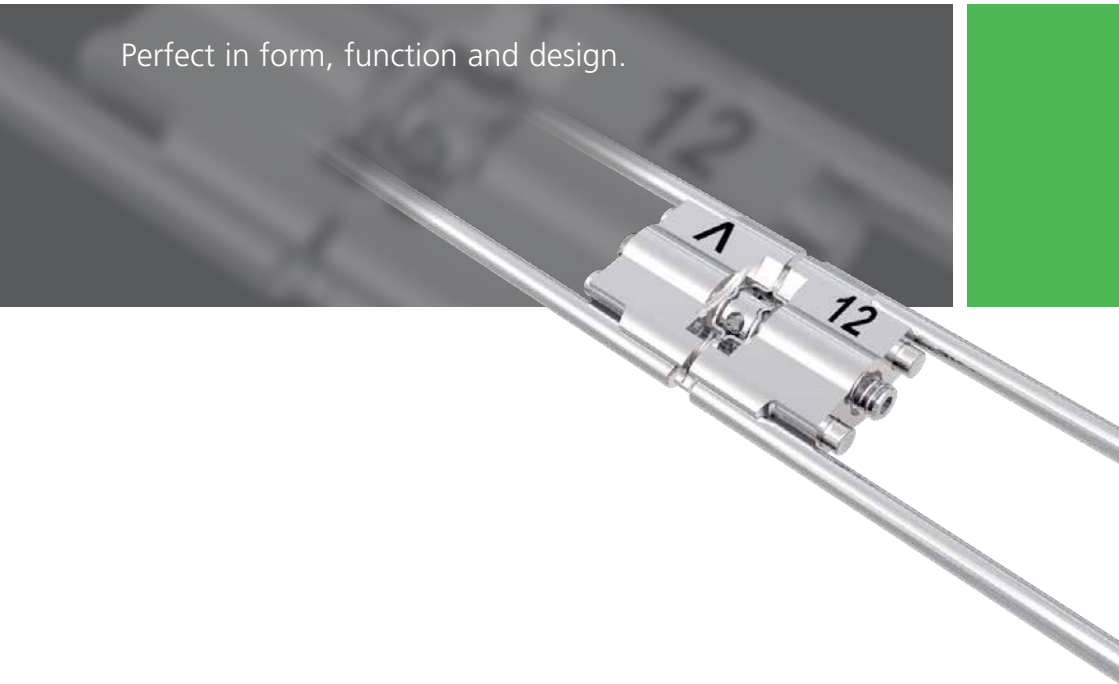

DENTAURUM
**ONLINE
SHOP**
shop.dentaurum.com



Perfect in form, function and design.

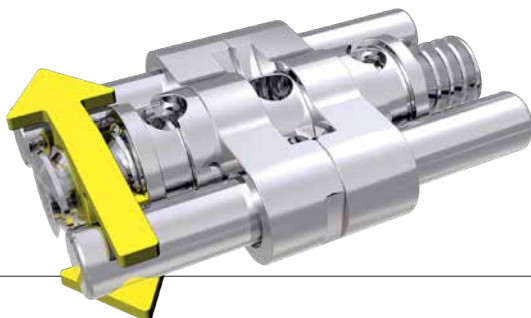

A wide range of products.

Dentaurum's selection of stainless steel expansion screws ranges from standard expansion screws to more complex special expansion screws. Titan hyrax® and rematitan® expansion screws, the biocompatible alternatives in pure titanium, round off this wide selection.

Perfect in every detail.

Dentaurum's expansion screws achieve wide expansion despite their small size. Built-in stops prevent the screws from coming apart. The screws are guaranteed to open evenly and not reverse inadvertently thanks to the friction on the thread, which has been carefully calculated, and an integrated stop mechanism. High precision manufacture and excellent quality ensure that the screw construction is strong and stable. Additional holes in the body ensure optimal retention in the acrylic.

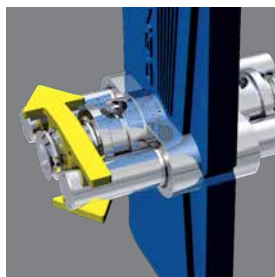

Dentaurum expansion screws

The right solution for every type of treatment.

Forward thrust double plate system acc. to Schaneng

The flexible system.

hyrax®

Special expansion screw for palatal expansion.

hyrax® click

The RPE screw with special feature
to prevent unwanted reversing.

Titan hyrax®

The world's first RPE screw in titanium.

Variety

The versatile, multi-functional expansion screw.

Variety click

The special expansion screw with special feature
to prevent unwanted reversing.

Expansion screws

Standard expansion screws



Expansion screw Mini

Material: Stainless steel

- with **cone-shaped** expansion screw holder
 - skeleton design
 - holes in body of screws for better retention in acrylic
 - built-in stops prevent screws from coming apart
- With expansion screw key straight, small – standard.

Indication: for transverse expansion and distalization in the mandible or for especially narrow maxillae

Maximum expansion	4 x 1/4 turn	Directional arrow	REF	Quantity
6.5 mm	= 0.7 mm	Plastic, white	600-300-10	1 piece
6.5 mm	= 0.7 mm	Plastic, white	600-300-30	10 pieces
6.5 mm	= 0.7 mm	Plastic, white	600-300-60	100 pieces

CE

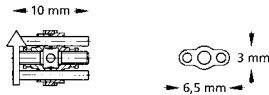

Expansion screw Mini

Material: Stainless steel

- with **wide** expansion screw holder
 - skeleton design
 - holes in body of screws for better retention in acrylic
 - built-in stops prevent screws from coming apart
- With expansion screw key straight, small – standard.

Indication: for transverse expansion and distalization in the mandible or for especially narrow maxillae

Maximum expansion	4 x 1/4 turn	Directional arrow	REF	Quantity
6.5 mm	= 0.7 mm	Plastic, white	600-320-10	1 piece
6.5 mm	= 0.7 mm	Plastic, white	600-320-30	10 pieces
6.5 mm	= 0.7 mm	Plastic, white	600-320-60	100 pieces

CE

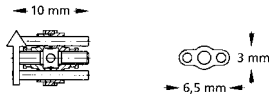

Expansion screw Medium

Material: Stainless steel

- with **cone-shaped** expansion screw holder
 - skeleton design
 - holes in body of screws for better retention in acrylic
 - built-in stops prevent screws from coming apart
- With expansion screw key straight, small – standard.

Indication: for transverse expansion and distalization in maxilla and mandible

Maximum expansion	4 x 1/4 turn	Directional arrow	REF	Quantity
7.5 mm	= 0.8 mm	Plastic, neon yellow	600-301-10	1 piece
7.5 mm	= 0.8 mm	Plastic, neon yellow	600-301-30	10 pieces
7.5 mm	= 0.8 mm	Plastic, neon yellow	600-301-60	100 pieces



CE

→ 11 mm →

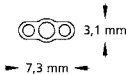

Expansion screw Medium

Material: Stainless steel

- with **wide** expansion screw holder
 - skeleton design
 - holes in body of screws for better retention in acrylic
 - built-in stops prevent screws from coming apart
- With expansion screw key straight, small – standard.

Indication: for transverse expansion and distalization in maxilla and mandible

Maximum expansion	4 x 1/4 turn	Directional arrow	REF	Quantity
7.5 mm	= 0.8 mm	Plastic, neon yellow	600-321-10	1 piece
7.5 mm	= 0.8 mm	Plastic, neon yellow	600-321-30	10 pieces
7.5 mm	= 0.8 mm	Plastic, neon yellow	600-321-60	100 pieces



CE

→ 11 mm →

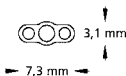

Expansion screws

Standard expansion screws



Expansion screw Maxi

Material: Stainless steel

- with **cone-shaped** expansion screw holder
 - skeleton design
 - holes in body of screws for better retention in acrylic
 - built-in stops prevent screws from coming apart
- With expansion screw key straight, small – standard.

Indication: for transverse expansion in the maxilla

Maximum expansion	4 x 1/4 turn	Directional arrow	REF	Quantity
7.5 mm	= 0.8 mm	Plastic, neon yellow	600-302-10	1 piece
7.5 mm	= 0.8 mm	Plastic, neon yellow	600-302-30	10 pieces
7.5 mm	= 0.8 mm	Plastic, neon yellow	600-302-60	100 pieces

CE

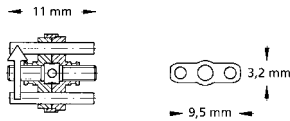

Expansion screw Maxi

Material: Stainless steel

- with **wide** expansion screw holder
 - skeleton design
 - holes in body of screws for better retention in acrylic
 - built-in stops prevent screws from coming apart
- With expansion screw key straight, small – standard.

Indication: for transverse expansion in the maxilla

Maximum expansion	4 x 1/4 turn	Directional arrow	REF	Quantity
7.5 mm	= 0.8 mm	Plastic, neon yellow	600-322-10	1 piece
7.5 mm	= 0.8 mm	Plastic, neon yellow	600-322-30	10 pieces
7.5 mm	= 0.8 mm	Plastic, neon yellow	600-322-60	100 pieces

CE

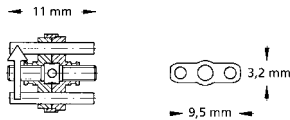

Expansion screw Magnum

Material: Stainless steel

- with **cone-shaped** expansion screw holder
 - skeleton design
 - version: extra strong, with larger screw body
 - holes in body of screws for better retention in acrylic
 - built-in stops prevent screws from coming apart
- With expansion screw key straight, small – standard.

Indication: for transverse expansion in the maxilla and bimaxillary functional gnatho-orthopedic appliances

Maximum expansion	4 x 1/4 turn	Directional arrow	REF	Quantity
11.0 mm	= 0.8 mm	Plastic, neon yellow	600-303-10	1 piece
11.0 mm	= 0.8 mm	Plastic, neon yellow	600-303-30	10 pieces
11.0 mm	= 0.8 mm	Plastic, neon yellow	600-303-60	100 pieces

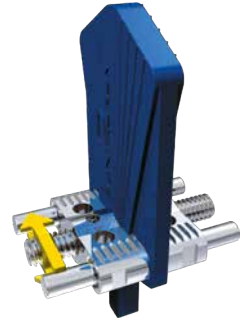

CE

→ 14,5 mm →

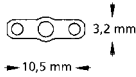
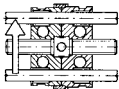

rematitan® expansion screw Medium

Material: Titanium

- with **cone-shaped** expansion screw holder
 - skeleton design
 - holes in body of screws for better retention in acrylic
 - built-in stops prevent screws from coming apart
- With expansion screw key straight, small – standard.

Indication: for transverse expansion and distalization in maxilla and mandible

Maximum expansion	4 x 1/4 turn	Directional arrow	REF	Quantity
7.5 mm	= 0.8 mm	Plastic, pearl-blue	600-400-10	1 piece
7.5 mm	= 0.8 mm	Plastic, pearl-blue	600-400-30	10 pieces



CE

→ 11 mm →

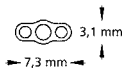

Expansion screws

Standard expansion screws



Trapezoidal expansion screw

Material: Stainless steel

- with **cone-shaped** expansion screw holder
 - skeleton design
 - holes in body of screws for better retention in acrylic
 - built-in stops prevent screws from coming apart
- With expansion screw key straight, small – standard.

Indication: for transverse expansion of narrow maxillae and as activation screw for bimaxillary functional gnatho-orthopedic appliances

Maximum expansion	4 x $\frac{1}{4}$ turn	Directional arrow	REF	Quantity
7.5 mm	= 0.8 mm	Plastic, neon yellow	600-310-30	10 pieces

CE

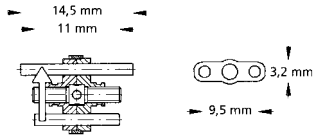

Sectional screw Mini

Material: Stainless steel

- with **wide** expansion screw holder
- skeleton design
- guide pins: U-shaped, **straight**

With expansion screw key straight, small – standard.

Indication: for movement of individual teeth

Maximum expansion	4 x 1/4 turn	Directional arrow	REF	Quantity
4.0 mm	= 0.35 mm	printed, blue-yellow	600-502-10	1 piece
4.0 mm	= 0.35 mm	printed, blue-yellow	600-502-30	10 pieces
4.0 mm	= 0.35 mm	printed, blue-yellow	600-502-60	100 pieces



CE

← 9,5 mm →

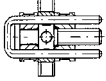

Sectional screw Mini

Material: Stainless steel

- with **wide** expansion screw holder
- skeleton design
- guide pins: U-shaped, **angulated facing down**

With expansion screw key straight, small – standard.

Indication: for movement of individual teeth

Maximum expansion	4 x 1/4 turn	Directional arrow	REF	Quantity
4.0 mm	= 0.35 mm	printed, blue-yellow	600-503-10	1 piece
4.0 mm	= 0.35 mm	printed, blue-yellow	600-503-30	10 pieces
4.0 mm	= 0.35 mm	printed, blue-yellow	600-503-60	100 pieces



CE

← 9,5 mm →

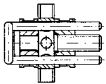

Expansion screws

Special expansion screws

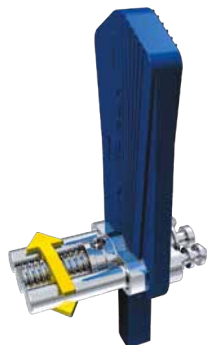

Sectional screw Medium

Material: Stainless steel

- with **cone-shaped** expansion screw holder
- skeleton design
- guide pins: **straight**, with mushroom head retention
- holes in body of screws for better retention in acrylic
- built-in stops prevent screws from coming apart

With expansion screw key straight, small – standard.

Indication: for distalization and segmentation of appliances, Y plates

Maximum expansion	4 x 1/4 turn	Directional arrow	REF	Quantity
6.0 mm	= 0.4 mm	Plastic, neon yellow	600-500-10	1 piece
6.0 mm	= 0.4 mm	Plastic, neon yellow	600-500-30	10 pieces
6.0 mm	= 0.4 mm	Plastic, neon yellow	600-500-60	100 pieces

CE

→ 12,5 mm ←

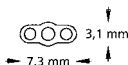

Sectional screw Medium

Material: Stainless steel

- with **cone-shaped** expansion screw holder
- skeleton design
- guide pins: U-shaped, **angulated facing down**
- holes in body of screws for better retention in acrylic
- With expansion screw key straight, small – standard.

Indication: for distalization and segmentation of appliances, protrusion of an anterior segment

Maximum expansion	4 x 1/4 turn	Directional arrow	REF	Quantity
6.0 mm	= 0.4 mm	Plastic, neon yellow	600-501-10	1 piece
6.0 mm	= 0.4 mm	Plastic, neon yellow	600-501-30	10 pieces
6.0 mm	= 0.4 mm	Plastic, neon yellow	600-501-60	100 pieces

CE

→ 13 mm ←

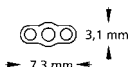
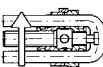

Retraction screw Extra Mini

Material: Stainless steel

- with **cone-shaped** expansion screw holder
- screw body: closed
- guide pins: U-shaped, straight

With expansion screw key straight, small – standard.

Indication: for space closing and movement of individual teeth

Maximum retraction	4 x 1/4 turn	Directional arrow	REF	Quantity
3.0 mm	= 0.4 mm	printed, blue-yellow	600-602-30	10 pieces

CE

← 13,5 mm →

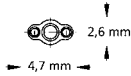
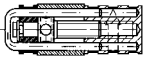

Retraction screw Mini

Material: Stainless steel

- with **cone-shaped** expansion screw holder
- screw body: closed
- guide pins: U-shaped, straight

With expansion screw key straight, small – standard.

Indication: for space closing and movement of individual teeth

Maximum retraction	4 x 1/4 turn	Directional arrow	REF	Quantity
2.5 mm	= 0.4 mm	printed, blue-yellow	600-601-30	10 pieces

CE

← 13 mm →

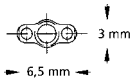
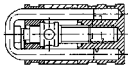

Expansion screws

Special expansion screws



Retraction screw Medium

Material: Stainless steel

- with **cone-shaped** expansion screw holder
- screw body: closed
- guide pins: U-shaped, straight

With expansion screw key straight, small – standard.

Indication: for space closing and movement of individual teeth

Maximum retraction	4 x 1/4 turn	Directional arrow	REF	Quantity
4.5 mm	= 0.4 mm	printed, blue-yellow	600-600-30	10 pieces

CE

← 17 mm →

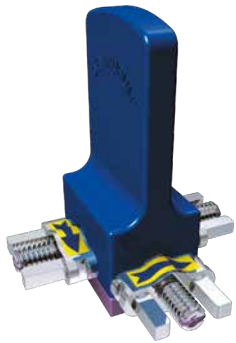
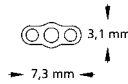
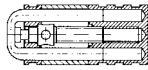

Three dimensional screw acc. to Bertoni – three movements (Type A)

Material: Stainless steel

- strengthened guides
- three independently controlled movements
- same total expansion per segment

With expansion screw key straight, small – standard.

Indication: for combined transverse and protrusion movements with Y plates

Maximum expansion	4 x 1/4 turn	Directional arrow	REF	Quantity
4.0 mm/segment	= 0.35 mm/segment	printed, blue-yellow	602-605-10	1 piece

CE

← 16 mm →

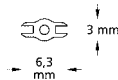
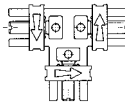

Three dimensional screw acc. to Bertoni – two movements (Type B)

Material: Stainless steel

- strengthened guides
- two independently controlled movements (symmetrical transverse expansion)
- same total expansion per segment

With expansion screw key straight, small – standard.

Indication: for combined transverse and protrusion movements with Y plates

Maximum expansion	4 x 1/4 turn	Directional arrow	REF	Quantity
4.0 mm/segment	= 0.35 mm/segment	printed, blue-yellow	602-606-10	1 piece

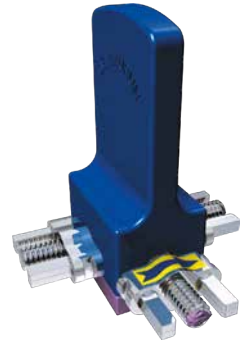

CE

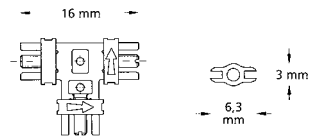

Three dimensional screw acc. to Steiner

Material: Stainless steel

- strengthened guides
- individually adjustable middle bar for adapting to different palatal vault curvatures
- two independently controlled movements (symmetrical transverse expansion)
- same total expansion per segment

With expansion screw key straight, small – standard.

Indication: for combined transverse and protrusion movements with Y plates

Maximum expansion	4 x 1/4 turn	Directional arrow	REF	Quantity
4.0 mm/segment	= 0.35 mm/segment	printed, blue-yellow	602-604-10	1 piece

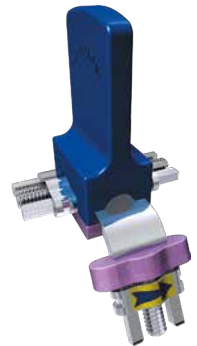

CE

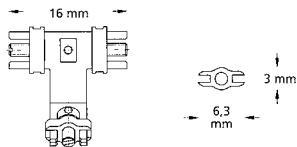

Expansion screws

Special expansion screws



Fan-type expansion screw

Material: Stainless steel

- with **wide** expansion screw holder
- plate sections are opened fanwise

With expansion screw key straight, small – standard.

Indication: for maxillary anterior or posterior expansion

Maximum expansion	4 x 1/4 turn	Directional arrow	REF	Quantity
7.0 mm	= 0.8 mm	printed, blue-yellow	606-600-00	1 piece
7.0 mm	= 0.8 mm	printed, blue-yellow	606-600-30	10 pieces

CE

← 12 mm →



Mandibular bow screw acc. to Müller

Material: Stainless steel

- with **cone-shaped** expansion screw holder
 - minimal fan-type opening of the arch screw, according to the anterior arch
- With expansion screw key straight, small – standard.

Indication: for transverse expansion of the mandibular anterior arch

Maximum expansion	4 x 1/4 turn	Directional arrow	REF	Quantity
5.0 mm	= 0.8 mm	Plastic, neon yellow	606-701-00	1 piece
5.0 mm	= 0.8 mm	Plastic, neon yellow	606-701-30	10 pieces

CE

← 20 mm →

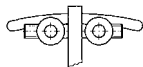

Flexible forward thrust double plate system acc. to Schaneng

Material: Stainless steel

- flexibility of the intermaxillary element
- screws with guide ridge for forward thrust double plate. Double loop, wax coated

With expansion screw key straight, small – standard.

Indication: for treatment of Angle Class II/1 (distocclusion), for advancement of the mandible

REF 600-000-00	1 assortment
CE	Contents:
3 x Screws with guide ridge for forward thrust double plate	REF 600-001-00
1 x Adapter, narrow	REF 600-003-00
1 x Adapter, wide	REF 600-004-00
1 x Locating template	REF 600-005-00

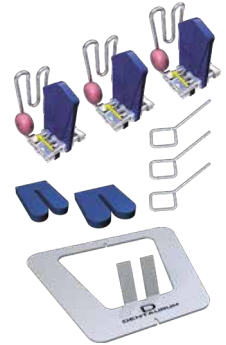

Guide ridge for flexible forward thrust double plate system acc. to Schaneng

With double loop, wax coated.

Material: stainless steel

Length of guide ridge: 14.0 mm

Version	REF	Quantity	REF	Quantity
with palatal expansion screw	600-001-00	1 piece	600-001-30	10 pieces
without palatal expansion screw	600-002-00	1 piece	600-002-30	10 pieces

CE



Guide ridge adapter for flexible forward thrust double plate system acc. to Schaneng

To produce the diagonal level in the mandibular.

Adapter	Width	REF	Quantity
narrow	14.0 mm	600-003-00	10 pieces
wide	18.0 mm	600-004-00	10 pieces



Locating template acc. to Schaneng

The locating template supplied with the system ensures that the guide ridge slides properly on the lingual plate at a 60° angle.

Material: stainless steel

REF 600-005-00	1 piece
----------------	---------



Expansion screws

Special expansion screws



Expansion screw for split activator

Material: Stainless steel

- with **cone-shaped** expansion screw holder
- strengthened guides

With expansion screw key straight, small – standard.

Indication: for separate expansion of maxilla and mandible

Maximum expansion	4 x 1/4 turn	Directional arrow	REF	Quantity
7.0 mm	= 0.8 mm	printed, blue-yellow	600-610-00	1 piece
7.0 mm	= 0.8 mm	printed, blue-yellow	600-610-30	10 pieces

CE

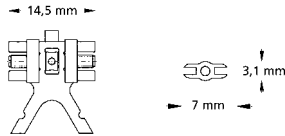

Expansion screw for progenia activator acc. to Weise

Material: Stainless steel

- without expansion screw holder
 - for fabricating horizontally split activators, which allow connection and shifting of both split planes
 - stable connection of the maxillary plate with the mandibular plate using a strong U-shaped bar
- With expansion screw key straight, small – standard.

Indication: for the treatment of Angle Class III (progenia), for distal shifting of the mandible

Maximum expansion	4 x 1/4 turn	Directional arrow	REF	Quantity
5.0 mm	= 0.9 mm	printed, blue-yellow	603-000-00	1 piece

CE

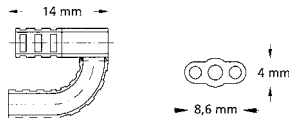

Piston spring screws assortment

Material: Stainless steel

- delicate design
- constant, elastic and easily controllable pressure on the tooth to be moved
- a protrusion of up to 7 mm can be attained according to the progress of treatment using three different lengths of screws (4 / 6 / 8 mm)

Indication: for movement of individual teeth

4 x 1/4 turn = 0.35 mm

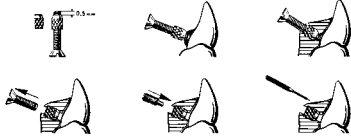

REF 609-500-00	1 assortment
CE	
Contents:	
10 x Piston spring screws, length 4 mm	REF 609-004-00
10 x Piston spring screws, length 6 mm	REF 609-006-00
10 x Piston spring screws, length 8 mm	REF 609-008-00
10 x Positioning screws	REF 609-100-00
10 x Serrated housing nuts	REF 609-200-30
1 x Reamer	REF 609-300-00
1 x Screwdriver	REF 609-400-00



Piston spring screw

Material: Stainless steel

- delicate design
- constant, elastic and easily controllable pressure on the tooth to be moved

Indication: for movement of individual teeth

Length	4 x 1/4 turn	REF	Quantity
4.0 mm	= 0.35 mm	609-004-00	10 pieces
6.0 mm	= 0.35 mm	609-006-00	10 pieces
8.0 mm	= 0.35 mm	609-008-00	10 pieces



CE

Positioning screw

For piston spring screw.

To position the piston spring screw into the acrylic.

Material: stainless steel

Length	REF	Quantity
12.0 mm	609-100-00	10 pieces



Serrated housing nut

For piston spring screw.

To position into acrylic or to weld onto wire elements.

Material: stainless steel

Length	REF	Quantity
3.0 mm	609-200-30	10 pieces



CE

Expansion screws

Special expansion screws



Reamer

For piston spring screw.

Material: stainless steel

REF 609-300-00	1 piece
----------------	---------



Screwdriver

For piston spring screw.

To activate the piston spring screws.

Material: stainless steel

REF 609-400-00	1 piece
----------------	---------

Variety click Mini – 8

Monoguided special expansion screw with click feature to prevent unwanted reversing. Primarily for treatment of malocclusions in the mandible using fixed appliances, e.g. for distalization, mesialization or for space closure by moving individual teeth. Also for early palatal expansion.

- optimal screw locking during the active treatment phase
 - small dimensions with maximum expansion
 - reliable activation/deactivation of the screw with clearly perceptible click after a $\frac{1}{4}$ turn
 - break resistant retention legs and stable guidance throughout the entire expansion
 - permanently laser marked arrow on the body of the screw indicates the opening direction and max. expansion
- Pack (1 piece) with 1 safety key, pack (10 pieces) with 10 safety keys.

Assembly dimension: 12.9 mm

Screw body: 9.6 mm

Maximum expansion: 8.0 mm

4 x $\frac{1}{4}$ turn = 0.8 mm

Material: stainless steel

Retention legs	REF	Quantity	REF	Quantity
without	602-836-12	1 piece	602-836-32	10 pieces
straight	602-836-10	1 piece	602-836-30	10 pieces

CE 0483

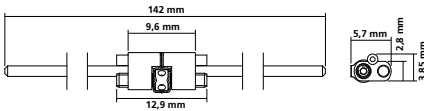

NEW

Variety click SP (small palate) Mini – 8

Monoguided special expansion screw with click feature to prevent unwanted reversing. For the fixed appliance technique. Can be widely used in the upper and lower jaw, for distalization, mesialization of posterior teeth, or for space closure by moving individual teeth. Also for early palatal expansion.

- optimal screw locking during the active treatment phase
 - especially suitable for very narrow jaws
 - retention legs can be bent very close to the screw body
 - small dimensions with maximum expansion
 - reliable activation/deactivation of the screw with clearly perceptible click after a $\frac{1}{4}$ turn
 - break resistant retention legs and stable guidance throughout the entire expansion
 - permanently laser marked arrow on the body of the screw indicates the opening direction and max. expansion
- Pack (1 piece) with 1 safety key, pack (10 pieces) with 10 safety keys.

Assembly dimension: 12.9 mm

Screw body: 9.6 mm

Maximum expansion: 8.0 mm

4 x $\frac{1}{4}$ turn = 0.8 mm

Material: stainless steel

Retention legs	REF	Quantity	REF	Quantity
without	602-838-12	1 piece	602-838-32	10 pieces
straight	602-838-10	1 piece	602-838-30	10 pieces

CE 0483

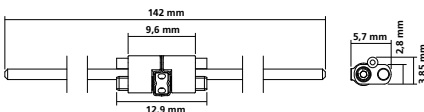

NEW

Expansion screws

Variety expansion screws



Variety click Maxi – 12

Monoguided special expansion screw with click feature to prevent unwanted reversing. Primarily for treatment of malocclusions in the mandible using fixed appliances, e.g. for distalization, mesialization or for space closure by moving individual teeth. Also for early palatal expansion.

- optimal screw locking during the active treatment phase
- small dimensions with maximum expansion
- reliable activation/deactivation of the screw with clearly perceptible click after a $\frac{1}{4}$ turn
- break resistant retention legs and stable guidance throughout the entire expansion
- permanently laser marked arrow on the body of the screw indicates the opening direction and max. expansion

Pack (1 piece) with 1 safety key, pack (10 pieces) with 10 safety keys.

Assembly dimension: 17.2 mm

Screw body: 9.6 mm

Maximum expansion: 12.0 mm

$4 \times \frac{1}{4}$ turn = 0.8 mm

Material: stainless steel

NEW

Retention legs	REF	Quantity	REF	Quantity
without	602-837-12	1 piece	602-837-32	10 pieces
straight	602-837-10	1 piece	602-837-30	10 pieces

CE 0483

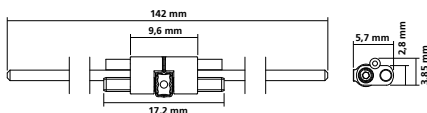

Variety click SP (small palate) Maxi – 12

Monoguided special expansion screw with click feature to prevent unwanted reversing. For treatment of malocclusions in the mandible using fixed appliances, e.g. for distalization, mesialization or for space closure by moving individual teeth. Also for early palatal expansion.

- optimal screw locking during the active treatment phase
- especially suitable for very narrow jaws
- retention legs can be bent very close to the screw body
- small dimensions with maximum expansion
- reliable activation/deactivation of the screw with clearly perceptible click after a $\frac{1}{4}$ turn
- break resistant retention legs and stable guidance throughout the entire expansion
- permanently laser marked arrow on the body of the screw indicates the opening direction and max. expansion

Pack (1 piece) with 1 safety key, pack (10 pieces) with 10 safety keys.

Assembly dimension: 17.2 mm

Screw body: 9.6 mm

Maximum expansion: 12.0 mm

$4 \times \frac{1}{4}$ turn = 0.8 mm

Material: stainless steel

NEW

Retention legs	REF	Quantity	REF	Quantity
without	602-839-12	1 piece	602-839-32	10 pieces
straight	602-839-10	1 piece	602-839-30	10 pieces

CE 0483

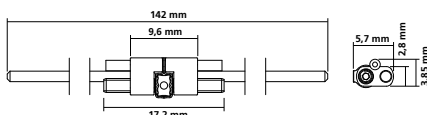

Variety Mini – 8

Monoguided special expansion screw. Primarily for treatment of malocclusions in the mandible using fixed appliances, e.g. for distalization, mesialization or for space closure by moving individual teeth. Also for early palatal expansion.

- small dimensions with maximum expansion
- break resistant retention legs and stable guidance throughout the entire expansion
- the integrated spindle friction prevents unwanted reversing
- permanently laser marked arrow on the body of the screw indicates the opening direction and max. expansion
- screw can be tied down once desired expansion has been reached

Pack (1 piece) with 1 safety key, pack (10 pieces) with 10 safety keys.

Assembly dimension: 12.9 mm

Screw body: 9.6 mm

Maximum expansion: 8.0 mm

4 x 1/4 turn = 0.8 mm

Material: stainless steel

Retention legs	REF	Quantity	REF	Quantity
without	602-815-12	1 piece	602-815-32	10 pieces
straight	602-815-10	1 piece	602-815-30	10 pieces

CE 0483

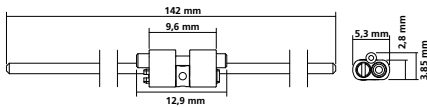

NEW

Variety SP (small palate) Mini – 8

Monoguided special expansion screw. For treatment of malocclusions in the mandible using fixed appliances, e.g. for distalization, mesialization or for space closure by moving individual teeth. Also for early palatal expansion.

- especially suitable for very narrow jaws
- retention legs can be bent very close to the screw body
- small dimensions with maximum expansion
- break resistant retention legs and stable guidance throughout the entire expansion
- the integrated spindle friction prevents unwanted reversing
- permanently laser marked arrow on the body of the screw indicates the opening direction and max. expansion
- screw can be tied down once desired expansion has been reached

Pack (1 piece) with 1 safety key, pack (10 pieces) with 10 safety keys.

Assembly dimension: 12.9 mm

Screw body: 9.6 mm

Maximum expansion: 8.0 mm

4 x 1/4 turn = 0.8 mm

Material: stainless steel

Retention legs	REF	Quantity	REF	Quantity
without	602-819-12	1 piece	602-819-32	10 pieces
straight	602-819-10	1 piece	602-819-30	10 pieces

CE 0483

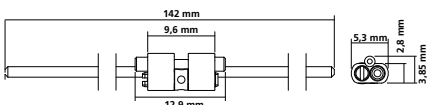

NEW

Expansion screws

Variety expansion screws



Variety Maxi – 12

Monoguided special expansion screw. Primarily for treatment of malocclusions in the mandible using fixed appliances, e.g. for distalization, mesialization or for space closure by moving individual teeth. Also for early palatal expansion.

- small dimensions with maximum expansion
 - break resistant retention legs and stable guidance throughout the entire expansion
 - the integrated spindle friction prevents unwanted reversing
 - permanently laser marked arrow on the body of the screw indicates the opening direction and max. expansion
 - screw can be tied down once desired expansion has been reached
- Pack (1 piece) with 1 safety key, pack (10 pieces) with 10 safety keys.

Assembly dimension: 14.9 mm

Screw body: 9.6 mm

Maximum expansion: 12.0 mm

4 x 1/4 turn = 0.8 mm

Material: stainless steel

NEW

Retention legs	REF	Quantity	REF	Quantity
without	602-806-12	1 piece	602-806-32	10 pieces
straight	602-806-10	1 piece	602-806-30	10 pieces

CE 0483

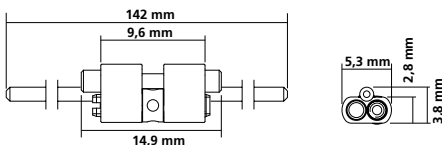

Variety SP (small palate) Maxi – 12

Monoguided special expansion screw. For treatment of malocclusions in the mandible using fixed appliances, e.g. for distalization, mesialization or for space closure by moving individual teeth. Also for early palatal expansion.

- especially suitable for very narrow jaws
- retention legs can be bent very close to the screw body
- small dimensions with maximum expansion
- break resistant retention legs and stable guidance throughout the entire expansion
- the integrated spindle friction prevents unwanted reversing
- permanently laser marked arrow on the body of the screw indicates the opening direction
- screw can be tied down once desired expansion has been reached

Pack (1 piece) with 1 safety key, pack (10 pieces) with 10 safety keys.

Assembly dimension: 14.9 mm

Screw body: 9.6 mm

Maximum expansion: 12.0 mm

4 x 1/4 turn = 0.8 mm

Material: stainless steel

NEW

Retention legs	REF	Quantity	REF	Quantity
without	602-809-12	1 piece	602-809-32	10 pieces
straight	602-809-10	1 piece	602-809-30	10 pieces

CE 0483

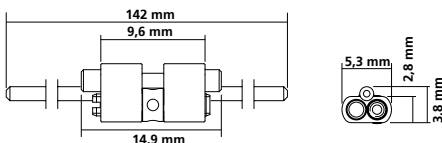

Titan hyrax® Maxi – 12

RPE screw of titanium

For rapid palatal expansion by means of fixed appliances.

The screw is anchored to the teeth using cast titanium and laser-welded cap splints or alternatively using acrylic cap splints fabricated from Orthocryl® acrylic.

Pack (1 piece) with 1 safety key, pack (10 pieces) with 10 safety keys.

Screw body: 14.4 mm

Maximum expansion: 12.0 mm

4 x 1/4 turn = 0.8 mm

Material: titanium



Retention legs	REF	Quantity	REF	Quantity
without	602-810-12	1 piece	602-810-32	10 pieces
straight	602-810-10	1 piece	602-810-30	10 pieces

NEW

CE 0483

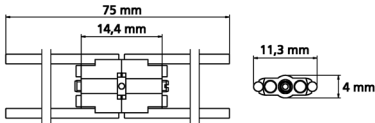

rematitan® straight wire

Titanium grade 1

Norm: DIN 17850

For laser welding.

Recommended as reinforcing wire for fixed titanium RPE appliances (Titan hyrax® Maxi – 12).

ø	Length	REF	Quantity
1.00 mm / 39	each 100 mm	528-041-00	10 pieces
1.20 mm / 47	each 100 mm	528-042-00	10 pieces

CE 0483



DENTAURUM
ONLINE SHOP
shop.dentaurum.com



RPE screws



hyrax® click Mini – 7

RPE screw with click feature to prevent unwanted reversing

For effective and reliable rapid palatal expansion by means of fixed appliances.

- optimal screw locking during the active treatment phase
- built-in stops prevent the screws from coming apart once maximum expansion has been obtained
- reliable activation/deactivation of the screw with clearly perceptible click after a $\frac{1}{4}$ turn
- no accidental reversing when pulling out safety key during activation
- minimal dimensions with maximum expansion range
- permanently laser marked arrow on the body of the screw indicates the opening direction and max. expansion

Pack (1 piece) with 1 safety key, pack (10 pieces) with 10 safety keys.

Screw body: 9.8 mm

Maximum expansion: 7.0 mm

4 x $\frac{1}{4}$ turn = 0.8 mm

Material: stainless steel

Retention legs	REF	Quantity	REF	Quantity
without	602-830-12	1 piece	602-830-32	10 pieces
straight	602-830-10	1 piece	602-830-30	10 pieces
angulated	602-831-10	1 piece	602-831-30	10 pieces

CE 0483

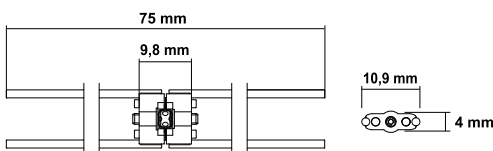

hyrax® click Medium – 10

RPE screw with click feature to prevent unwanted reversing

For effective and reliable rapid palatal expansion by means of fixed appliances.

- optimal screw locking during the active treatment phase
- built-in stops prevent the screws from coming apart once maximum expansion has been obtained
- reliable activation/deactivation of the screw with clearly perceptible click after a $\frac{1}{4}$ turn
- no accidental reversing when pulling out safety key during activation
- minimal dimensions with maximum expansion range
- permanently laser marked arrow on the body of the screw indicates the opening direction and max. expansion

Pack (1 piece) with 1 safety key, pack (10 pieces) with 10 safety keys.

Screw body: 12.8 mm

Maximum expansion: 10.0 mm

4 x $\frac{1}{4}$ turn = 0.8 mm

Material: stainless steel

Retention legs	REF	Quantity	REF	Quantity
without	602-832-12	1 piece	602-832-32	10 pieces
straight	602-832-10	1 piece	602-832-30	10 pieces
angulated	602-833-10	1 piece	602-833-30	10 pieces

CE 0483

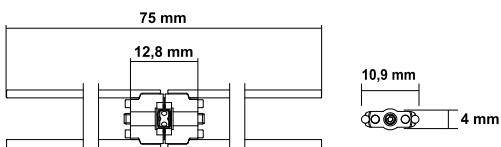

hyrax® click Maxi – 12

RPE screw with click feature to prevent unwanted reversing

For effective and reliable rapid palatal expansion by means of fixed appliances.

- optimal screw locking during the active treatment phase
- built-in stops prevent the screws from coming apart once maximum expansion has been obtained
- reliable activation/deactivation of the screw with clearly perceptible click after a $\frac{1}{4}$ turn
- no accidental reversing when pulling out safety key during activation
- minimal dimensions with maximum expansion range
- permanently laser marked arrow on the body of the screw indicates the opening direction and max. expansion

Pack (1 piece) with 1 safety key, pack (10 pieces) with 10 safety keys.

Screw body: 14.8 mm

Maximum expansion: 12.0 mm

4 x $\frac{1}{4}$ turn = 0.8 mm

Material: stainless steel



NEW

Retention legs	REF	Quantity	REF	Quantity
without	602-834-12	1 piece	602-834-32	10 pieces
straight	602-834-10	1 piece	602-834-30	10 pieces
angulated	602-835-10	1 piece	602-835-30	10 pieces

CE 0483

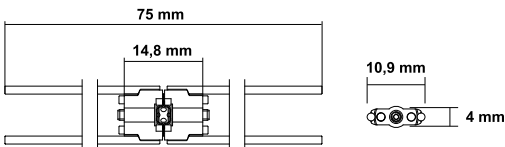

Expansion screws

RPE screws



hyrax® Mini – 7

RPE screw

For rapid palatal expansion by means of fixed appliances.

- built-in stops prevent the screws from coming apart once maximum expansion has been obtained
 - small dimensions with maximum expansion
 - break resistant retention legs, stable guidance throughout complete expansion
 - the integrated spindle friction prevents unwanted reversing
 - permanently laser marked arrow on the body of the screw indicates the opening direction and max. expansion
 - screw can be tied down once desired expansion has been reached
- Pack (1 piece) with 1 safety key, pack (10 pieces) with 10 safety keys.

Screw body: 9.4 mm

Maximum expansion: 7.0 mm

4 x 1/4 turn = 0.8 mm

Material: stainless steel

Retention legs	REF	Quantity	REF	Quantity
without	602-800-12	1 piece	602-800-32	10 pieces
straight	602-800-10	1 piece	602-800-30	10 pieces
angulated	602-801-10	1 piece	602-801-30	10 pieces

CE 0483

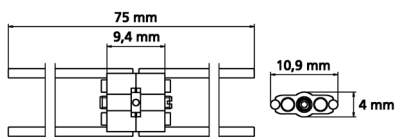

hyrax® Medium – 10

RPE screw

For rapid palatal expansion by means of fixed appliances.

- built-in stops prevent the screws from coming apart once maximum expansion has been obtained
 - small dimensions with maximum expansion
 - break resistant retention legs, stable guidance throughout complete expansion
 - offset body for earliest possible angling of the retention legs
 - the integrated spindle friction prevents unwanted reversing
 - permanently laser marked arrow on the body of the screw indicates the opening direction and max. expansion
 - screw can be tied down once desired expansion has been reached
- Pack (1 piece) with 1 safety key, pack (10 pieces) with 10 safety keys.

Screw body: 12.4 mm

Maximum expansion: 10.0 mm

4 x 1/4 turn = 0.8 mm

Material: stainless steel

Retention legs	REF	Quantity	REF	Quantity
without	602-808-12	1 piece	602-808-32	10 pieces
straight	602-808-10	1 piece	602-808-30	10 pieces
angulated	602-840-10	1 piece	602-840-30	10 pieces

CE 0483

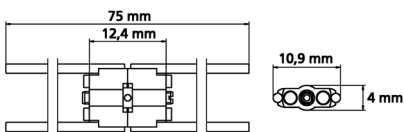

NEW

hyrax® Maxi – 12

RPE screw

For rapid palatal expansion by means of fixed appliances.

- the retention legs can be angled near to the screw body
 - built-in stops prevent the screws from coming apart once maximum expansion has been obtained
 - break resistant retention legs, stable guidance throughout complete expansion
 - offset body for earliest possible angling of the retention legs
 - the integrated spindle friction prevents unwanted reversing
 - permanently laser marked arrow on the body of the screw indicates the opening direction and max. expansion
 - screw can be tied down once desired expansion has been reached
- Pack (1 piece) with 1 safety key, pack (10 pieces) with 10 safety keys.

Screw body: 14.4 mm

Maximum expansion: 12.0 mm

4 x 1/4 turn = 0.8 mm

Material: stainless steel

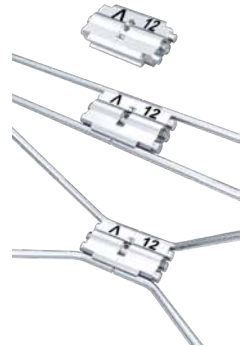

NEW

Retention legs	REF	Quantity	REF	Quantity
without	602-811-12	1 piece	602-811-32	10 pieces
straight	602-811-10	1 piece	602-811-30	10 pieces
angulated	602-812-10	1 piece	602-812-30	10 pieces

CE 0483

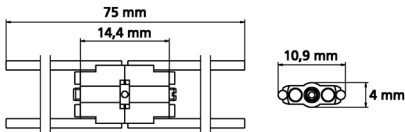

Expansion screws

Accessories



Arrow to indicate the opening direction

For expansion screws.

Color	REF	Quantity
yellow	611-130-00	50 pieces
white	611-131-00	50 pieces
pearl-blue	611-132-00	50 pieces

CE



Universal bending key

Easy bending of the retention legs of all Hyrax® and Variety screws without using any additional pliers (leverage principle).
Material: stainless steel

REF 611-122-00	1 piece
----------------	---------



Safety key

Can be used with all Dentaurum Hyrax® and Variety screws.
For safe intra-oral activation of the expansion screws in fixed appliances.

REF 611-120-01	10 pieces
----------------	-----------

CE



Expansion screw key straight, small – standard

Can be used with all Dentaurum expansion screws.
To activate all expansion screws in removable appliances (Outside of the mouth).
Material: stainless steel

REF 611-115-00	1 piece
REF 611-115-30	10 pieces
REF 611-115-60	100 pieces



Expansion screw key large – with elongated handle

Can be used with all Dentaurum expansion screws.
To activate all expansion screws in removable appliances (Outside of the mouth).
Material: stainless steel

REF 611-116-00	1 piece
----------------	---------



Expansion screw sample kit

Includes a selection of expansion screws from Dentaurum's large range of expansion screws.
Filled with 27 expansion screws that are also available separately, 2 expansion screw keys and 1 universal bending key. **1 set = 30 pieces.**

REF 612-000-00	1 set
----------------	-------

CE 0483

Wedge gauge

For checking the gap width on palatal expanders.

REF 043-720-00

1 piece



Orthocryl® LC / Starter sets	Page	332
Orthocryl® LC / Single packs	Page	333
Orthocryl® LC / Accessories	Page	334
Orthocryl® / Assortments	Page	335
Orthocryl® / Single packs	Page	336
Disco glitter	Page	338
Decals	Page	339
Accessories	Page	343
Appliance containers and accessories	Page	348



Orthodontic acrylics.

Vibrant colors – fascinating varieties.

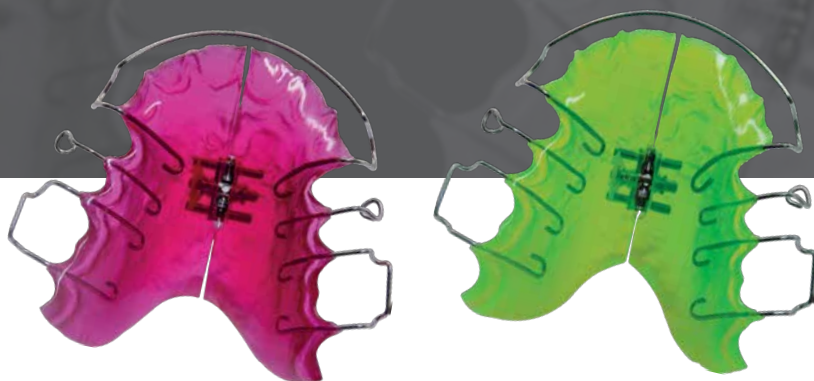

DENTAU RUM
**ONLINE
SHOP**
shop.dentaurum.com



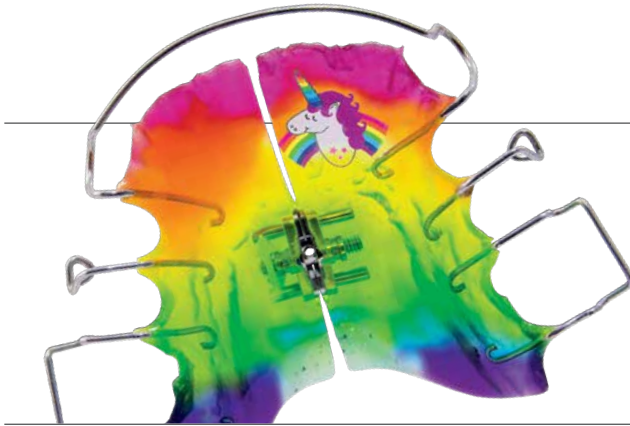

The versatile acrylic system.

Orthocryl® has been a fixture in orthodontic laboratories for more than 55 years. For generations, it has combined excellent product characteristics and easy handling.

There are no limits to your creativity, regardless of whether you choose black, white or multi-color – Orthocryl® offers maximum freedom in design with its variety of lively colors, glitter and decals. Apart from the conventional cold-curing acrylic, Orthocryl® is also available as light-curing material. Orthocryl® LC is especially designed to meet the requirements for fabricating orthodontic appliances. It is light-curing, time-saving and easy to use.

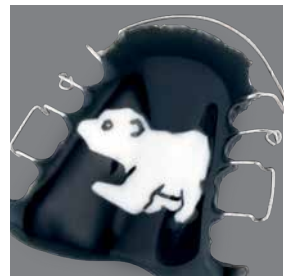
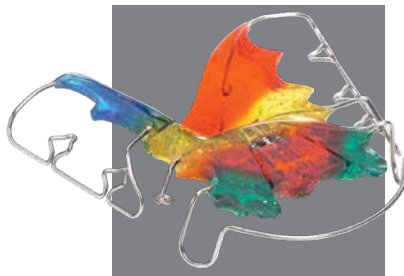

Orthocryl® LC

The light-curing acrylic.

Orthocryl®

Suited for the salt-and-pepper technique.

Orthocryl® Neon

Vivid colors.

Orthocryl® EQ

Suited for the doughing technique.

Orthocryl® black & white

High-contrast, versatile.

A wide range of field-proven accessories

All from one source.



Orthocryl® LC



The light-curing acrylic for orthodontists.

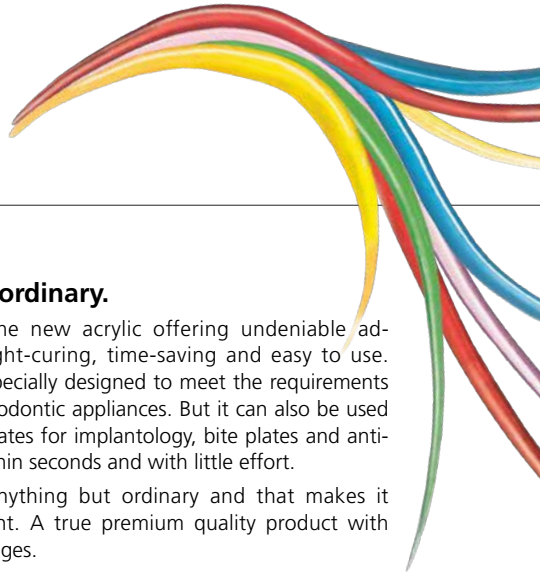

Anything but ordinary.

Orthocryl® LC is the new acrylic offering undeniable advantages – it is light-curing, time-saving and easy to use. Orthocryl® LC is especially designed to meet the requirements for fabricating orthodontic appliances. But it can also be used to make drill templates for implantology, bite plates and anti-snoring devices within seconds and with little effort.

Orthocryl® LC is anything but ordinary and that makes it delightfully different. A true premium quality product with undeniable advantages.

Advantages:

- Extremely easy to use.
- Saves time and material.
- Optimal flowability.
- Wide range of applications.
- Completely odorless.
- Biocompatible.



Easy to use and flexible.

Orthocryl® LC is extremely easy to use. The product is delivered ready to use in black, opaque cartridges. Time-consuming preparation steps have become superfluous: the acrylic does not have to be doughed or salt-and-peppered anymore.

The material can be directly applied from the cartridge to the prepared model. The application injector helps to apply the right dosage in the right spot. The easy handling saves both a great amount of time when processing and finishing the appliance and a lot of material.

Due to its optimal flowability, Orthocryl® LC can be easily adapted to the plaster model.

Orthocryl® LC is available in six vibrant colors. Adding Disco glitter or decals from the extensive Orthocryl® program makes each appliance unique.



Orthodontic acrylics

Orthocryl® LC / Starter sets



Orthocryl® LC starter set

Light-curing acrylic.

REF 160-400-00	1 assortment
----------------	--------------

CE 0483

Contents:

1 x Orthocryl® LC, clear	REF 160-401-00
1 x Orthocryl® LC, transparent pink	REF 160-402-00
1 x Orthocryl® LC, red	REF 160-403-00
1 x Orthocryl® LC, blue	REF 160-404-00
1 x Orthocryl® LC, yellow	REF 160-405-00
1 x Orthocryl® LC, green	REF 160-406-00
1 x Injector for Orthocryl® LC	REF 160-420-00
50 x Cartridge tips for Orthocryl® LC	REF 160-421-00



Orthocryl® LC starter set, clear

Light-curing acrylic.

REF 160-400-20	1 assortment
----------------	--------------

CE 0483

Contents:

6 x Orthocryl® LC, clear	REF 160-401-00
1 x Injector for Orthocryl® LC	REF 160-420-00
50 x Cartridge tips for Orthocryl® LC	REF 160-421-00

Orthocryl® LC

Light-curing acrylic in opaque cartridges.

Color	REF	Quantity
clear	160-401-00	30 g
transparent pink	160-402-00	30 g
red	160-403-00	30 g
blue	160-404-00	30 g
yellow	160-405-00	30 g
green	160-406-00	30 g



CE 0483



Orthodontic acrylics

Orthocryl® LC / Accessories



Bite paste

For Orthocryl® LC.

Color	REF	Quantity
transparent	160-410-00	50 g

CE 0483



Injector

For Orthocryl® LC.

REF 160-420-00	1 piece
----------------	---------



Cartridge tips

For Orthocryl® LC.

REF 160-421-00	50 pieces
----------------	-----------



Cleaning liquid

For Orthocryl® LC.

REF 160-430-00	100 ml
----------------	--------



Stand for cartridges

For Orthocryl® LC. Fits 6 cartridges.

Material: Plastic

Do not use disinfectants containing ethanol, phenol or alcohol.

Dimensions: ca. 170 x 110 x 110 mm (W x H x D)

Color	REF	Quantity
transparent, clear	160-422-00	1 piece



Separating medium

Special alginate-based separating agent that forms a thin, abrasive-resistant separating film.

Separates:

- plaster from acrylic
- plaster from plaster

Color	REF	Quantity
pink	162-800-00	1000 ml

Orthocryl® assortment

REF 161-912-00	1 assortment
CE 0483 Contents:	
1 kg Orthocryl® powder (polymer), clear	REF 160-112-00
500 ml Orthocryl® liquid (monomer), clear	REF 161-100-00
1000 ml Separating medium	REF 162-800-00
2 x Spray bottle	REF 162-100-00
1 x Measuring beaker	REF 162-200-00
1 x Funnel	REF 162-600-00
1 x Spray nozzle for powder (polymer)	REF 162-751-00
1 x Spray nozzle for liquid (monomer)	REF 162-752-00



Orthocryl® Small pack powder (polymer) and liquid (monomer)

Color	REF	Quantity
transparent pink	160-501-00	200 g + 100 ml
clear	160-502-00	200 g + 100 ml

CE 0483



Orthocryl® assortment “The multicolored palette”

REF 160-600-00	1 assortment
CE 0483 Contents:	
1 kg Orthocryl® powder (polymer), clear	REF 160-112-00
250 ml Orthocryl® liquid (monomer), red	REF 161-127-00
250 ml Orthocryl® liquid (monomer), green	REF 161-128-00
250 ml Orthocryl® liquid (monomer), blue	REF 161-129-00
250 ml Orthocryl® liquid (monomer), yellow	REF 161-130-00
1 x Funnel	REF 162-600-00



Orthocryl® Neon assortment Brightly colored orthodontic acrylics Liquid (monomer)

Neon-colored Orthocryl® liquid (monomer) for producing brightly colored orthodontic appliances. Cold curing acrylic resin permitting the simple and economical fabrication of orthodontic appliances. Easy processing, using both the doughing and the salt-and-pepper technique in conjunction with the clear Orthocryl® powder (polymer, REF 160-112-00/160-212-00). Disco glitter can also be used to enhance the effect of the colors.

REF 160-700-00	1 assortment
CE 0483 Contents:	
1 kg Orthocryl® powder (polymer), clear	REF 160-112-00
250 ml Orthocryl® liquid (monomer), neon yellow	REF 161-135-00
250 ml Orthocryl® liquid (monomer), neon orange	REF 161-136-00
250 ml Orthocryl® liquid (monomer), neon pink	REF 161-137-00
250 ml Orthocryl® liquid (monomer), neon green	REF 161-138-00
1 x Funnel	REF 162-600-00



NEW

Orthocryl® acrylics

Orthocryl® / Single packs



Orthocryl®

Powder (polymer)

Cold curing acrylic resin permitting the simple and economical fabrication of orthodontic appliances.

Especially suited for the salt-and-pepper technique.

Also, very suitable for the doughing technique.

Color	REF	Quantity	REF	Quantity
clear	160-112-00	1 kg	160-212-00	10 kg

CE⁰⁴⁸³



Orthocryl® EQ

Powder (polymer)

Cold curing acrylic resin permitting the simple and economical fabrication of orthodontic appliances.

Especially suited for the doughing technique.

Also, very suitable for the salt-and-pepper technique.

Color	REF	Quantity	REF	Quantity
clear	160-300-00	1 kg	160-301-00	10 kg

CE⁰⁴⁸³



Orthocryl® black & white

Powder (polymer), opaque

Cold curing acrylic resin permitting the simple and economical fabrication of orthodontic appliances.

Especially suited for the salt-and-pepper technique.

Also, very suitable for the doughing technique.

Color	REF	Quantity	REF	Quantity
black	160-011-00	200 g	160-013-00	1 kg
white	160-012-00	200 g	160-014-00	1 kg

CE⁰⁴⁸³



Orthocryl® Neon

Brightly colored orthodontic acrylics

Liquid (monomer)

Neon-colored Orthocryl® liquid (monomer) for producing brightly colored orthodontic appliances. Cold curing acrylic resin permitting the simple and economical fabrication of orthodontic appliances. Easy processing, using both the doughing and the salt-and-pepper technique in conjunction with the clear Orthocryl® powder (polymer, REF 160-112-00/160-212-00). Disco glitter can also be used to enhance the effect of the colors.

Color	REF	Quantity
neon yellow	161-135-00	250 ml
neon orange	161-136-00	250 ml
neon pink	161-137-00	250 ml
neon green	161-138-00	250 ml

CE⁰⁴⁸³

NEW

Orthocryl®

Liquid (monomer)

Cold curing acrylic resin permitting the simple and economical fabrication of orthodontic appliances.

Color	REF	Quantity	REF	Quantity	REF	Quantity
red	161-127-00	250 ml				
green	161-128-00	250 ml				
blue	161-129-00	250 ml				
yellow	161-130-00	250 ml				
turquoise	161-131-00	250 ml				
pink	161-132-00	250 ml				
emerald green	161-133-00	250 ml				
violet	161-134-00	250 ml				
clear			161-100-00	500 ml	161-150-00	1000 ml
transparent pink			161-300-00	500 ml	161-350-00	1000 ml



CE 0483

Orthocryl®

Color concentrate

For tinting clear Orthocryl® liquid (monomer, REF 161-100-00 / 161-150-00). With one dispensing pipette.

Color	Mixing ratio	REF	Quantity
red	1 : 10	161-620-00	100 ml
blue	1 : 50	161-622-00	100 ml



CE 0483

Mixing ratio:

	Liquid, clear	Color concentrate	Liquid, clear	Color concentrate
1 : 10 (red)	100 ml	10 ml	50 ml	5 ml
1 : 50 (blue)	100 ml	2 ml	50 ml	1 ml



Disco glitter



Orthocryl® Disco glitter

For coloring the removable appliances. The glitter is simply added as desired to the Orthocryl® powder (polymer) to give the appliance an attractive luster. No change in the processing of Orthocryl® is necessary. The appliances can be finished and polished without difficulty.

Mixing ratio:

0.5 : 100 (by volume glitter : powder)

Color	REF	Quantity
iris	161-605-00	50 g
red	161-606-00	50 g
blue	161-607-00	50 g
silver	161-608-00	50 g
gold	161-609-00	50 g
mother-of-pearl	161-611-00	50 g



Decals / Assortment

For placing in orthodontic appliances. For polymerizing into Orthocryl® acrylic, allowing removable orthodontic appliances to be fabricated to suit individual patient preferences.

Contents:

Assortment consists of 20 individual designs
20 pieces each = 400 pieces, plus tweezers.

REF 160-100-00	1 assortment
CE	
20 x Crocodile	REF 160-100-01
20 x Frog	REF 160-100-02
20 x Parrot	REF 160-100-04
20 x Ladybug	REF 160-100-05
20 x Dragon	REF 160-100-06
20 x Fish	REF 160-100-07
20 x Formula 1 (Indy Racecar)	REF 160-100-09
20 x Elephant	REF 160-100-10
20 x Heart	REF 160-100-11
20 x Duck	REF 160-100-12
20 x Dinosaur	REF 160-100-13
20 x Motorcycle	REF 160-100-14
20 x Snail	REF 160-100-15
20 x Teddybear	REF 160-100-16
20 x Mushrooms	REF 160-100-18
20 x Car	REF 160-100-19
20 x Raven	REF 160-100-27
20 x Devil	REF 160-100-29
20 x Soccer Player	REF 160-100-31
20 x Mouse	REF 160-100-45



Decal "Football"

Sheet with two different sizes of design

For placing in orthodontic appliances. For polymerizing into Orthocryl® acrylic, allowing removable orthodontic appliances to be fabricated to suit individual patient preferences.

Motif	REF	Quantity
Football	160-100-39	1 sheet = 20 pieces



CE

Decal "Beaver"

For placing in orthodontic appliances. For polymerizing into Orthocryl® acrylic, allowing removable orthodontic appliances to be fabricated to suit individual patient preferences.

Motif	REF	Quantity
Beaver	160-100-40	1 sheet = 20 pieces



CE

Decals "Black Edition"

For placing in orthodontic appliances. For polymerizing into Orthocryl® acrylic, allowing removable orthodontic appliances to be fabricated to suit individual patient preferences.

Motif	REF	Quantity
Black Edition	160-100-41	1 sheet = 12 designs



CE

Decals

Decals

For placing in orthodontic appliances. For polymerizing into Orthocryl® acrylic, allowing removable orthodontic appliances to be fabricated to suit individual patient preferences.



Motif	REF	Quantity
Hello Beaver	160-100-42	2 sheets = 20 pieces
Horse	160-100-43	2 sheets = 20 pieces
Pink Pony	160-100-44	2 sheets = 20 pieces
Unicorn	160-100-46	2 sheets = 20 pieces

CE

NEW

Decals

For placing in orthodontic appliances. For polymerizing into Orthocryl® acrylic, allowing removable orthodontic appliances to be fabricated to suit individual patient preferences.



Motif	REF	Quantity
Crocodile	160-100-01	20 pieces
Frog	160-100-02	20 pieces
Parrot	160-100-04	20 pieces

CE

Decals

For placing in orthodontic appliances. For polymerizing into Orthocryl® acrylic, allowing removable orthodontic appliances to be fabricated to suit individual patient preferences.

Motif	REF	Quantity
Ladybug	160-100-05	20 pieces
Dragon	160-100-06	20 pieces
Fish	160-100-07	20 pieces
Formula 1 (Indy Racecar)	160-100-09	20 pieces
Elephant	160-100-10	20 pieces
Heart	160-100-11	20 pieces
Duck	160-100-12	20 pieces
Dinosaur	160-100-13	20 pieces
Motorcycle	160-100-14	20 pieces
Snail	160-100-15	20 pieces



Decals

Decals

For placing in orthodontic appliances. For polymerizing into Orthocryl® acrylic, allowing removable orthodontic appliances to be fabricated to suit individual patient preferences.



Motif	REF	Quantity
Teddybear	160-100-16	20 pieces
Mushrooms	160-100-18	20 pieces
Car	160-100-19	20 pieces
Raven	160-100-27	20 pieces
Spider	160-100-28	20 pieces
Devil	160-100-29	20 pieces
Graffiti	160-100-30	20 pieces
Soccer Player	160-100-31	20 pieces
Mouse	160-100-45	20 pieces
Dolphin	160-100-34	20 pieces



Spray bottle

For powder (polymer) and liquid (monomer).

Capacity	REF	Quantity
100 ml	162-100-00	1 piece



Spray nozzle for Orthocryl® liquid (monomer)

Inner ø	Length	REF	Quantity
0.40 mm	10 mm	162-752-00	12 pieces



Spray nozzle for Orthocryl® powder (polymer)

REF 162-751-00	1 piece
----------------	---------



Mixing bowl made of silicone

Flexible, with suction base. For all mixing jobs in the practice and laboratory.

Do not use with silicone materials!

Capacity	REF	Quantity
5 ml	162-501-00	3 pieces
25 ml	162-502-00	1 piece
75 ml	162-503-00	1 piece



Spout

For Orthocryl® bottles (liquid/monomer, 250 ml, 500 ml, 1000 ml).

REF 162-750-01	1 piece
----------------	---------



Funnel

REF 162-600-00	1 piece
----------------	---------



Measuring beaker

REF 162-200-00	1 piece
----------------	---------



Accessories



Dispensing pipette

For Orthocryl® color concentrates.

REF 162-101-00

10 pieces



Separating medium

Special alginate-based separating agent that forms a thin, abrasive-resistant separating film.

Separates:

- plaster from acrylic
- plaster from plaster

Color	REF	Quantity
pink	162-800-00	1000 ml



Modeling wax

For acrylic work, construction bites etc.

- well adaptable
- very easy to model
- firm up to approx. 37 °C / 98.6 °F
- easy fixation of teeth

Melting point	Dimensions (L x W)	Thickness	Color	REF	Quantity
60 °C / 140 °F	175 x 80 mm	1.5 mm	pink	119-150-00	500 g

CE



Thermo wax

- heat-resistant wax for blocking-out
- for covering springs used in the Orthocryl® technique
- prevents acrylic from becoming milky in appearance

Melting point	Color	REF	Quantity
87 °C / 188.6 °F	pink	120-170-00	50 g



Sticky wax

- good adhesive effect on all materials
- ideal for the fixation of retentive or support elements, repair and soldering work

Melting point	Color	REF	Quantity
71 °C / 159.8 °F	red	122-300-00	60 g

Saw

For orthodontics/prosthetics.
Small saw with replaceable blades.

Contents:

Saw incl. 3 saw blades

REF 180-702-00

1 piece

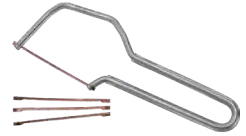

Saw blade

For saw.

Length	REF	Quantity
70 mm	180-703-00	5 pieces



FKO-split-post fixator

acc. to Gordon

This split-post fixator is designed for precise model positioning and holding. Special conical arms allow for the removal and replacement of models.

REF 072-004-00

1 piece



Polyclav®

Pressure vessel for polymerizing cold-curing resins such as Orthocryl®.
With safety valve.

Pressure hose not included.

Capacity: 4 l

REF 070-000-00

1 piece



Pressure hose

For Polyclav® (REF 070-000-00).

Length: 2 m

With plug nipple to fit inlet valve and standard connection for compressed air sockets.

REF 070-700-00

1 piece



Accessories



Heating plate

For Polyclav® (REF 070-000-00).

Power voltage	REF	Quantity
230 V~	070-900-00	1 piece
115 V~	070-901-00	1 piece

Technical data

Output	125 W
Thermostat for water temperature	43 °C / 109.4 °F
Power frequency	50/60 Hz
Weight	2.6 kg
Dimensions (W x H x D)	240 x 240 x 75 mm



Suction apparatus with charcoal filter

For protection against vapor during processing of acrylics in the laboratory.

- controlled by a photoelectric sensor (automatic switch on/off)
- includes hour meter
- easy-change filter (replace the filter cartridge, REF 072-001-30, after approx. 50 operating hours)

Power voltage	REF	Quantity
230 V~	072-001-00	1 piece
115 V~	072-002-00	1 piece

Technical data

Output	100 W
Power frequency	50 Hz
Weight	6 kg
Dimensions (W x H x D)	220 x 260 x 260 mm



Dermatril® disposable rubber gloves

For protection during work with polymethyl methacrylates such as Orthocryl®.

Made from special nitrile, free from powder and natural latex.

Layer thickness	Size	REF	Quantity
0.10 mm	S	162-907-00	100 pieces
0.10 mm	M	162-908-00	100 pieces
0.10 mm	L	162-909-00	100 pieces

CE 0121



DubliGel

Specialized duplicating material for secondary model in plaster.

- very clean duplication with all model plasters

Area of application:

- dental stone duplication

Color: pink

REF 165-501-00	5 kg
-----------------------	------

ecosil +

Additional cross-linked two component silicone.

- good color contrast
 - green color prevents mixing errors
- extremely thin flowing consistency
 - highly accurate duplicate reproduction
- long working time
 - can be used to re-cast models many times
- medium Shore hardness A (19)
 - use also with ring-free duplicating systems



Component	Color	REF	Quantity	REF	Quantity
A (catalyst)	yellow	108-703-10	1 kg	108-705-10	5 kg
B	blue	108-704-10	1 kg	108-706-10	5 kg

Technical data	A (catalyst)	B
Mixing ratio	1 : 1	
Viscosity	2000 mPas	
Density	1160 g/l	
Working time	6–8 min	
Setting time	30 min	
Shore hardness A	18–20	
Elastic memory	99.9 %	

Tap

For 5 kg canister.

REF 108-716-00	1 piece
----------------	---------



Orthodontic acrylics

Appliance containers and accessories



Appliance container, mini

The mini version is especially suitable for single appliances and oral screens (e.g. the Ulmer model).

Material: Plastic (dimensionally stable and impact resistant)

Dimensions (W x H x D): 7.00 x 3.30 x 4.80 cm

Size	Color	REF	Quantity
mini	pearl blue	163-602-01	10 pieces
mini	pink	163-603-01	10 pieces
mini	yellow	163-604-01	10 pieces
mini	orange	163-605-01	10 pieces
mini	green	163-606-01	10 pieces
mini	purple	163-609-01	10 pieces



Appliance container, maxi

The maxi version is especially suitable for bimaxillary appliances (e.g. activator, bionator).

Material: Plastic (dimensionally stable and impact resistant)

Dimensions (W x H x D): 7.80 x 4.50 x 5.60 cm

Size	Color	REF	Quantity
maxi	pearl blue	163-702-01	10 pieces
maxi	pink	163-703-01	10 pieces
maxi	yellow	163-704-01	10 pieces
maxi	orange	163-705-01	10 pieces
maxi	green	163-706-01	10 pieces
maxi	black	163-707-01	10 pieces
maxi	white flecked	163-708-01	10 pieces
maxi	purple	163-709-01	10 pieces



Appliance container, magnum

The magnum version is especially suitable for extremely large appliances

(e.g. Fraenkel appliances, orthodontic appliances for adult treatment, or dentures).

Material: Plastic (dimensionally stable and impact resistant)

Dimensions (W x H x D): 6.80 x 4.70 x 7.80 cm

Size	Color	REF	Quantity
magnum	pearl blue	163-802-01	10 pieces
magnum	pink	163-803-01	10 pieces

Appliance container, "football"

Universal size for removable upper appliances, bimaxillary appliances and function regulators incl. snap hook.

Material: Plastic (dimensionally stable and impact resistant)

Color	REF	Quantity
black-white	163-805-01	10 pieces



Snap hook

For attaching the appliance container to a belt loop.

REF 163-801-00	10 pieces
----------------	-----------



Cord with safety lock

For appliance containers, printed with "Dentaurum".

Color	REF	Quantity
a variety of colors	163-807-00	25 pieces



Premium-Line pliers	Page	354
Pliers and instruments	Page	358
Accessories	Page	360



Pliers and instruments.

Premium quality – premium function.



DENTAURUM
**ONLINE
SHOP**
shop.dentaurum.com



One program to cover all areas.

Whether for removable orthodontics or for prosthetics, the Dentaaurum pliers program includes instruments to serve all standard requirements. The user can always trust in consistent quality and reliability. This ensures quicker, more effective use.

Made in Germany.

Highly-experienced craftsmanship and state-of-the-art machinery have been used to produce these high-quality pliers which remain true to the tagline "Made in Germany". For this reason, Dentaaurum's Premium-Line pliers are extra long-lasting*.

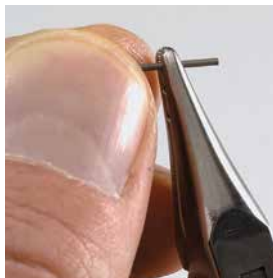



PREMIUM
LINE
10 year guarantee!**



*For instructions on how to clean and take care of the Dentaaurum pliers and instruments, please refer to our separate information sheet REF 989-590-20.

**The 10 year guarantee is on material and workmanship, loosening of cutting inserts, breakage and corrosion of pliers' body, providing the instruments have been used correctly and properly maintained. The guarantee does not apply if the equipment has been manipulated in any way.

Premium-Line pliers



Nance loop closing pliers sterilizable

For bending stop loops and as special pliers for Adams clasps.
Max. wire thickness: \varnothing 0.7 mm, hard
Premium-Line · 10 year guarantee

REF 001-002-00	1 piece
----------------	---------

CE



Angle wire bending pliers standard sterilizable

Sturdy constructed pliers with one cone and one pyramid shaped beak.
Max. wire thickness: \varnothing 0.7 mm, hard
Premium-Line · 10 year guarantee

REF 003-139-00	1 piece
----------------	---------

CE



Angle wire bending pliers sterilizable

Sturdy constructed pliers with one cone and one pyramid shaped beak. Inserts made of hard metal.
Max. wire thickness: \varnothing 0.7 mm, hard
Premium-Line · 10 year guarantee

REF 004-139-00	1 piece
----------------	---------

CE



Loop forming pliers Medium

For bending small springs, eyelets and loops.
Max. wire thickness: \varnothing 0.7 mm, hard
Premium-Line · 10 year guarantee

REF 003-053-00	1 piece
----------------	---------



Loop forming pliers Maxi

For bending springs, loops and space maintainers.
Max. wire thickness: \varnothing 0.8 mm, hard
Premium-Line · 10 year guarantee

REF 003-233-00	1 piece
----------------	---------



Ruhland loop forming pliers Magnum

For bending coffin springs and connecting springs, labial arches and U-loops.
Max. wire thickness: \varnothing 1.1 mm, hard
Premium-Line · 10 year guarantee

REF 001-650-00	1 piece
----------------	---------

Adams pliers Medium

With two smooth, rectangular beaks. Tungsten carbide coated working faces. Repair service available.

Length: 12.0 cm

Max. wire thickness: \varnothing 0.7 mm, hard

Premium-Line · 10 year guarantee

REF 003-515-00

1 piece



Adams pliers Medium

With two smooth, rectangular beaks.

Inserts made of hard metal. With guiding groove.

Length: 12.0 cm

Max. wire thickness: \varnothing 0.7 mm, spring hard

Premium-Line · 10 year guarantee

REF 004-515-00

1 piece



Adams pliers Maxi

With two smooth, rectangular beaks.

Length: 14.5 cm

Max. wire thickness: \varnothing 0.8 mm, hard

Premium-Line · 10 year guarantee

REF 003-094-00

1 piece



Adams pliers Medium

With one smooth, rectangular and one smooth, rounded beak.

Length: 14.0 cm

Max. wire thickness: \varnothing 0.7 mm, hard

Premium-Line · 10 year guarantee

REF 003-516-00

1 piece



Adams pliers Maxi

With one smooth, rectangular and one smooth, rounded beak. Inserts made of hard metal.

Length: 16.0 cm

Max. wire thickness: \varnothing 0.8 mm, hard

Premium-Line · 10 year guarantee

REF 004-095-00

1 piece



Wire bending pliers, wide

Serrated tips. Suitable for activating finger springs.

With guiding groove.

Max. wire thickness: \varnothing 0.8 mm, hard

Premium-Line · 10 year guarantee

REF 033-452-00

1 piece



Premium-Line pliers



Wire bending pliers Maxi

Universal bending and cutting pliers.

Inserts made of hard metal.

Max. wire thickness: \varnothing 0.9 mm, hard

Cuts up to: \varnothing 0.7 mm, hard

Premium-Line · 10 year guarantee

REF 013-522-00

1 piece



Universal wire bending pliers

With serrated tips and guiding grooves. Tungsten carbide coated working faces. Repair service available.

Max. wire thickness: \varnothing 0.8 mm, hard

Premium-Line · 10 year guarantee

REF 003-290-00

1 piece



Pointed beak pliers

Smooth beaks with guiding groove.

Inserts made of hard metal.

Max. wire thickness: \varnothing 0.7 mm, spring hard

Premium-Line · 10 year guarantee

REF 004-455-00

1 piece



Pointed beak pliers

Serrated beaks with guiding groove. Fine pointed.

Max. wire thickness: \varnothing 0.7 mm, hard

Premium-Line · 10 year guarantee

REF 035-455-00

1 piece



Young loop bending pliers

Universal pliers for different size loops.

Ideal for labial arches.

Max. wire thickness: \varnothing 0.7 mm, hard

Premium-Line · 10 year guarantee

REF 012-074-00

1 piece



Aderer 3-Prong pliers Mini

Length: 12.5 cm

Max. wire thickness: \varnothing 0.7 mm, hard

Premium-Line · 10 year guarantee

REF 003-201-00

1 piece

Premium-Line pliers

Aderer 3-Prong pliers Medium

Length: 13.0 cm

Max. wire thickness: \varnothing 0.9 mm, hard

Premium-Line · 10 year guarantee

REF 003-200-00

1 piece



Aderer 3-Prong pliers Maxi

Sturdy design.

Length: 15.5 cm

Max. wire thickness: \varnothing 1.5 mm, hard

Premium-Line · 10 year guarantee

REF 003-202-00

1 piece



Arrow clasp former

Max. wire thickness: \varnothing 0.7 mm, hard

Premium-Line · 10 year guarantee



REF 012-520-00

1 piece



Arrow clasp bending pliers

Max. wire thickness: \varnothing 0.7 mm, hard

Premium-Line · 10 year guarantee



REF 012-521-00

1 piece



Facebow bending pliers Magnum

sterilizable

Ideal for bending the outer bows of a facebow.

Max. wire thickness: \varnothing 1.8 mm

Premium-Line · 10 year guarantee

REF 003-180-01

1 piece

CE



Pliers and instruments



Adams clasp bending pliers

Special pliers for easy forming of Adams clasps.
Max. wire thickness: \varnothing 0.7 mm, hard

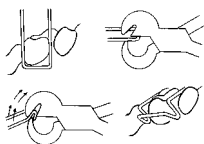

REF 012-523-00

1 piece



Heavy gauge side cutter Magnum

Little force required for cutting through large size wires due to special design.
We do not recommend using the front third of the cutters for cutting wires with the maximum indicated thickness!
Max. wire thickness: \varnothing 1.3 mm, hard

REF 044-177-00

1 piece



Scissors

For cutting thin metal bands.

Version	REF	Quantity
straight	007-024-00	1 piece
curved	008-025-00	1 piece



Mosquito forceps without hook sterilizable

Crown forceps or for placing Dentalastics® plastic ligatures.

REF 000-730-00

1 piece

CE



Crown Master forceps

Firm grip of crowns. Heat-resistant up to 200 °C / 392 °F.

REF 260-300-02

1 piece

Casting ring tongs

- for large and small casting rings
- stainless

Length: 56.0 cm

REF 127-400-00

1 piece



Model and casting ring tongs

- angled jaws give more secure grip for refractory models and casting rings (Sizes 1/3/6)

- stainless

Length: 36.0 cm

REF 127-410-00

1 piece



Accessories



Maintenance and protection oil for pliers and instruments

For the maintenance of pliers and instruments.
Application in particular before sterilisation.

REF 055-201-00

50 ml

CE



Stand for wires and pliers

Material: plastic

With 6 tubes for straight wires.

Do not use disinfectants containing ethanol, phenol or alcohol.

Color: transparent, clear

Height: approx. 13 cm

Width: approx. 18 cm

REF 055-101-01

1 piece



Stand for pliers

Do not use disinfectants containing ethanol, phenol or alcohol.

suitable for	Material	Color	Length	REF	Quantity
approx. 7 pliers	plastic	transparent, clear	13.0 cm	055-000-00	1 piece
approx. 14 pliers	plastic	transparent, clear	25.5 cm	055-100-00	1 piece



Welding units and accessories	Page	368
Casting unit and accessories	Page	380
Surveying equipment and accessories	Page	384
Electric wax knife	Page	387
Model trimmer and accessories	Page	389
Pressure vessel and suction unit	Page	390
Blasting abrasive	Page	391
Miscellaneous	Page	392



Equipment.

For professional workmanship.



DENTAURUM
**ONLINE
SHOP**
shop.dentaurum.com





Certified quality made in Germany.

Dentaurum equipment meets the highest demands on laboratory safety and robustness. Not only is functionality of great importance, but also user comfort.

Maintenance-friendly machine construction.

Specially trained mechanics help sustain a professional machine management service. Maintenance contracts and a long-term guarantee of spare parts aid in preserving the machines, even when constantly in laboratory use.

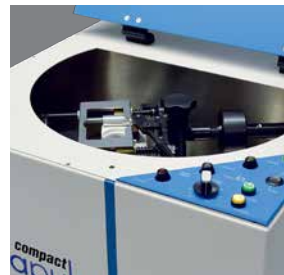

desktop Compact

Universal laser welding unit.

Spot welding units

Junior 3000, Assistent 3000 and Master 3000.

megapuls compact

Compact, high frequency casting unit.

Paratherm, Paraline

Surveying and blocking-out devices.

Thermomat

Electrical wax knife with various attachments.

Dual-wheel model trimmer

Beautiful models – trimmed quickly and neatly.

Dentaurum laser technology.

Professional welding in prosthetics.

Laser welding – the modern joining technique.

Laser welding allows more efficient processing. In comparison with traditional soldering, you can save up to 80 % of your time. You can carry out new fabrications and repair jobs better and faster by using a dental laser.

Highest degree of biocompatibility.

Due to their high susceptibility to corrosion, biocompatibility in solder joints is rated rather low. Consequently, metallurgists and toxicologists have recently taken a very critical stance towards the traditional soldering method. This problem is further aggravated by increasing occurrences of allergic reactions. By using the laser welding technique, you can avoid this issue.

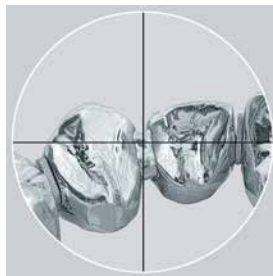

Maximum stability.

Laser-welded connections present a significantly higher mechanical resistance and are more durable than soldered connections. This means more security and higher quality for the dentist and patients.

Broad spectrum of application.

With laser welding entering into the field of dental joining techniques the spectrum of application has been considerably improved and expanded. The desktop Compact is also well suited for metal joints in orthodontics.

Whether you want to process precious metal alloys with a high gold content, non-precious alloys or titanium, you cover the whole range of dental materials using laser welding.

The ergonomics – extremely user-friendly.

A special characteristic feature of the Dentaaurum laser is its special ergonomic design. Working becomes a relaxed and easy affair for you.

- The excellent ergonomics of the Dentaaurum laser are reflected in the optimal inclination of the laser axis. Thereby not only do you sit relaxed in front of the microscope, but you can also hold the workpiece at an optimal angle.
- The laser optics excels in exceptional in-depth sharpness. That means: the welding performance does not change, even if you do not adhere to the optimal welding plane.
- Due to the argon nozzle, the workpiece is always flushed with argon. This ensures an oxidation-free welding fusion with high stability.

Welding units and accessories



desktop Compact

Laser welding – powerful and easy to use.

More than 20 years of dental laser welding technique accumulated in a compact table unit. From delicate, detailed welding to secure joints, the desktop Compact laser can be used for all areas of application in dental prosthetics and orthodontics. The finely adjustable dosage makes welding so much easier. Until now, such compact machine measurements were not available in this laser performance category. Simple machine operation prevents fatigue during work.

Advantages:

- extremely compact table top unit
- clear and user-friendly touchscreen
- high output reserve
- ergonomically designed – large working chamber with inclining laser axis
- high-quality microscope with a wide field of vision
- integrated pulse forming – 4 pre-set pulse shapes
- two inert gas nozzles, 1 x flexible and 1 x fixed retractable
- large pulse adjustment range – easy operation using joysticks
- integrated extraction and cool air nozzle

Further product information is available on request.

Power voltage	REF	Quantity
230 V~	090-578-50	1 piece

Technical data

max. power	50 W
Peak pulse output	5000 W
Pulse energy	50 J
Pulse duration	0.5–20 ms
Pulse frequency	single pulse – 25 Hz
Welding spot diameter	0.2–2.0 mm, infinitely variable motorized adjustment
Memory settings	39
Pulse shaping	4 pre-set pulse shapes
Argon nozzle	1 x flexible, 1 x fixed retractable
Air nozzle	integrated in welding chamber
Extraction	integrated with suspended particle filter
Microscope	stereo microscope with 16x magnification
Lighting	2 x 20 W Halogen
max. working height	180 mm
Electric fuse	T 16 A
Power frequency	50/60 Hz
Weight	50 kg
Dimensions (W x H x D)	510 x 430 x 645 mm

Welding units and accessories

Electrically adjustable stand

The answer to unsurpassed ergonomics with the Dentaurum desktop laser-welding units.

Advantages:

- this stand offers the user the best possible ergonomics
- the electrically adjustable stand enables the technician to change to his or her comfort level, via a foot switch, within seconds. This offers the most comfortable viewing level, and assures full concentration on the laser work
- the stand is designed to guarantee fatigue-free laser welding, even after extended periods of time
- can be used with all Dentaurum desktop laser-welding units



Power voltage	REF	Quantity
230 V~	090-574-00	1 piece

Technical data

Power frequency	50 Hz
min. working height	740 mm
max. working height	1090 mm

CoCr welding wire

Various dimensions to be used as a filling soldering wire for all CoCr alloys.

ø	Length	REF	Quantity
0.25 mm / 10	2 m	528-215-10	1 piece
0.35 mm / 14	2 m	528-210-10	1 piece
0.50 mm / 20	2 m	528-200-10	1 piece



CE 0483

Composition (percentage by mass)

Co	Cr	Mo
65.0	28.0	5.5

Additional elements < 1 %: Mn, Si



DENTAURUM
ONLINE SHOP
shop.dentaurum.com



Welding units and accessories



NiCr welding wire

For laser welding NiCr based alloys. Specifically for high grade alloys such as remanium® CS+, CSe and G-soft.

ø	Length	REF	Quantity
0.50 mm / 20	2 m	528-220-00	1 piece

CE⁰⁴⁸³

Composition (percentage by mass)

Ni	Cr	Mo	Nb
63.0	22.0	9.0	3.5

Additional elements < 1 %: Al, Co, Fe, Ti

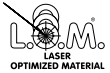

rematitan® wire on coils

Titanium grade 1

Norm: DIN 17850

For laser welding.

Recommended as filler material for laser welding, e.g. with titanium RPE appliances (Titan hyrax® Maxi – 12).

ø	Length	REF	Quantity
0.40 mm / 16	2 m	528-039-50	1 piece
0.70 mm / 28	2 m	528-040-50	1 piece

CE⁰⁴⁸³



rematitan® straight wire

Titanium grade 1

Norm: DIN 17850

For laser welding.

Recommended as reinforcing wire for fixed titanium RPE appliances (Titan hyrax® Maxi – 12).

ø	Length	REF	Quantity
1.00 mm / 39	each 100 mm	528-041-00	10 pieces
1.20 mm / 47	each 100 mm	528-042-00	10 pieces

CE⁰⁴⁸³

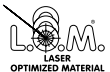

rematitan® straight wire

Titanium grade 4

Norm: DIN 17850

For laser welding.

Recommended for axes of swing locks.

ø	Length	REF	Quantity
1.50 mm / 59	50 mm	528-050-00	1 piece

CE 0483



rematitan® straight wire

Titanium grade 1

Norm: DIN 17850

For laser welding.

ø rolled	Length	REF	Quantity
0.25 x 3.0 mm / 10 x 118	each 100 mm	528-044-00	10 pieces
0.5 x 1.5 mm / 20 x 59	each 100 mm	528-043-00	10 pieces

CE 0483



Titanium disc holder for laser welder

This holder is a device for adjusting the crosshair and efficiency check of dental laser welders. The titanium disc is clamped into the adjustable holder. The height is then perfectly adjusted inside the welding chamber. As soon as the titanium disc is visible in the microscope, the laser beam is aimed at the titanium disc and the crosshair can be aligned with that particular point.

REF 090-525-00

1 piece



Titanium disc

To be used with the titanium disc holder for the laser welder (REF 090-525-00).

REF 090-526-00

5 pieces



Equipment

Welding units and accessories



Paralas

Device for parallel alignment of attachments for the laser welding technique.

Incl. 2 paralleling holders for bars:

1.6 mm (REF 210-023-00) and 2.1 mm (REF 210-013-00)

REF 090-520-00

1 piece



Parallel holder for bar

Available in 2 designs for bar hinges and bar attachments.

Version	Width	REF	Quantity
micro	1.6 mm	210-023-00	1 piece
macro	2.1 mm	210-013-00	1 piece



Argon fitting

For laser.

For connecting the laser to the argon bottle.

- flow rate shown in liters

REF 090-404-00

1 assortment



Armrest cushion

For laser.

REF 090-513-10

2 pieces



Special tungsten electrodes

For OrthoPhaser®.

- special electrodes for all applications

ø: 0.6 mm

REF 090-401-00

10 pieces

Spot welding unit Junior 3000

- no continuous soldering
- toggle switch for operating mode
- connection for hand electrode
- connection for foot switch

Hand electrodes, holder for hand electrodes and foot switch are not included!



Power voltage	REF	Quantity
230 V~	077-000-00	1 piece

Technical data

Output	115 W
Welding power	up to 1200 A
Welding stages	2 stages
Soldering stages	1 stage
Electric fuse	T 2 A
Power frequency	50/60 Hz
Weight	7 kg
Dimensions (W x H x D)	335 x 130 x 310 mm

Welding units and accessories



Spot welding unit Assistent 3000

- button for continuous soldering
- LED display
- automatic voltage detection
- current limitation if electrode is incorrect
- power saving device (stand-by mode if not used for 10 minutes)
- error indications for:
 - overheating
 - mix-up of electrodes
- connection for hand electrode
- connection for foot switch

Hand electrodes, holder for hand electrodes and foot switch are not included!

Power voltage	REF	Quantity
110–240 V~	078-000-00	1 piece

Technical data

Output	140 W
Welding power	up to 2000 A
Welding stages	6 stages
Soldering stages	2 stages, continuous soldering
Electric fuse	T 3: 15 A
Power frequency	50–60 Hz
Weight	8 kg
Dimensions (W x H x D)	335 x 130 x 310 mm

Spot welding unit Master 3000

- infinite power adjustment in all modes
- button for continuous soldering
- LCD-display with 5 language settings (German, English, French, Italian, Spanish) for selection by the customer
- automatic voltage detection (110–240 V~)
- current limitation if electrode is incorrect
- power saving device (stand-by mode if not used for 10 minutes)
- error indications for:
 - overheating
 - mix-up of electrodes
 - system problems
- printer connection e.g. for welding report as patient documentation, (REF 090-581-00)
- connection for hand electrode
- connection for foot switch

Hand electrodes, holder for hand electrodes and foot switch are not included!



Power voltage	REF	Quantity
110–240 V~	079-000-00	1 piece

Technical data

Output	140 W
Welding power	up to 2200 A
Welding stages	stageless
Soldering stages	stageless, continuous soldering
Electric fuse	T 3: 15 A
Power frequency	50–60 Hz
Weight	8.2 kg
Dimensions (W x H x D)	335 x 130 x 310 mm



Welding units and accessories



Foot switch

To be used with the spot welding units Junior 3000, Assistant 3000 and Master 3000.

REF 080-116-00	1 piece
----------------	---------



Hand electrode

Suitable for all Dentaaurum spot welding units.

REF 081-101-00	1 piece
----------------	---------



Holder for hand electrode

For the spot welding units Junior 3000, Assistant 3000 and Master 3000.

Version	REF	Quantity
for right and left side	081-204-00	2 pieces
for right side	081-205-00	1 piece
for left side	081-206-00	1 piece



Soldering carbon for hand electrode

Suitable for all Dentaaurum spot welding units.

- copper casing

REF 081-601-00	1 piece
----------------	---------



Electrode, notched, for hand electrode

Suitable for all Dentaaurum spot welding units.

- for soft-annealing, tempering and welding

REF 081-501-00	2 pieces
----------------	----------



Clamping electrode for hand electrode

Suitable for all Dentaaurum spot welding units.

- for soft-annealing, tempering and welding

REF 081-701-00	1 piece
----------------	---------

Welding electrode

Suitable for all Dentaaurum spot welding units.

Material: copper

Welding electrode	Version	REF	Quantity
upper	round, fine	085-000-00	1 piece
upper	wide, flat	085-100-00	1 piece
upper	round, thick	085-200-00	1 piece
lower	round, fine	086-000-00	1 piece
lower	wide, notched	086-100-00	1 piece
lower	round, thick	086-200-00	1 piece
lower	wide, flat	086-300-00	1 piece



Soldering electrode

Suitable for all Dentaaurum spot welding units.

- carbon with holder

REF 085-300-00

1 piece



Carbon insert

For soldering electrode (REF 085-300-00).

REF 085-400-00

10 pieces



Equipment

Welding units and accessories



Screw

- for tightening electrodes on Dentaaurum spot welding units

REF 084-100-00

10 pieces



Fuse

Characteristic	Power	REF	Quantity
slow	2.00 A	907-047-10	1 piece
slow	3.15 A	907-037-10	1 piece



Screwdriver

- for replacing electrodes on all Dentaaurum spot welding units

REF 083-100-00

1 piece



File

- for cleaning copper and carbon electrodes on spot welding units

REF 083-300-00

10 pieces



Heat protection

Protects metal, plastic and ceramic parts against heat damage during soldering.

REF 380-070-00

100 g



Dentaflux® flux

- universal flux
- for all alloys
- especially for connections between precious and non-precious alloys

REF 681-100-00

50 g

Universal silver solder

- in rods
- ready fluxed
- cadmium free

Not permitted for intra-oral use.

∅	1–1.1 mm
Working temperature	700 °C / 1292 °F

REF 380-604-50	1.2 g
REF 380-604-60	10 x 1.2 g

Composition (percentage by mass)

Ag	Zn	Cu
59.0	24.0	16.0

with flux



Universal silver solder

- in coils
- without flux
- cadmium free

Not permitted for intra-oral use.

Working temperature	700 °C / 1292 °F
---------------------	------------------

REF 380-704-50	10 g
----------------	------

Composition (percentage by mass)

Ag	Zn	Cu
59.0	25.0	16.0

without flux



White gold solder

- in rods
- ready fluxed
- purity: ct 18.6
- cadmium free

Not permitted for intra-oral use.

∅	1–1.1 mm
Working temperature	950 °C / 1742 °F

REF 380-600-50	1.6 g
----------------	-------

Composition (percentage by mass)

Au	Ni	Zn
77.0	16.0	6.0

with flux



Casting unit and accessories



megapuls compact

The megapuls compact is a compact, high frequency, centrifugal casting unit. Can be used for all types of casting requirements within the dental laboratory from non-precious metal alloys to precious metal alloys (except titanium). Easy operation and high centrifugal strength aid in producing perfect casting results including detailed technical work.

Advantages:

- exceptionally compact, high frequency casting machine
- very short melting cycles due to strong performance, the casting arm quickly comes to a halt
- capable of casting 25 x in succession
- short melting times: e.g. CoCr model casting approx. 40 s
- easy operation
- high centrifugal strength
- casting performance can be adjusted gradually
- HF coil is lowered automatically

Further product information is available on request.

Power voltage	REF	Quantity
230 V~	090-620-00	1 piece

Technical data

Max. temperature	1750 °C / 3182 °F
Torque	0...21 Nm
max. Melting quantity	100 g precious metal, 70 g CoCr
Water requirement	2 l/min
Power frequency	50–60 Hz
Weight	55 kg
Dimensions (W x H x D)	560 x 400 x 580 mm

Casting unit and accessories

Crucible for megapuls compact

- long life time
 - minimum adherence of metal and slag
- Field of use:** CoCr, NiCr, Pd alloys
Material: ceramics

REF 090-611-00

10 pieces



Graphite insert

For ceramic crucible REF 090-610-00 and REF 090-611-00.
Field of use: precious metal alloys

REF 090-615-00

10 pieces



Crucible

For megapuls casting machines up to year of construction 2005.
Field of use: CoCr, NiCr, Pd alloys
Material: ceramics

REF 090-610-00

10 pieces



Casting unit and accessories



Table with integrated water tank and pump

The circulating cooling water allows to operate the casting machine megapuls compact without an exterior water supply. At the same time the height of the table guarantees optimal working conditions.

Power voltage	REF	Quantity
230 V~	090-606-00	1 piece

Technical data

Output	260 W
Filling quantity	20 l
Pump capacity	9 l/min
Electric fuse	T 1.6 A
Power frequency	50/60 Hz
Weight	41.5 kg
Dimensions (W x H x D)	680 x 650 x 600 mm

Casting unit and accessories

Ceramic seal

For rematitan®, rematitan® autocast and autocast universal® 230 casting machines.

- asbestos free
- high temperature resistant casting ring seal

REF 090-012-60

100 pieces

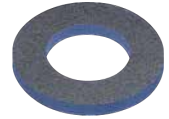

Crucible for titanium casting machines

For rematitan®, rematitan® autocast and autocast universal® 230 casting machines.

Material: copper

REF 090-110-00

1 piece



Receptacle for ceramic crucible

For autocast universal® casting machine.

REF 090-160-00

1 piece



Ceramic crucible

For autocast universal® casting machine.

Version	REF	Quantity
standard	090-161-00	10 pieces
large	090-161-50	10 pieces



Crucible electrode

For autocast universal® casting machines.

REF 090-162-00

5 pieces



Surveying equipment and accessories



Paratherm Surveying, blocking-out and waxing unit

Advantages:

- flexible measuring movement with linearly guided sliding bars
- horizontal swiveling range of the two arms over the entire working area
- separate measuring and thermal blocking-out rods, vertically spring adjustable. All positions can be fixed in place
- secure lockings
- thermal temperature can be regulated up to 140 °C / 284 °F
- replaceable tips
- heavy, rigid construction
- instrument storage holder
- connection for electric wax knife and holder (Potentiometer and socket)

Contents of delivery:

- 1 Paratherm with surveying and blocking-out arm
- 1 analyzing rod (REF 094-287-00)
- 1 graphite holder (REF 094-288-00)
- 10 replacement graphite markers (Graphite, REF 094-289-00)
- 4 undercut gauges 0.25 mm (REF 094-283-00), 0.35 mm (REF 094-284-00), 0.5 mm (REF 094-285-00), 0.75 mm (REF 094-286-00)
- 2 thermal blocking-out instruments 0° (REF 094-275-00), 2° (REF 094-277-00)
- 1 plastic cover
- 1 fuse

Please order model table (REF 086-340-00) and wax knife (REF 094-272-00) separately.

Power voltage	REF	Quantity
110/230/240 V~	094-270-00	1 piece

Technical data

Output	22 W
Power frequency	50/60 Hz
Weight	4.7 kg
Dimensions (W x H x D)	200 x 390 x 240 mm



Paraline

Surveyor (no blocking-out unit). Based on the Paratherm unit. No connection socket available for electric wax knife.

Contents of delivery:

- 1 Paraline unit
- 1 analyzing rod (REF 094-287-00)
- 1 graphite holder (REF 094-288-00)
- 10 replacement graphite markers (Graphite, REF 094-289-00)
- 4 undercut gauges 0.25 mm (REF 094-283-00), 0.35 mm (REF 094-284-00), 0.5 mm (REF 094-285-00), 0.75 mm (REF 094-286-00)
- 1 plastic cover

Please order model table (REF 086-340-00) separately.

Technical data

Dimensions (W x H x D)	200 x 390 x 240 mm
------------------------	--------------------

REF 094-290-00	1 piece
-----------------------	---------

Surveying equipment and accessories

Analyzing rod

For Paratherm and Paraline.

REF 094-287-00

1 piece



Graphite holder

For Paratherm and Paraline.

REF 094-288-00

1 piece



Replacement graphite markers

For Paratherm and Paraline.

REF 094-289-00

10 pieces



Undercut gauge

For Paratherm and Paraline.

Undercut	REF	Quantity
0.25 mm	094-283-00	1 piece
0.35 mm	094-284-00	1 piece
0.50 mm	094-285-00	1 piece
0.75 mm	094-286-00	1 piece



Thermal blocking-out tip

For Paratherm.

Degrees	REF	Quantity
0°	094-275-00	1 piece
1°	094-276-00	1 piece
2°	094-277-00	1 piece
3°	094-278-00	1 piece
4°	094-279-00	1 piece
6°	094-280-00	1 piece
8°	094-281-00	1 piece



Surveying equipment and accessories



Electric wax knife

For connection to the Paratherm unit. The models to be blocked-out can be waxed directly on the unit. Anatomically shaped wax knife.

Contents of delivery:

- handpiece
- cable
- wax knife (REF 089-602-00)

Temperature setting: stageless up to 280 °C / 536 °F

REF 094-272-00

1 piece



Model table

- fully adjustable model holder
- zero position return
- easy and secure mounting of models
- large base
- cast aluminum
- clean and sturdy construction

REF 086-340-00

1 piece

Electric wax knife

Thermomat

Electric wax knife with transformer.

Included:

- handpiece with 1 wax knife (REF 089-602-00)
- 1 holder for wax knife (REF 089-615-00)



Power voltage	REF	Quantity
230 V~	089-620-00	1 piece

Technical data

Max. temperature	280 °C / 536 °F, adjustable
Cable length	95 cm
Power frequency	50 Hz

Holder for wax knife

Material: silicone

REF 089-615-00	1 piece
----------------	---------



Electric wax knife

Modeling tip for the Thermomat



Designation	REF	Quantity
Wax knife, small	089-602-00	1 piece
Wax knife, large	089-605-00	1 piece
Modeling tip, fine	089-603-00	1 piece
Modeling tip, medium	089-604-00	1 piece
Modeling spoon	089-606-00	1 piece



Handpiece with cable

For Thermomat (REF 089-620-00).

REF 089-612-00

1 piece

Model trimmer and accessories

Dual wheel model trimmer

For plaster models.

Coarse and fine corundum grinding wheels. Can be used on either side. Separately controlled motor switches with 450 W capacity. Individually controlled water pressure by a magnetic water valve. Work area with squaring and angulation devices.



Power voltage	REF	Quantity
230 V~	091-100-00	1 piece

Technical data

Output	2 x 450 W
Turning rotations	1400 min ⁻¹
Power frequency	50/60 Hz
Weight	39 kg
Dimensions (W x H x D)	530 x 400 x 385 mm

Corundum disc

For Dentaaurum dual wheel model trimmer (REF 091-100-00).

Grain size	REF	Quantity
46 = coarse	091-101-00	1 piece
120 = fine	091-102-00	1 piece



Diamond disc

For Dentaaurum dual wheel model trimmer (REF 091-100-00).

- long operating life
- extremely high abrasive capacity
- minimal force required

REF 091-105-00	1 piece
----------------	---------



Pressure vessel and suction unit



Polyclav®

Pressure vessel for polymerizing cold-curing resins such as Orthocryl®.
With safety valve.

Pressure hose not included.

Capacity	REF	Quantity
4 l	070-000-00	1 piece



Heating plate

For Polyclav® (REF 070-000-00).

Power voltage	REF	Quantity
230 V~	070-900-00	1 piece
115 V~	070-901-00	1 piece

Technical data

Output	125 W
Thermostat for water temperature	43 °C / 109.4 °F
Power frequency	50/60 Hz
Weight	2.6 kg
Dimensions (W x H x D)	240 x 240 x 75 mm



Pressure hose

For Polyclav® (REF 070-000-00).

Length: 2 m

With plug nipple to fit inlet valve and standard connection
for compressed air sockets.

REF 070-700-00	1 piece
----------------	---------



Suction apparatus with charcoal filter

For protection against vapor during processing of acrylics in the laboratory.

- controlled by a photoelectric sensor (automatic switch on/off)
- includes hour meter
- easy-change filter (replace the filter cartridge, REF 072-001-30, after approx. 50 operating hours)

Power voltage	REF	Quantity
230 V~	072-001-00	1 piece
115 V~	072-002-00	1 piece

Technical data

Output	100 W
Power frequency	50 Hz
Weight	6 kg
Dimensions (W x H x D)	220 x 260 x 260 mm

Blasting abrasive

99.6 % aluminum oxide (corundum) Al_2O_3

- hard, angular, wear-resistant particles for intense, fast cleaning action
- for removing investment in sandblasters
- for surface conditioning with metal surfaces

Color: white

Grain size	Grain size	REF	Quantity
50	44–74 μm	128-017-00	4.5 kg
100	88–125 μm	128-020-00	4.5 kg
250	210–297 μm	128-016-00	10 kg
400	354–500 μm	128-015-00	10 kg

Dentaurem corundum satisfies the blasting medium requirements of the profession and national health and safety regulations.



Blasting abrasive

corundum

- for removing investment in sandblasters

Color: brown

Grain size	Grain size	REF	Quantity
250	210–297 μm	128-011-00	10 kg
500	420–595 μm	128-010-00	10 kg



Polishing beads

hardened silicate

- uniform hardness, high durability
- for clean, polished, contamination-free surfaces
- no metal removal
- ultra-effective cleaning action

Grain size	Grain size	REF	Quantity
75	50–105 μm	128-211-00	4.5 kg



Miscellaneous



Mini-Torch

Ignition and flame adjustment is easy and uncomplicated (automatic, with a flick of your finger). Refill as easy as filling a lighter. Adjustable nozzle.

GS certified.

Technical data

Max. temperature	1300 °C / 2372 °F
Filling quantity	65 ml
Weight	280 g

REF 097-400-01

1 piece



Mixing bowl for Airvac 2002

Stirring unit	Filling capacity investment material	Filling capacity plaster	REF	Quantity
large	900 g	700 g	095-062-00	1 piece
medium	500 g	400 g	095-063-00	1 piece
small	120 g	100 g	095-064-00	1 piece



Dust filter for Dentablast and Dentablast Duo

Field of use: when no suction is present

REF 094-538-00

1 piece

remanium® kompendium	Page 396
o-atlas II	Page 398
Online media library	Page 400
Download center	Page 402
Social media	Page 404



Knowledge.

The key to success.



DENTAURUM
**ONLINE
SHOP**
shop.dentaurum.com



remanium® kompendium.

Compiled by dental technicians for dental technicians.

www.remanium-kompendium.de/eng

Both the apprentice and experienced dental technician will find a wealth of valuable information on important aspects for the fabrication of non-precious metal restorations in the three-part remanium® kompendium series. The individual chapters of the remanium® kompendium complement one another but are nevertheless self-contained. Practical working stages are photo-documented with the focus always on the pictorial language. A brief description with highlighted advice and tips make it a very appealing and useful reference book.

Chapter 1: Crowns and bridges

out of print

Chapter 2: Cast partial dentures

out of print

Chapter 3: Milling technique made of
remanium® alloys

REF 989-474-20

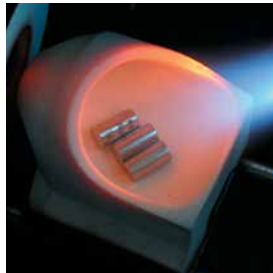



Chapter 1: Crowns and bridges.

The first part of the remanium® kompendium describes the fabrication of crowns and bridges with particular reference to the different processing techniques in comparison to precious metal alloys. The numerous photographs illustrate the individual working stages for the reader including fabrication of a bridge framework, build-up of the ceramic and polishing of a full metal crown.



Chapter 2: Cast partial dentures.

The second part of the kompendium series describes the procedure during fabrication of a clasped partial denture. Starting with model analysis and the principles of statics, the entire procedure is presented in detail up to polishing of the cast partial denture framework. The concept is completed with a description of different types of clasps and examples of cases.



Chapter 3: Milling-technique made of remanium® alloys.

The third part includes the most important areas of prosthetic applications which can be used for fabricating removable restorations. All techniques are clearly illustrated including the telescope technique and other types of attachment, bar or lock restorations.





New edition: o-atlas II

The reference guide for removable orthodontic appliances.

Atlas of removable orthodontic appliances.

In a fully revised, extended edition with new images, Ursula Wirtz presents all of the important removable orthodontic appliances.

It is a standard reference work designed as a work and study aid for removable orthodontic appliances and is widely illustrated. It serves as a comprehensive reference guide for both orthodontists and dental technicians.

The o-atlas II gives clear, precise information on how to make an orthodontic appliance. The new edition is characterized by its pleasing, modern design.

- Approximately 390 pages with more than 1,000 illustrations, hardback version.
- 235 different orthodontic appliances are shown and described. The o-atlas II includes 44 new orthodontic appliances.
- More than 800 images have been replaced with new images of high quality.
- A 360 degree product view of the 50 most interesting orthodontic appliances is available online at www.o-atlas.com.
- Intelligent connection between print and online media in the o-atlas II.

Order now – ordering information:

Book – German	REF 903-920-10
Book – English*	REF 903-920-20
Book – French*	REF 903-920-30
Book – Spanish*	REF 903-920-40



NEW



* Date of publication: March 2019

Online media library.

Video instructions on the internet.

www.dentaurum.com/eng/media-library

See how it works.

You can find video clips and animations in best quality explaining step-by-step how to use our products at www.dentaurum.com.

- More than 50 minutes of top quality films and animation on prosthetic and orthodontic dentistry.
- Video clips on processing Orthocryl®.
- Video clips on crowns, bridges and cast partial dentures.
- Presentation of new products.





Digital technologies



ceraMotion®



Crowns and bridges



Cast partial denture



Laser

Downloads.

For easy and convenient access to instructions for use and further documents.

www.dentaurum.com/eng/downloads

Downloads free of charge.

We want to make access to important documents on our products as easy as possible for you.

At www.dentaurum.com you will find a large selection of free downloads in our download center, organized for easy access. Its structure is easy to follow.

- Instructions for use.
- Safety data sheets.
- Product information.
- Catalogs.
- Specialist publications.
- Patient information.
- Courses.
- Certificates.





Social media.

Always up-to-date.



www.facebook.com/DentaurumGermany



www.youtube.com/Dentaurum



www.instagram.com/dentaurum_germany

You will find current information, offers and insights into our company on our Social Networks.
Connect with us!



www.pinterest.com/dentaurumgmbhco



www.xing.com/companies/dentaurumgmbh&co.kg



www.kununu.com/dentaurum-co

CDC – Centrum Dentale Communicatie	Page 408
Courses and Events	Page 410



Courses and Events.



Knowledge connects.



More than 20 years of high-quality education.



Long-standing expertise.

The CDC, established in 1996, stands for long-standing expertise in organizing and holding professional training sessions and events. In 2016, CDC celebrated its 20th anniversary and has long established itself as a modern, forward-looking training center. The idea of passing on knowledge and offering courses goes back to the year 1910. Back then, courses were held on metal and porcelain techniques. Today, CDC offers numerous courses.

Making further education an event.

The CDC – Centrum Dentale Kommunikation – in Ispringen is more than just a venue; modern furnishing, a relaxed environment and a great ambiance turn your course into an event.



Convincing quality.

On April 6, 1999, the CDC was the first training center to be successfully certified.

Renowned lecturers.

Our lecturers take time for you! Small groups and a highly motivated and competent team of lecturers guarantee that the course can be adapted to suit your requirements.

Courses and events from the Dentaforum Group – online – it can't get any faster!

The quickest source of information is of course the internet. All available courses are listed on the Dentaforum homepage and you can apply online. It's always worth taking a look at our homepage – apart from our standard courses you can also find information on special events and further courses on offer.

Overview.



www.dentaurum.com



Service and hotline numbers	Page	11
Conversion charts	Page	414
Environment	Page	416
Alphabetical index	Page	418
Numerical index	Page	426



Dentaurum service.

Added value – advice and support.



Conversion charts

Note:

- ∅ round
- ▭ rectangular

In addition to the metric measurements provided, the wires are also available with an additional description¹ in inches (DIN ISO 15841) e.g. 17 x 25 = .017" x .025"

1 mm	= 0.0394 inch
1 cm	= 10 mm = 0.3937 inch
1 m	= 1000 mm = 1.0936 yards
1 km	= 0.6214 miles
1 inch	= 25.40 mm
1 foot	= 12 inches = 30.48 cm
1 yard	= 3 feet = 91.44 cm
1 mile	= 1760 yards = 1.6093 km

1 mg	= 0.0154 grain
1 g	= 1000 mg = 0.0353 oz
1 kg	= 1000 g = 2.2046 lb
1 ounce	= 28.35 g
1 pound	= 16 ounces = 0.4536 kg

1 MPa	= 1 N/mm ²
1 N/mm ²	= 145.14 p. s. i.
1 p. s. i.	= 0.00689 N/mm ²

1 l	= 1000 ml = 2.11 pints
	= 1.06 quarts = 0.26 gallons

FDI System		18	17	16	15	14	13	12	11	21	22	23	24	25	26	27	28
R	8	7	6	5	4	3	2	1	1	2	3	4	5	6	7	8	L
	8	7	6	5	4	3	2	1	1	2	3	4	5	6	7	8	
	48	47	46	45	44	43	42	41	31	32	33	34	35	36	37	38	

mm ∅ descr. ¹		Wire 1 kg	mm ∅ descr. ¹		Wire 1 kg
0.10	4	16120 m*	0.60	24	448 m*
0.15	6	7150 m*	0.70	28	329 m*
0.20	8	4030 m*	0.80	32	251 m*
0.22	9	3335 m*	0.90	36	198 m*
0.25	10	2590 m*	1.00	40	161 m*
0.28	11	2055 m*	1.10	44	133 m*
0.30	12	1793 m*	1.20	48	112 m*
0.35	14	1315 m*	1.30	51	95 m*
0.40	16	1010 m*	1.40	55	82 m*
0.45	18	795 m*	1.50	59	71 m*
0.50	20	645 m*			

*We accept no responsibility for the accuracy of this information

inch	mm
1/64	0.0156
1/32	0.0312
1/16	0.0625
1/8	0.1250
3/16	0.1875
1/4	0.2500
5/16	0.3125
3/8	0.3750
1/2	0.5000
5/8	0.6250
3/4	0.7500
1	1.0000

°C	°F	°C	°F
-40	-40	110	230
-30	-22	120	248
-20	-4	130	266
-10	+14	140	284
0	+32	150	302
10	50	200	392
20	68	300	572
30	86	400	752
40	104	500	932
50	122	600	1112
60	140	700	1292
70	158	800	1472
80	176	900	1652
90	194	1000	1832
100	212	2000	3632

System International (SI)		
Basic size	Basic unit	Symbol
Length	meter	m
Mass	kilogram	kg
Time	second	s
Electric current	ampere	A
Thermodynamic temperature	kelvin	K
Luminous intensity	candela	cd
Amount of substance	mole	mol

1 at	= 0.981 bar = 0.981 x 10 ⁵ Pascal (Pa)
1 kp	= 9.81 Newton (N)
1 PS	= 0.746 kW
0 °C	= 273 Kelvin (K)

mm	inch	mm	inch	mm	inch	mm	inch	mm	inch
0.0254	0.001	0.4318	0.017	0.8382	0.033	1.2192	0.048	1.6256	0.064
0.0508	0.002	0.4572	0.018	0.8636	0.034	1.2446	0.049	1.6510	0.065
0.0762	0.003	0.4826	0.019	0.8890	0.035	1.2700	0.050	1.6764	0.066
0.1016	0.004	0.5080	0.020	0.9144	0.036	1.2954	0.051	1.7018	0.067
0.1270	0.005	0.5334	0.021	0.9398	0.037	1.3208	0.052	1.7272	0.068
0.1524	0.006	0.5588	0.022	0.9652	0.038	1.3462	0.053	1.7526	0.069
0.1778	0.007	0.5842	0.023	0.9906	0.039	1.3716	0.054	1.7780	0.070
0.2032	0.008	0.6096	0.024	1.0000	0.0394	1.3970	0.055	1.8034	0.071
0.2286	0.009	0.6350	0.025	1.0160	0.040	1.4224	0.056	1.8288	0.072
0.2540	0.010	0.6604	0.026	1.0414	0.041	1.4478	0.057	1.8542	0.073
0.2794	0.011	0.6858	0.027	1.0668	0.042	1.4732	0.058	1.8796	0.074
0.3048	0.012	0.7112	0.028	1.0922	0.043	1.4986	0.059	1.9050	0.075
0.3302	0.013	0.7366	0.029	1.1176	0.044	1.5240	0.060	1.9304	0.076
0.3556	0.014	0.7620	0.030	1.1430	0.045	1.5494	0.061	1.9558	0.077
0.3810	0.015	0.7874	0.031	1.1634	0.046	1.5748	0.062	1.9812	0.078
0.4064	0.016	0.8128	0.032	1.1938	0.047	1.6002	0.063	2.0000	0.0787

Environment.

Our contribution to nature.

The living standard of future generations depends on how we maintain the natural environment. We believe that an active environmental policy makes a significant contribution to the improvement of our business position, as we do not consider business success at the cost of nature and the environment to be sustainable. We continuously monitor the effectiveness of our environmental policies and our environmental management system with regular internal and external audits. The company is certified under DIN EN ISO 14001 and EMAS III. Dentaureum has also been a member of the German work group for environmentally-conscious management (B.A.U.M.) since 1995 and has received an award as an environmentally-conscious company as a result of an ecological weak-point analysis. We issue regular announcements on our environmental activities and achievements in our environmental statements.





Alphabetical index

1, 2, 3	Page
3-prong pliers	356–357
A	Page
Adams pliers	356–357
• Acrylics, orthodontics	332–338
Accessories	343–347
Decal	339–342
Disco glitter	338
Orthocryl® – acrylics	335–337
Orthocryl® LC – light-curing acrylic	332–334
Activator screw	304, 312
Adams clasp	292
Aderer pliers	355, 358
Adhesive coated strips for casting ring	243
Adhesive for plastic pattern	238
Adjustable stand	369
Aesthetic wax	182
Alginate	278
Aloxine point	254
Aluminum oxide	391
Analyzing rod	385
Angle wire bending pliers	354
Appliance container	348–349
Arch forming pliers	357
Argon fitting	372
Armrest cushion	372
Arrow clasp	293
Arrow clasp former, arrow clasp bending pliers	357
Arrows to indicate the opening direction	324
Assistant 3000, spot welding unit	374
B	Page
Ball retainer clasp	293
Bertoni expansion screw	308–309
Bite registration wax	280, 344
black & white, Orthocryl	336
Blasting abrasive	391
Blocking-out material (Gumex N)	229
Blocking-out tip	385

Blocking-out unit	384
Blocking-out wax	237
Bonyhard clasp	232, 239
Brush, pointed	269
Bur stand	271
Burs	255–258
C	Page
CAD/CAM material	126–140
Carbon fibre chips	118
Carbon insert	377
Cast partial denture alloy	203, 208–211
Cast partial denture investment material	205, 216–219, 221
Cast partial denture wax	232–237
Casting metal, titanium	166–167, 212–213
Casting ring	185, 186, 242
Casting ring base	185, 186
Casting ring tongs	185, 243, 359
Casting unit and accessories	380–383
Casting wax	183
Castorit® all speed	175
Castorit®-super C	176
Centrifugal casting unit	380
Ceramic accessories, ceraMotion®	34, 116–118
Ceramic crucible	381, 383
Ceramic seal	383
Ceramics and accessories	18–119
ceraMotion® press invest	178
ceraMotion® veneering and press ceramic	18–119
• ceraMotion® One Touch	22–25
Set	22
2D, 3D paste	23
Gingival	24
Glaze	25
• ceraMotion® LiSi	28–29
• ceraMotion® PZr	30–31
• ceraMotion® P+PMe	32–33
• ceraMotion® Zr	38–57
Set	38–43
Dentin	45–47

Alphabetical index

Incisal	48–51	Cloth polishing brush	268
Value Concept	50–51	CoCr alloy	126–127, 150–151, 156–162
Chroma Concept	52	CoCr milling blank	126–127, 157–158
Touch Up	53	CoCr soldering rod	168, 214
Correction	54	CoCr welding wire	170, 215, 369
Glaze	54	Cold model hardener	180, 221, 231
• ceraMotion® Me	58–83	Conical pin, wax	187
Set	58–64	Contrast marker	57, 82, 102, 115
Opaque	65–66	Conversion charts	414
Dentin	67–69	Cord with safety lock	349
Incisal	70–73	Corundum	391
Value Concept	72–73	Corundum disc for model trimmer	389
Chroma Concept	74–75	Courses and Events	406–411
Touch Up	76–77	Covering material (Gumex N)	229
Correction	78	Crown and bridge investment materials at a glance	154–155, 173–180
Glaze	78	Crown Master forceps	271, 358
• ceraMotion® Ti	84–103	Crowns and bridges, NiCr alloy	149, 163–165
Set	84–88	Crowns and bridges, wax	181–184
Bonder	89	Crozat wire	291
Opaque	89–90	Crucible	381, 383
Dentin	91–93	Crucibles and accessories	381, 383
Incisal	94–95	Cutters	255–258
Chroma Concept	97	D	Page
Touch Up	98	Decals, orthodontics	339–342
Correction	99	Dentaflux®	169, 215, 378
Glaze	99	Dental stone	188, 244, 279
• ceraMotion® Lf	104–115	Dermatril® disposable rubber gloves	346
Set	104	desktop Compact	368
Opaque	105	Diamond bur	259–263
Dentin	106–108	Diamond cleaning stone	261
Incisal	109–110	Diamond disc	260–261, 263, 389
Chroma Concept	111	Diamond polishing paste (Tiger Diamond)	269
Correction	112	Diasint diamond bur	259–260, 261–262
Glaze	112	Diasint diamond disc	260–261, 262
Cervical wax	182	Diasint Zr diamond bur for zirconium dioxide	261–262
Chamois leather	268	Die Lube	187
Chroma Concept set	41, 62, 86		
Chrome cobalt soldering rod	168, 214		
Clamping electrode	376		

Alphabetical index

Dipping wax	182
Disco glitter	338
Dispensing pipette	344
Disposable rubber gloves	346
Dowel pin	188
Dressing stone	254
Dual-wheel model trimmer	389
Dubliform	224
DubliGel	226, 346
Dubliplast®	226
Dublitol®	223
Dublitol® micro	223
Duplicating flask	228
Duplicating gel	207, 223–226, 346
Duplicating material	207, 223–226, 346
Duplikat	225
E	Page
ecosil+	227, 347
Edelweiss polishing paste and liquid	270
Electrodes for spot welding unit	376–377
Electropolishing solution	244
Emery cloth	264
Expansion screw	300–304
Expansion screw key	324
Expansion screw sample kit	324
Extraction	346, 390
F	Page
Fan-type expansion screw	310
File	378
Fine investment	222
Finishing paste	269
Fixing ring	186
FKO-Split-Post Fixator	345
Flexaponal®	280
Flexible forward thrust double plate system acc. to Schaneng	311
Flux	168, 169, 215, 378
Foil for Folident thermoforming	187
Foot switch for spot welding unit	376

Forward thrust double plate system acc. to Schaneng	311
Funnel	343
Fuse for spot welding unit	378
G	Page
Gingival material	24, 50, 53, 72, 77, 96, 110
Glaze material	25, 54, 78, 99, 112
Graphite holder	385
Graphite insert	381
Grid strengthener	281, 295
Grinding disc	252
Grinding point	253–254
Grinding wheel	252
Gumex N	229
H	Page
Hand electrode for spot welding unit	376
Hard metal bur and cutter	255–258
Heat protection	215, 378
Heating plate	346, 390
Holder for burs and cutters	271
Holder for hand electrodes for spot welding unit	376
Hotlines	13
hyrax® click expansion screw	320–321
hyrax® expansion screw	319–323
I	Page
Implantology	190–195
Impression material	278
Investing system	185–186, 242
Investment material for press ceramic	178
Investment material for titanium	221
Investment material, cast partial dentures	205, 216–219
Investment material, crowns and bridges	154–155, 173–178
J	Page
Joining wax	237
Junior 3000, spot welding unit	373
K	Page
Kera-Vlies®	185

Alphabetical index

• Keys	
Expansion screw key	324
Safety key hyrax® / Variety	324
Universal bending key	324
Knowledge	394–405
L	Page
Labial arch	292
Laser welding units and accessories	368–372
Light-curing orthodontic acrylics	332–334
Liner	30, 44, 52
Liner for metal casting ring	185, 243
Lingual bar	294
Lining paper	243
Liquids (Ceramics)	25, 56, 80–81, 101, 114
Lithium disilicate ceramic	28–29
Loop forming pliers	354
Low-fusing ceramic, ceraMotion® Lf	104–115
Lubrofilm®	187, 231
M	Page
Magnetic holder	271
Maintenance and protection of pliers	360
Maintenance and protection oil for pliers and instruments	360
Mandrel	264
Marking pencil	238, 282
Master 3000, spot welding unit	375
Matrix band	282
Measuring beaker	244, 343
Medical-grade white oil	360
megapuls compact	380
Metal ceramic, ceraMotion® Me	58–83
Milling blank	126–135, 157–158
Milling wax	182
Mini-Torch	392
Mixing bowl	188, 244, 279
Mixing bowl, silicone	280, 343
Model and casting ring tongs	185, 243, 359
Model gloss	279

Model hardener	221, 231
Model table	386
Model trimmer	389
Modeling wax	181, 280, 344
Mosquito forceps	358
N	Page
Nacera® Blue X set	138
Nacera® Calibrate	139
Nacera® Classic Liquid	136–137
Nacera® Clean	139
Nacera® milling blank	131–135
Nacera® Pearl Multi-Shade	132
Nacera® Pearl Q ² Multi-Shade	131
Nacera® Pearl Shaded 16+2	133
Nacera® Pearl white	134
Nacera® Shell white	135
Nacera® zirconium oxide	131–140
Neo-Star	230
NiCr alloy	149, 163–165
NiCr Sold 1	168
NiCr welding wire	170, 370
Noninium® clasp	292–293
Noninium® wire and clasp	290, 292–293
O	Page
o-atlas II	398–399
Online Shop	8–9
Orthalgenat® Duo	278
Orthalgenat® Ex	278
• Orthocryl® – acrylic	335–338
Accessories	343–347
Assortment	335
black & white	336
Color concentrate	337
Decal	339–342
Disco glitter	338
Neon	335, 336
Single pack	336–337
• Orthocryl® LC – light-curing acrylic	332–334
Accessories	334

Alphabetical index

Single pack	333
Starter set	332
Orthodontic acrylics	332–338
Orthodontic acrylics, light-curing	332–334
P	Page
Palatal cup brush	268
Paralax	372
Paraline	384
Parallel holder	172, 372
Paratherm	384
Pipette	344
Piston spring screw	313
Plaster trimmer	389
Plastic bars	240
Plastic pattern	239–241
Plastic retentions	240, 241
Plastic sheet	241
Pliers	354–359
Pointed beak pliers	355–357
Polish	269–271
Polishing beads	391
Polishing brushes	267, 268, 269
Polishing paste	269–270
Polyclav®	345, 390
Power Liquid	177, 220
Preformed clasp, plastic	239
Preformed clasp, wax	232
Pregrinding media	253
Premium-Line pliers	354–357
Preparation wax	235
• Press/press-on ceramic, ceraMotion®	26–35
ceraMotion® LiSi	28–29
ceraMotion® P+PMe	32–33
Press ingot	28–29, 31, 33
Press investment material	178
Press plunger	34, 179
Press-on ceramic, ceraMotion® PZr	30–31
Pressure hose	345, 390
Pressure vessel	345, 390

Progenia screw	312
R	Page
Rapidur®	188, 244, 279
Rapid/early palatal expansion screws	315–323
Reamer	314
rema® blue	216
rema® cast partial denture investment material	205, 216–221
rema® CC	173
rema® dynamic S	217
rema® Exakt	219
rema® Exakt F	218
rema® Flux 1	168, 215
rema® Form	229, 242
rema® Sil	227
rema® TT	174
Remadur	231
remaloy® wire	291
remanium® 2000+	160
remanium® 2001	161
remanium® C+B alloy	149–151, 156–165
remanium® cast partial denture alloy	203, 208–211
remanium® CS+	163
remanium® CSe	164
remanium® G-soft	165
remanium® GM 280	211
remanium® GM 380+	209
remanium® GM 800+	208
remanium® GM 900	210
remanium® kompendium	396–397
remanium® LFC	162
remanium® segura	159
remanium® star	126–127, 156–158
remanium® star milling blank	126–127, 157–158
remanium® wire	288–290
rematitan® bar	172
rematitan® cold model hardener	180, 221
rematitan® expansion screw	303, 319
rematitan® finishing kit	272

Alphabetical index

rematitan® M	167, 213
rematitan® Plus	180
rematitan® wire	170–171, 319, 370–371
Replacement graphite marker	385
Retainer clasp	293
Retraction screw	307–308
Ring former	34, 179
RK 3 fine investment	222
RK-DUR fine investment	222
RPE screw	319–323
Rubber polisher	265–266
S	Page
Sample former	118
Saw	189, 345
Scissors	358
Screwdriver	314, 378
Sectional screw	305–306, 308–309
Separating disc	250–252
Separating medium	118, 187, 280, 344
Septisol	231
Shade Disc	38, 40–43, 58, 60–64, 84, 86–88, 104, 116–117
Shade Guide A-D	117
Side cutter	358
Side cutter, heavy gauge	358
Silichrom polisher	265
Silicone	227, 347
Silicone mixing bowl	280, 343
Silicone polisher	267
Silicone surface reducing agent	187, 231
Siliform	229
Silver filler	169, 214, 379
Sinter diamond trimmer	263
Snap hooks	349
Soldering carbon for hand electrode for spot welding units	376
Soldering electrode for spot welding unit	377

Soldering rod	168, 214
Solders	168–169, 214, 379
Special screw	305–314
Special tooth-arch concentrate	220
Special wax	280
Spot welding unit	373–375
Spray bottle	343
Spray nozzle	343
Sprue	243
Sprue bar, wax	183
Sprue former	185, 186, 228, 242
Stainless steel brush	268, 269
Stainless steel expansion screw	300–303, 304–310, 315–318, 320–323
Stains	43, 55, 64, 79, 88, 100, 113
Stains Universal Set	43, 64, 88
Stand for pliers	360
Stand for wires and pliers	360
Stand, adjustable	369
StarWax program	181–182
Sticky wax	183, 344
Supercut separating disc	250–251
Surveying equipment and accessories	384–386
T	Page
Table with integrated water tank and pump	382
Tap	228, 347
Thermo wax	344
Thermoforming set	187
Thermomat	387
Three dimensional screw	308–309
Tiger Brilliant polishing paste	269
Tiger Diamond polishing paste	269
Tiger Starshine finishing paste	269
Tin foil	282
Titan hyrax® expansion screw	319
Titanium bar	172
Titanium ceramic, ceraMotion® Ti	84–103

Alphabetical index

Titanium disc	371
Titanium disc holder	371
Titanium wire	170–171, 319, 370–371
Titanium, casting metal	166–167, 212–213
Titanium, expansion screw	303
Titanium, finishing kit	272
Titanium, investment material	180, 221
Titanium, milling blank	128–129
Touch Up	42, 53, 63, 76–77, 87, 98
Transpa material (ceramics)	48–49, 51, 70–71, 73, 94–95, 109
Triangular clasp	293
Tritan	166, 212
Trivest	177
Tungsten electrode	372
TX, TX-Flex separating disc	251
U	Page
Ultrasonic cleaning solution	283
Undercut gauge	385
Universal bending key for expansion screw	324
Universal silver solder	169, 214, 379
V	Page
Variety expansion screw	315–318
W	Page
Wax	181–184, 232–237, 280, 344
Wax clasp	232
Wax knife	386, 387
Wax milling blank	130
Wax pattern	184, 234–235
Wax retention	233
Wax sheet	235–237, 280, 344
Wax stick	184
Wax surface reducing agent	187, 231
Wax template	232–233
Wax wire	184, 234

Wax-Fix	238
Wax-up tool	388
Welding unit and accessories	368–379
Welding wire	170–171, 215, 319, 369–371
White gold solder	169, 214, 379
Wire	170–171, 215, 319, 369–371
Wire bending pliers	356
Wire element	292–295
Wire mesh	281, 295
Z	Page
Zirconium dioxide, diamond bur	261–262
Zirconium oxide ceramic, ceraMotion® Zr	38–57
Zirconium oxide milling blank	131–135

Numerical index

REF	Page	REF	Page	REF	Page	REF	Page
000-730-00	358	081-101-00	376	090-606-00	382	100-205-12	129
001-002-00	354	081-204-00	376	090-610-00	381	100-205-15	129
001-650-00	354	081-205-00	376	090-611-00	381	100-205-20	129
003-053-00	354	081-206-00	376	090-615-00	381	102-001-10	203, 209
003-094-00	355	081-501-00	376	090-620-00	380	102-200-10	203, 208
003-139-00	354	081-601-00	376	091-100-00	389	102-250-00	203, 210
003-180-01	357	081-701-00	376	091-101-00	389	102-280-00	203, 211
003-200-00	357	083-100-00	378	091-102-00	389	102-302-00	149, 168
003-201-00	356	083-300-00	378	091-105-00	389	102-304-00	168, 214, 215
003-202-00	357	084-100-00	378	094-270-00	384	102-306-00	151, 168, 203, 214
003-233-00	354	085-000-00	377	094-272-00	384, 386	102-401-00	149, 163
003-290-00	356	085-100-00	377	094-275-00	384, 385	102-401-05	149, 164
003-515-00	355	085-200-00	377	094-276-00	385	102-402-00	149, 163
003-516-00	355	085-300-00	377	094-277-00	384, 385	102-403-00	149, 163
004-095-00	355	085-400-00	377	094-278-00	385	102-403-05	149, 164
004-139-00	354	086-000-00	377	094-279-00	385	102-600-01	151, 161
004-455-00	356	086-100-00	377	094-280-00	385	102-600-02	151, 161
004-515-00	355	086-200-00	377	094-281-00	385	102-600-10	151, 160
007-024-00	358	086-300-00	377	094-283-00	384, 385	102-601-10	151, 160
008-025-00	358	086-340-00	384, 386	094-284-00	384, 385	102-602-10	151, 160
012-074-00	356	089-430-00	271	094-285-00	384, 385	102-620-00	151, 156
012-520-00	357	089-431-00	271	094-286-00	384, 385	102-621-00	151, 156
012-521-00	357	089-602-00	386, 388	094-287-00	384, 385	102-622-00	151, 156
012-523-00	358	089-603-00	388	094-288-00	384, 385	102-630-00	151, 159
013-522-00	356	089-604-00	388	094-289-00	384, 385	102-631-00	151, 159
033-452-00	355	089-605-00	388	094-290-00	384	102-632-00	151, 159
035-455-00	356	089-606-00	388	094-538-00	392	102-640-00	151, 162
043-700-00	238, 282	089-612-00	388	094-610-00	283	102-642-00	151, 162
043-720-00	325	089-615-00	387	094-611-00	283	102-650-00	126, 157
043-800-00	282	089-620-00	387, 388	094-612-00	283	102-651-00	126, 157
043-900-00	282	090-012-60	383	095-062-00	392	102-652-00	126, 157
044-177-00	358	090-027-00	186, 228	095-063-00	392	102-653-00	126, 157
055-000-00	360	090-110-00	383	095-064-00	392	102-654-00	126, 157
055-100-00	360	090-160-00	383	097-400-01	392	102-750-01	127, 158
055-101-01	360	090-161-00	383	100-001-00	149, 165	102-751-01	127, 158
055-201-00	360	090-161-50	383	100-100-50	166, 212	102-752-01	127, 158
070-000-00	345, 346, 390	090-162-00	383	100-101-50	166, 212	102-753-01	127, 158
070-700-00	345, 390	090-401-00	372	100-102-50	166, 212	102-754-01	127, 158
070-900-00	346, 390	090-404-00	372	100-103-50	166, 212	102-755-01	127, 158
072-001-00	346, 390	090-513-10	372	100-105-50	166, 212	102-756-01	127, 158
072-001-30	346, 390	090-520-00	372	100-107-00	167, 213	102-757-01	127, 158
072-004-00	345	090-525-00	371	100-202-10	128	104-400-50	222
077-000-00	373	090-526-00	371	100-202-12	128	104-501-50	222
078-000-00	374	090-574-00	369	100-202-15	128	105-008-50	205, 218
079-000-00	375	090-578-50	368	100-202-20	128	105-020-00	205, 219
080-116-00	376	090-581-00	375	100-205-10	129	105-020-50	205, 218

Numerical index

REF	Page	REF	Page	REF	Page	REF	Page
105-020-80	205, 219	107-601-00	180, 221	111-303-00	234	117-150-00	236
105-021-00	205, 219	107-602-00	180, 221	111-304-00	234	117-160-00	236
105-021-50	205, 218	107-610-00	180, 221	111-306-00	234	117-235-00	237
105-501-00	205, 218, 219	108-500-00	207, 224	111-308-00	234	117-240-00	237
105-502-00	155, 177, 205, 220	108-550-00	207, 224	111-311-00	235	117-245-00	237
105-600-50	205, 217	108-600-00	207, 225	111-312-00	235	117-250-00	237
105-609-50	205, 217	108-605-00	207, 225	111-313-00	234	117-260-00	237
105-610-50	205, 217	108-610-00	207, 223	111-314-00	234	118-040-00	237
105-610-85	205, 217	108-615-00	207, 223	111-315-00	183	118-045-00	237
105-620-50	205, 217	108-700-00	227	111-425-00	184, 234	118-050-00	237
105-621-00	220	108-701-00	227	111-430-00	184, 234	118-060-00	237
105-623-50	205, 217	108-703-10	227, 347	111-435-00	184, 234	119-150-00	280, 344
105-720-00	205, 216	108-704-10	227, 347	111-440-00	184, 234	120-023-00	235
105-730-00	205, 216	108-705-10	227, 347	111-450-00	184, 234	120-024-00	235
105-731-00	205, 216	108-706-10	227, 347	111-630-00	184	120-025-00	235
105-741-00	155, 175	108-710-00	227	111-640-00	184	120-026-00	235
105-742-80	155, 175	108-711-00	227	111-650-00	184	120-027-00	235
105-745-00	155, 175	108-716-00	228, 347	111-720-00	184, 234	120-104-00	235
105-840-00	155, 173	108-720-50	231	111-825-00	184, 234	120-105-00	235
105-841-00	155, 173	108-721-50	231	111-830-00	184, 234	120-106-00	235
105-845-00	155, 173	110-001-00	232	111-835-00	184, 234	120-107-00	235
105-846-00	155, 173	110-002-00	232	111-840-00	184, 234	120-131-00	187
105-995-00	244	110-003-00	232	111-850-00	184, 234	120-132-00	187
106-704-00	155, 176	110-005-00	232	111-901-00	187	120-170-00	344
106-706-00	155, 177	110-006-00	233	112-000-00	187	120-201-00	181
106-707-00	155, 174	110-011-00	233	112-050-00	187, 231	120-202-00	181
106-721-00	155, 176	110-012-00	233	112-051-00	187, 231	120-203-00	181
106-731-00	155, 177	110-013-00	232	114-420-00	236	120-204-00	181
106-740-00	155, 174	110-101-00	233	114-425-00	236	120-205-00	181
106-800-00	185	110-102-00	233	114-430-00	236	120-206-00	181
106-801-00	185	110-103-00	233	114-435-00	236	120-207-00	181
106-802-00	185	110-201-00	243	114-440-00	236	120-208-00	181
106-820-00	185	110-210-00	238	114-450-00	236	120-211-00	182
106-821-00	185	110-301-00	237	114-460-00	236	120-212-00	182
106-822-00	185	110-310-00	237	114-470-00	236	120-213-50	182
106-825-00	185	111-106-00	184, 234	114-480-00	236	120-230-00	130
106-840-00	186	111-108-00	184, 234	114-500-00	236	120-235-00	130
106-841-00	186	111-109-00	184, 234	117-035-00	236	122-300-00	183, 344
106-842-00	186	111-110-00	184, 234	117-040-00	236	123-580-00	255
106-845-00	186	111-112-00	184, 234	117-045-00	236	123-581-00	255
106-846-00	186	111-115-00	184, 234	117-050-00	236	123-582-00	255
106-847-00	186	111-120-00	184, 234	117-060-00	236	123-583-00	255
106-850-01	186	111-216-00	233	117-130-00	236	123-584-00	255
106-851-01	186	111-217-00	233	117-135-00	236	123-585-00	255
106-852-01	186	111-218-00	233	117-140-00	236	123-586-00	255
107-600-00	180, 221	111-301-00	234	117-145-00	236	123-588-00	255

Numerical index

REF	Page	REF	Page	REF	Page	REF	Page
123-590-00	255	127-251-00	185	130-513-00	252	138-302-00	265
123-591-00	255	127-306-00	242	130-634-00	252	138-303-00	265
123-592-00	256	127-307-00	242	130-824-00	252	138-501-00	266
123-593-00	256	127-308-00	242	131-322-50	252	138-601-00	266
123-594-00	257	127-309-00	229, 242	132-201-00	253	138-602-00	266
123-596-00	257	127-310-00	242	132-202-00	253	138-603-00	266
123-597-00	258	127-311-00	228, 242	132-203-00	253	138-605-00	266
123-598-00	258	127-312-00	228, 242	132-204-00	253	138-606-00	267
123-600-00	256	127-315-00	229	132-205-00	253	138-620-00	267
123-601-00	256	127-316-00	229	132-801-00	254	138-623-00	267
123-602-00	256	127-317-00	229	132-802-00	254	138-640-00	265
123-610-00	257	127-318-00	229	132-803-00	254	138-645-00	265
123-611-00	257	127-400-00	243, 359	132-804-00	254	139-100-00	264
123-612-00	257	127-410-00	185, 243, 359	134-000-00	253	139-300-00	264
123-613-00	257	127-870-00	268	135-500-00	272	139-301-00	264
123-800-00	183	127-922-00	269	135-851-00	254	139-500-00	264
124-002-00	280	127-922-10	269	135-852-00	254	140-015-00	264
124-003-00	280	128-010-00	391	135-853-00	254	140-016-00	264
124-202-00	280	128-011-00	391	135-855-00	254	141-700-00	267
125-140-00	238	128-015-00	391	137-807-00	261	141-700-10	267
125-250-50	239	128-016-00	391	137-810-00	261	141-710-00	267
125-251-50	239	128-017-00	391	137-820-00	259	141-711-00	267
125-252-50	239	128-020-00	391	137-821-00	259	141-712-00	267
125-256-50	239	128-211-00	391	137-822-00	259	141-713-00	268
125-257-50	239	128-301-00	244	137-823-00	259	141-713-10	268
125-258-50	239	128-401-00	244	137-824-00	259	141-800-00	269
125-259-50	239	130-101-00	250	137-825-00	259	141-810-00	269
125-260-50	239	130-101-40	250	137-826-00	260	142-100-50	168, 214
125-261-50	239	130-102-00	250	137-827-00	260	150-010-00	278
125-264-50	240	130-102-40	250	137-828-00	260	150-501-20	278
125-265-50	240	130-103-00	250	137-829-00	259	150-501-30	278
125-269-50	240	130-103-40	250	137-830-00	259	150-509-20	278
125-270-50	240	130-111-00	251	137-831-00	260	150-509-30	278
125-272-50	240	130-111-40	251	137-840-00	262	150-520-20	278
125-273-50	240	130-112-00	251	137-841-00	261, 262	150-520-30	278
125-275-50	241	130-112-40	251	137-842-00	262	160-011-00	336
125-276-50	241	130-113-00	251	137-843-00	262	160-012-00	336
125-280-50	241	130-113-40	251	137-844-00	262	160-013-00	336
126-221-00	241	130-114-00	251	137-850-00	260	160-014-00	336
126-222-00	241	130-115-00	250	137-855-00	260	160-100-00	339
126-226-00	241	130-131-00	252	137-856-00	261	160-100-01	339, 34
126-231-00	241	130-137-00	252	137-900-00	254	160-100-02	339, 34
126-232-00	241	130-138-00	252	138-101-00	266	160-100-04	339, 34
127-010-00	243	130-324-00	252	138-102-00	265	160-100-05	339, 341
127-100-00	243	130-511-00	251	138-103-00	265	160-100-06	339, 341
127-250-00	185	130-512-00	251	138-301-00	266	160-100-07	339, 341

Numerical index

REF	Page	REF	Page	REF	Page	REF	Page
160-100-09	339, 341	161-127-00	335, 337	163-704-01	348	190-200-00	270
160-100-10	339, 341	161-128-00	335, 337	163-705-01	348	190-301-00	269
160-100-11	339, 341	161-129-00	335, 337	163-706-01	348	190-302-00	269
160-100-12	339, 341	161-130-00	335, 337	163-707-01	348	190-350-00	269
160-100-13	339, 341	161-131-00	337	163-708-01	348	190-350-50	269
160-100-14	339, 341	161-132-00	337	163-709-01	348	210-010-00	172
160-100-15	339, 341	161-133-00	337	163-801-00	349	210-011-00	172
160-100-16	339, 342	161-134-00	337	163-802-01	348	210-012-00	172
160-100-18	339, 342	161-135-00	335, 336	163-803-01	348	210-013-00	172, 372
160-100-19	339, 342	161-136-00	335, 336	163-805-01	349	210-020-00	172
160-100-27	339, 342	161-137-00	335, 336	163-807-00	349	210-021-00	172
160-100-28	342	161-138-00	335, 336	164-450-00	188, 244, 279	210-022-00	172
160-100-29	339, 342	161-150-00	337	164-650-00	188, 244, 279	210-023-00	172, 372
160-100-30	342	161-300-00	337	164-651-00	188, 244, 279	250-001-20	44
160-100-31	339, 342	161-350-00	337	165-500-00	207, 226	250-001-40	44
160-100-34	342	161-605-00	338	165-501-00	207, 226, 346	250-002-20	44
160-100-39	339	161-606-00	338	165-550-00	207, 226	250-002-40	44
160-100-40	339	161-607-00	338	165-700-00	228	250-003-20	44
160-100-41	339	161-608-00	338	165-810-00	230	250-003-40	44
160-100-42	340	161-609-00	338	165-839-00	230	250-004-20	44
160-100-43	340	161-611-00	338	165-850-00	230	250-004-40	44
160-100-44	340	161-620-00	337	165-851-00	230	250-005-20	44
160-100-45	339, 342	161-622-00	337	165-852-00	230	250-005-40	44
160-100-46	340	161-912-00	335	165-853-00	230	250-006-20	44
160-112-00	335, 336	162-100-00	335, 343	165-854-00	230	250-006-40	44
160-212-00	335, 336	162-101-00	344	165-855-00	230	250-018-20	44
160-300-00	336	162-200-00	335, 343	165-856-00	230	250-019-20	44
160-301-00	336	162-501-00	280, 343	165-857-00	230	250-021-20	38, 45
160-400-00	332	162-502-00	280, 343	165-858-00	230	250-021-40	45
160-400-20	332	162-503-00	280, 343	165-860-00	230	250-022-20	38, 39, 45
160-401-00	332, 333	162-600-00	335, 343	166-450-00	279	250-022-40	45
160-402-00	332, 333	162-750-01	343	167-215-00	231	250-023-20	38, 39, 45
160-403-00	332, 333	162-751-00	335, 343	167-301-00	231	250-023-40	45
160-404-00	332, 333	162-752-00	335, 343	167-305-00	180, 221	250-024-20	38, 45
160-405-00	332, 333	162-800-00	280, 334, 335, 344	168-015-50	229	250-024-40	45
160-406-00	332, 333	162-907-00	346	180-201-00	258	250-025-20	45
160-410-00	334	162-908-00	346	180-202-00	258	250-025-40	45
160-420-00	332, 334	162-909-00	346	180-304-00	258	250-026-20	45
160-421-00	332, 334	163-602-01	348	180-305-00	258	250-026-40	45
160-422-00	334	163-603-01	348	180-308-00	257	250-027-20	38, 39, 45
160-430-00	334	163-604-01	348	180-702-00	189, 345	250-027-40	45
160-501-00	335	163-605-01	348	180-703-00	189, 345	250-028-20	38, 45
160-502-00	335	163-606-01	348	181-100-01	268	250-028-40	45
160-600-00	335	163-609-01	348	181-200-00	268	250-029-20	45
160-700-00	335	163-702-01	348	181-201-00	268	250-029-40	45
161-100-00	335, 337	163-703-01	348	190-100-00	270	250-030-20	45

Numerical index

REF	Page	REF	Page	REF	Page	REF	Page
250-030-40	45	250-060-40	48	250-123-20	38, 49	250-301-03	22, 23
250-031-20	45	250-061-20	38, 39, 48	250-124-20	49	250-302-03	22, 23
250-031-40	45	250-061-40	48	250-125-20	40, 49	250-303-03	22, 23
250-032-20	38, 45	250-062-20	48	250-221-20	52	250-304-03	22, 23
250-032-40	45	250-062-40	48	250-222-20	52	250-305-03	22, 23
250-033-20	45	250-065-20	38, 48	250-223-20	52	250-306-03	22, 23
250-033-40	45	250-065-40	48	250-224-20	41, 52	250-307-03	22, 23
250-034-20	45	250-066-20	38, 48	250-231-20	41, 52	250-308-03	22, 23
250-034-40	45	250-066-40	48	250-232-20	41, 52	250-309-03	22, 23
250-035-20	38, 45	250-067-20	48	250-233-20	41, 52	250-310-03	22, 23
250-035-40	45	250-067-40	48	250-234-20	41, 52	250-311-03	22, 23
250-036-20	45	250-070-20	38, 39, 48	250-235-20	41, 52	250-312-03	22, 23
250-036-40	45	250-070-40	48	250-236-20	41, 52	250-313-03	22, 23
250-041-20	38, 46	250-071-20	38, 39, 48	250-237-20	41, 52	250-314-03	22, 23
250-041-40	46	250-071-40	48	250-238-20	41, 52	250-350-00	25
250-042-20	38, 39, 46	250-072-20	48	250-239-20	41, 52	250-401-20	30
250-042-40	46	250-072-40	48	250-240-20	41, 52	250-402-20	30
250-043-20	38, 39, 46	250-075-20	38, 39, 49	250-241-20	41, 52	250-403-20	30
250-043-40	46	250-075-40	49	250-242-20	41, 52	250-404-20	30
250-044-20	38, 46	250-081-20	50	250-245-20	41, 52	250-405-20	30
250-044-40	46	250-082-20	50	250-251-20	42, 53	250-406-20	30
250-045-20	46	250-083-20	50	250-252-20	42, 53	250-407-20	30
250-045-40	46	250-084-20	50	250-253-20	42, 53	250-408-20	30
250-046-20	46	250-085-20	50	250-255-20	42, 53	250-409-20	30
250-046-40	46	250-086-20	50	250-256-20	42, 53	250-410-20	30
250-047-20	38, 39, 46	250-090-20	50	250-257-20	42, 53	250-411-20	30
250-047-40	46	250-091-20	50	250-260-20	42, 53	250-412-20	30
250-048-20	38, 46	250-092-20	50	250-261-20	42, 53	250-413-20	30
250-048-40	46	250-093-20	50	250-262-20	42, 53	250-414-20	30
250-049-20	46	250-095-03	38, 54	250-263-20	53	250-415-20	30
250-049-40	46	250-101-20	45	250-264-20	53	250-416-20	30
250-050-20	46	250-102-20	45	250-270-02	38, 39, 54	250-431-05	31
250-050-40	46	250-103-20	45	250-271-03	22, 25, 54	250-432-05	31
250-051-20	46	250-104-20	45	250-280-20	40, 50	250-433-05	31
250-051-40	46	250-105-20	45	250-281-20	40, 50	250-434-05	31
250-052-20	38, 46	250-106-20	45	250-282-20	40, 50	250-435-05	31
250-052-40	46	250-107-20	45	250-283-20	40, 51	250-436-05	31
250-053-20	46	250-111-20	47	250-284-20	40, 50	250-437-05	31
250-053-40	46	250-112-20	47	250-285-20	40, 51	250-438-05	31
250-054-20	46	250-113-20	47	250-286-20	40, 51	250-439-05	31
250-054-40	46	250-114-20	38, 47	250-287-20	40, 51	250-440-05	31
250-055-20	38, 46	250-115-20	47	250-288-20	40, 51	250-441-05	31
250-055-40	46	250-116-20	38, 47	250-289-20	40, 51	250-442-05	31
250-056-20	46	250-117-20	47	250-290-20	40, 51	250-443-05	31
250-056-40	46	250-121-20	38, 49	250-291-20	40, 51	250-444-05	31
250-060-20	38, 39, 48	250-122-20	38, 49	250-300-03	22, 23	250-445-05	31

Numerical index

REF	Page	REF	Page	REF	Page	REF	Page
250-446-05	31	251-023-40	91	251-050-40	92	251-103-20	91
250-800-25	38	251-024-20	84, 91	251-051-20	92	251-104-20	91
250-800-50	42	251-024-40	91	251-051-40	92	251-105-20	91
250-800-55	41	251-025-20	91	251-052-20	84, 92	251-106-20	91
250-800-60	40	251-025-40	91	251-052-40	92	251-107-20	91
250-800-70	22	251-026-20	91	251-053-20	92	251-111-20	93
250-900-25	39	251-026-40	91	251-053-40	92	251-112-20	93
251-001-20	84, 89	251-027-20	84, 85, 91	251-054-20	92	251-113-20	93
251-001-40	89	251-027-40	91	251-054-40	92	251-114-20	84, 93
251-002-20	84, 85, 89	251-028-20	84, 91	251-055-20	84, 92	251-115-20	93
251-002-40	89	251-028-40	91	251-055-40	92	251-116-20	84, 93
251-003-20	84, 85, 89	251-029-20	91	251-056-20	92	251-117-20	93
251-003-40	89	251-029-40	91	251-056-40	92	251-121-20	84, 95
251-004-20	84, 89	251-030-20	91	251-060-20	84, 85, 94	251-122-20	84, 95
251-004-40	89	251-030-40	91	251-060-40	94	251-123-20	84, 95
251-005-20	89	251-031-20	91	251-061-20	84, 85, 94	251-124-20	95
251-005-40	89	251-031-40	91	251-061-40	94	251-125-20	95
251-006-20	89	251-032-20	84, 91	251-062-20	94	251-221-20	86, 97
251-006-40	89	251-032-40	91	251-062-40	94	251-222-20	86, 97
251-007-20	84, 85, 89	251-033-20	91	251-065-20	84, 94	251-223-20	86, 97
251-007-40	89	251-033-40	91	251-065-40	94	251-224-20	86, 97
251-008-20	84, 89	251-034-20	91	251-066-20	84, 94	251-231-20	86, 97
251-008-40	89	251-034-40	91	251-066-40	94	251-232-20	86, 97
251-009-20	89	251-035-20	84, 91	251-067-20	94	251-233-20	86, 97
251-009-40	89	251-035-40	91	251-067-40	94	251-234-20	86, 97
251-010-20	89	251-036-20	91	251-070-20	84, 85, 94	251-235-20	86, 97
251-010-40	89	251-036-40	91	251-070-40	94	251-236-20	86, 97
251-011-20	89	251-041-20	84, 92	251-071-20	84, 85, 94	251-237-20	86, 97
251-011-40	89	251-041-40	92	251-071-40	94	251-238-20	86, 97
251-012-20	84, 89	251-042-20	84, 85, 92	251-072-20	94	251-239-20	86, 97
251-012-40	89	251-042-40	92	251-072-40	94	251-240-20	86, 97
251-013-20	89	251-043-20	84, 92	251-075-20	84, 85, 95	251-241-20	86, 97
251-013-40	89	251-043-40	92	251-075-40	95	251-242-20	86, 97
251-014-20	89	251-044-20	84, 92	251-081-20	96	251-245-20	86, 97
251-014-40	89	251-044-40	92	251-082-20	96	251-251-20	87, 98
251-015-20	84, 89	251-045-20	92	251-083-20	96	251-252-20	87, 98
251-015-40	89	251-045-40	92	251-084-20	96	251-253-20	87, 98
251-016-20	89	251-046-20	92	251-085-20	96	251-255-20	87, 98
251-016-40	89	251-046-40	92	251-086-20	96	251-256-20	87, 98
251-018-20	90	251-047-20	84, 85, 92	251-090-20	96	251-257-20	87, 98
251-019-20	90	251-047-40	92	251-091-20	96	251-260-20	87, 98
251-021-20	84, 91	251-048-20	84, 92	251-092-20	96	251-261-20	87, 98
251-021-40	91	251-048-40	92	251-093-20	96	251-262-20	87, 98
251-022-20	84, 85, 91	251-049-20	92	251-095-03	84, 99	251-270-02	84, 85, 99
251-022-40	91	251-049-40	92	251-101-20	91	251-550-20	89
251-023-20	84, 91	251-050-20	92	251-102-20	91	251-550-40	89

Numerical index

REF	Page	REF	Page	REF	Page	REF	Page
251-551-03	84, 85, 89	252-024-20	58, 60, 67	252-051-20	68	252-104-20	67
251-551-06	89	252-024-40	67	252-051-40	68	252-105-20	67
251-800-15	84	252-025-20	67	252-052-20	58, 60, 68	252-106-20	67
251-800-45	86	252-025-40	67	252-052-40	68	252-107-20	67
251-800-50	87	252-026-20	67	252-053-20	68	252-111-20	69
251-900-15	85	252-026-40	67	252-053-40	68	252-112-20	69
252-001-20	60, 66	252-027-20	58, 60, 67	252-054-20	68	252-113-20	69
252-001-40	66	252-027-40	67	252-054-40	68	252-114-20	58, 60, 69
252-002-20	60, 66	252-028-20	58, 60, 67	252-055-20	58, 60, 68	252-115-20	69
252-002-40	66	252-028-40	67	252-055-40	68	252-116-20	58, 60, 69
252-003-20	60, 66	252-029-20	67	252-056-20	68	252-117-20	69
252-003-40	66	252-029-40	67	252-056-40	68	252-121-20	58, 60, 71
252-004-20	60, 66	252-030-20	67	252-060-20	58, 60, 70	252-122-20	58, 60, 71
252-004-40	66	252-030-40	67	252-060-40	70	252-123-20	58, 60, 71
252-005-20	66	252-031-20	67	252-061-20	58, 60, 70	252-124-20	71
252-005-40	66	252-031-40	67	252-061-40	70	252-125-20	61, 71
252-006-20	66	252-032-20	58, 60, 67	252-062-20	70	252-221-20	74
252-006-40	66	252-032-40	67	252-062-40	70	252-222-20	74
252-007-20	60, 66	252-033-20	67	252-065-20	58, 60, 70	252-223-20	74
252-007-40	66	252-033-40	67	252-065-40	70	252-224-20	74
252-008-20	60, 66	252-034-20	67	252-066-20	58, 60, 70	252-231-20	62, 75
252-008-40	66	252-034-40	67	252-066-40	70	252-232-20	62, 75
252-009-20	66	252-035-20	58, 60, 67	252-067-20	70	252-233-20	62, 75
252-009-40	66	252-035-40	67	252-067-40	70	252-234-20	62, 75
252-010-20	66	252-036-20	67	252-070-20	58, 60, 70	252-235-20	62, 75
252-010-40	66	252-036-40	67	252-070-40	70	252-236-20	62, 75
252-011-20	66	252-041-20	58, 60, 68	252-071-20	58, 60, 70	252-237-20	62, 75
252-011-40	66	252-041-40	68	252-071-40	70	252-238-20	62, 75
252-012-20	60, 66	252-042-20	58, 60, 68	252-072-20	70	252-239-20	62, 75
252-012-40	66	252-042-40	68	252-072-40	70	252-240-20	62, 75
252-013-20	66	252-043-20	58, 60, 68	252-075-20	58, 60, 71	252-241-20	62, 75
252-013-40	66	252-043-40	68	252-075-40	71	252-242-20	62, 75
252-014-20	66	252-044-20	58, 60, 68	252-081-20	72	252-245-20	62, 75
252-014-40	66	252-044-40	68	252-082-20	72	252-250-03	63, 76
252-015-20	60, 66	252-045-20	68	252-083-20	72	252-251-20	63, 76
252-015-40	66	252-045-40	68	252-084-20	72	252-252-20	63, 76
252-016-20	66	252-046-20	68	252-085-20	72	252-253-20	63, 76
252-016-40	66	252-046-40	68	252-086-20	72	252-255-20	63, 76
252-018-20	66	252-047-20	58, 60, 68	252-090-20	72	252-256-20	63, 76
252-019-20	66	252-047-40	68	252-091-20	72	252-257-20	63, 76
252-021-20	58, 60, 67	252-048-20	58, 60, 68	252-092-20	72	252-260-20	63, 76
252-021-40	67	252-048-40	68	252-093-20	72	252-261-20	63, 76
252-022-20	58, 60, 67	252-049-20	68	252-095-03	58, 60, 78	252-262-20	63, 76
252-022-40	67	252-049-40	68	252-101-20	67	252-263-20	77
252-023-20	58, 60, 67	252-050-20	68	252-102-20	67	252-264-20	77
252-023-40	67	252-050-40	68	252-103-20	67	252-270-02	58, 60, 78

Numerical index

REF	Page	REF	Page	REF	Page	REF	Page
252-280-20	61, 72	252-514-03	32, 65	253-067-20	109	253-607-02	113
252-281-20	61, 72	252-515-03	32, 58, 65	253-075-20	104, 109	253-609-02	113
252-282-20	61, 72	252-516-03	32, 65	253-081-20	110	253-612-02	113
252-283-20	61, 73	252-520-03	65	253-082-20	110	253-613-02	113
252-284-20	61, 72	252-521-03	65	253-083-20	110	253-620-02	113
252-285-20	61, 73	252-541-03	62, 74	253-084-20	110	253-621-02	113
252-286-20	61, 73	252-542-03	62, 74	253-085-20	110	253-622-02	113
252-287-20	61, 73	252-543-03	62, 74	253-086-20	110	253-800-10	104
252-288-20	61, 73	252-544-03	62, 74	253-091-20	110	254-000-02	39, 56, 80, 85, 101, 114
252-289-20	61, 73	252-800-10	58	253-092-20	110		
252-290-20	61, 73	252-800-15	60	253-095-03	104, 112	254-000-10	38, 56, 80, 84, 101, 104, 114
252-291-20	61, 73	252-800-45	62	253-111-20	108		
252-431-05	33	252-800-50	63	253-112-20	108	254-000-50	56, 80, 101, 114
252-432-05	33	252-800-60	61	253-113-20	108	254-001-02	59, 80
252-433-05	33	252-900-15	59	253-115-20	108	254-001-10	58, 60, 80
252-434-05	33	253-021-20	104, 106	253-116-20	104, 108	254-001-50	80
252-435-05	33	253-022-20	104, 106	253-117-20	108	254-002-02	56, 80, 101, 114
252-436-05	33	253-023-20	104, 106	253-121-20	110	254-002-10	56, 80, 101, 114
252-437-05	33	253-024-20	104, 106	253-123-20	110	254-002-50	56, 80, 101, 114
252-438-05	33	253-025-20	104, 106	253-125-20	110	254-004-02	56, 81, 101, 114
252-439-05	33	253-026-20	106	253-231-20	111	254-004-10	56, 81, 101, 114
252-440-05	33	253-027-20	104, 106	253-232-20	111	254-006-02	58, 59, 80, 84, 85, 101, 104, 114
252-441-05	33	253-028-20	106	253-245-20	111		
252-442-05	33	253-029-20	104, 106	253-270-02	104, 112	254-006-10	80, 101, 114
252-443-05	33	253-030-20	106	253-501-03	104, 105	254-008-02	39, 56, 80, 101
252-444-05	33	253-041-20	104, 107	253-502-03	104, 105	254-008-10	38, 56, 60, 80, 84, 101
252-445-05	33	253-042-20	104, 107	253-503-03	104, 105		
252-446-05	33	253-043-20	104, 107	253-504-03	104, 105	254-010-02	38, 39, 43, 56, 58, 60, 64, 81, 84, 85, 88, 101, 104, 114
252-451-05	33	253-044-20	104, 107	253-505-03	105		
252-452-05	33	253-045-20	107	253-506-03	105	254-010-10	56, 81, 101, 114
252-456-05	33	253-046-20	107	253-507-03	104, 105	254-012-01	22, 25
252-457-05	33	253-047-20	104, 107	253-508-03	104, 105	254-014-01	22, 25
252-458-05	33	253-048-20	104, 107	253-509-03	105		
252-501-03	32, 58, 65	253-049-20	107	253-510-03	105	254-100-00	38, 58, 60, 84, 104, 116
252-502-03	32, 58, 59, 65	253-050-20	107	253-511-03	105	254-101-00	116
252-503-03	32, 58, 59, 65	253-051-20	107	253-512-03	104, 105	254-102-00	41, 62, 86, 116
252-504-03	32, 58, 65	253-052-20	104, 107	253-513-03	105	254-103-00	42, 63, 87, 117
252-505-03	32, 65	253-053-20	107	253-514-03	105	254-104-00	117
252-506-03	32, 65	253-054-20	107	253-515-03	104, 105	254-105-00	43, 64, 88, 117
252-507-03	32, 58, 59, 65	253-055-20	104, 107	253-516-03	105	254-106-00	40, 61, 116
252-508-03	32, 58, 65	253-056-20	107	253-520-03	105	254-201-02	43, 55, 64, 79, 88, 100
252-509-03	32, 65	253-060-20	104, 109	253-521-03	105	254-202-02	43, 55, 64, 79, 88, 100
252-510-03	32, 65	253-061-20	104, 109	253-541-03	111	254-203-02	43, 55, 64, 79, 88, 100
252-511-03	32, 65	253-062-20	109	253-550-03	104, 105	254-204-02	43, 55, 64, 79, 88, 100
252-512-03	32, 58, 65	253-065-20	104, 109	253-601-02	113	254-205-02	43, 55, 64, 79, 88, 100
252-513-03	32, 65	253-066-20	104, 109	253-604-02	113	254-206-02	43, 55, 64, 79, 88, 100

Numerical index

REF	Page	REF	Page	REF	Page	REF	Page
254-207-02	43, 55, 64, 79, 88, 100	260-360-10	34, 179	270-012-12	133	270-024-20	133
254-208-02	43, 55, 64, 79, 88, 100	260-360-20	34, 179	270-012-14	133	270-024-25	133
254-209-02	43, 55, 64, 79, 88, 100	260-365-01	34, 179	270-012-16	133	270-031-12	133
254-210-02	43, 55, 64, 79, 88, 100	260-365-05	34, 179	270-012-18	133	270-031-14	133
254-211-02	43, 55, 64, 79, 88, 100	260-365-13	34, 179	270-012-20	133	270-031-16	133
254-212-02	43, 55, 64, 79, 88, 100	260-803-01	263	270-012-25	133	270-031-18	133
254-213-02	43, 55, 64, 79, 88, 100	260-803-02	263	270-013-12	133	270-031-20	133
254-220-02	43, 55, 64, 79, 88, 100	260-803-03	263	270-013-14	133	270-031-25	133
254-221-02	43, 55, 64, 79, 88, 100	260-803-04	263	270-013-16	133	270-032-12	133
254-222-02	43, 55, 64, 79, 88, 100	260-804-01	263	270-013-18	133	270-032-14	133
254-300-02	57, 82, 102, 115	260-804-02	263	270-013-20	133	270-032-16	133
254-301-02	57, 82, 102, 115	260-905-20	22, 25	270-013-25	133	270-032-18	133
254-302-02	57, 82, 102, 115	260-906-20	22, 25	270-014-12	133	270-032-20	133
254-303-02	57, 82, 102, 115	260-907-10	118	270-014-14	133	270-032-25	133
254-304-02	57, 82, 102, 115	270-001-10	134	270-014-16	133	270-033-12	133
254-800-30	43, 64, 88	270-001-12	134	270-014-18	133	270-033-14	133
255-001-05	28	270-001-14	134	270-014-20	133	270-033-16	133
255-002-05	28	270-001-16	134	270-014-25	133	270-033-18	133
255-003-05	28	270-001-18	134	270-015-12	133	270-033-20	133
255-004-05	28	270-001-20	134	270-015-14	133	270-033-25	133
255-012-05	28	270-001-25	134	270-015-16	133	270-034-12	133
255-013-05	28	270-002-10	135	270-015-18	133	270-034-14	133
255-022-05	28	270-002-12	135	270-015-20	133	270-034-16	133
255-023-05	28	270-002-14	135	270-015-25	133	270-034-18	133
255-033-05	28	270-002-16	135	270-021-12	133	270-034-20	133
255-035-05	28	270-002-18	135	270-021-14	133	270-034-25	133
255-041-05	28	270-002-20	135	270-021-16	133	270-042-12	133
255-042-05	28	270-002-25	135	270-021-18	133	270-042-14	133
255-102-05	29	270-009-12	133	270-021-20	133	270-042-16	133
255-111-05	29	270-009-14	133	270-021-25	133	270-042-18	133
255-112-05	29	270-009-16	133	270-022-12	133	270-042-20	133
255-121-05	29	270-009-18	133	270-022-14	133	270-042-25	133
255-122-05	29	270-009-20	133	270-022-16	133	270-043-12	133
255-123-05	29	270-009-25	133	270-022-18	133	270-043-14	133
255-131-05	29	270-010-12	133	270-022-20	133	270-043-16	133
255-132-05	29	270-010-14	133	270-022-25	133	270-043-18	133
255-133-05	29	270-010-16	133	270-023-12	133	270-043-20	133
255-141-05	29	270-010-18	133	270-023-14	133	270-043-25	133
255-142-05	29	270-010-20	133	270-023-16	133	270-044-12	133
260-300-02	271, 358	270-010-25	133	270-023-18	133	270-044-14	133
260-300-03	118	270-011-12	133	270-023-20	133	270-044-16	133
260-300-13	118	270-011-14	133	270-023-25	133	270-044-18	133
260-300-20	117	270-011-16	133	270-024-12	133	270-044-20	133
260-315-00	118	270-011-18	133	270-024-14	133	270-044-25	133
260-317-00	118	270-011-20	133	270-024-16	133	270-050-14	132
260-324-01	118	270-011-25	133	270-024-18	133	270-050-18	132

REF	Page	REF	Page	REF	Page	REF	Page
270-050-22	132	271-011-50	136, 137	308-520-00	289	520-082-10	290
270-051-14	132	271-012-50	136, 137	308-713-00	290	520-090-10	290
270-051-18	132	271-013-50	136, 137	308-715-00	290	520-092-10	290
270-051-22	132	271-014-50	136, 137	308-718-00	290	520-120-10	290
270-052-14	132	271-015-50	136, 137	311-306-30	294	521-040-00	289
270-052-18	132	271-021-50	136, 137	311-307-30	294	523-050-00	289
270-052-22	132	271-022-50	136, 137	311-308-30	294	523-060-00	289
270-053-14	132	271-023-50	136, 137	312-106-00	294	523-070-00	289
270-053-18	132	271-024-50	136, 137	312-107-00	294	523-080-00	289
270-053-22	132	271-031-50	136, 137	316-110-00	281, 295	523-090-00	289
270-054-14	132	271-032-50	136, 137	316-210-00	281, 295	523-100-00	289
270-054-18	132	271-033-50	136, 137	317-110-00	281, 295	523-110-00	289
270-054-22	132	271-034-50	136, 137	317-210-00	281, 295	523-120-00	289
270-055-14	132	271-042-50	136, 137	318-004-00	281, 295	523-150-00	289
270-055-18	132	271-043-50	136, 137	318-104-00	281, 295	524-060-00	289
270-055-22	132	271-044-50	136, 137	319-401-00	188	524-070-00	289
270-056-14	132	271-050-50	136, 137	319-402-00	188	524-080-00	289
270-056-18	132	271-051-20	136, 137	319-405-00	188	524-090-00	289
270-056-22	132	271-052-20	136, 137	324-610-00	282	524-100-00	289
270-057-14	132	271-061-20	136, 137	324-620-00	282	524-110-00	289
270-057-18	132	271-065-20	136, 137	324-725-00	282	525-040-00	288
270-057-22	132	271-071-20	136, 137	324-730-00	282	527-004-00	288
270-060-16	131	271-074-20	136, 137	324-740-00	282	527-005-00	288
270-060-20	131	271-075-20	136, 137	324-750-00	282	527-006-00	288
270-061-16	131	271-090-00	138	324-760-00	282	527-070-00	288
270-061-20	131	271-100-00	136	380-070-00	215, 378	527-080-00	288
270-062-16	131	271-101-00	136, 138	380-600-50	169, 214, 379	527-090-00	288
270-062-20	131	271-102-00	138	380-604-50	169, 214, 379	527-100-00	288
270-070-16	131	271-103-00	138	380-604-60	169, 214, 379	528-039-50	170, 370
270-070-20	131	271-104-00	136, 138	380-704-50	169, 214, 379	528-040-50	170, 370
270-071-16	131	271-105-00	136, 138	385-624-00	290	528-041-00	171, 319, 370
270-071-20	131	271-107-00	136	385-630-00	290	528-042-00	171, 319, 370
270-072-16	131	271-120-00	139	513-070-00	288	528-043-00	171, 371
270-072-20	131	271-122-00	139	513-080-00	288	528-044-00	171, 371
270-084-14	132	271-130-14	140, 270	513-090-00	288	528-050-00	171, 371
270-084-18	132	271-131-14	140, 270	513-100-00	288	528-070-00	291
270-084-22	132	271-135-00	139	513-120-00	288	528-080-00	291
270-085-14	132	271-136-15	139	513-150-00	288	528-090-00	291
270-085-18	132	275-010-00	178	514-070-00	288	528-100-00	291
270-085-22	132	275-015-00	178	514-080-00	288	528-110-00	291
270-086-14	132	291-000-00	118	514-090-00	288	528-120-00	291
270-086-18	132	299-150-40	56, 81	514-100-00	288	528-130-00	291
270-086-22	132	299-150-80	56, 81	520-062-10	290	528-150-00	291
270-087-14	132	308-513-00	289	520-070-10	290	528-155-00	291
270-087-18	132	308-515-00	289	520-072-10	290	528-158-00	291
270-087-22	132	308-518-00	289	520-080-10	290	528-159-00	291

Numerical index

REF	Page	REF	Page	REF	Page	REF	Page
528-200-10	170, 215, 369	600-502-10	305	602-819-10	317	607-202-30	294
528-210-10	170, 215, 369	600-502-30	305	602-819-12	317	607-204-00	294
528-215-10	170, 215, 369	600-502-60	305	602-819-30	317	607-204-30	294
528-220-00	149, 170, 370	600-503-10	305	602-819-32	317	609-004-00	313
535-002-00	288	600-503-30	305	602-830-10	320	609-006-00	313
535-003-00	288	600-503-60	305	602-830-12	320	609-008-00	313
535-005-00	288	600-600-30	308	602-830-30	320	609-100-00	313
535-009-00	288	600-601-30	307	602-830-32	320	609-200-30	313
600-000-00	311	600-602-30	307	602-831-10	320	609-300-00	313, 314
600-001-00	311	600-610-00	312	602-831-30	320	609-400-00	313, 314
600-001-30	311	600-610-30	312	602-832-10	320	609-500-00	313
600-002-00	311	602-604-10	309	602-832-12	320	611-115-00	324
600-002-30	311	602-605-10	308	602-832-30	320	611-115-30	324
600-003-00	311	602-606-10	309	602-832-32	320	611-115-60	324
600-004-00	311	602-800-10	322	602-833-10	320	611-116-00	324
600-005-00	311	602-800-12	322	602-833-30	320	611-120-01	324
600-300-10	300	602-800-30	322	602-834-10	321	611-122-00	324
600-300-30	300	602-800-32	322	602-834-12	321	611-130-00	324
600-300-60	300	602-801-10	322	602-834-30	321	611-131-00	324
600-301-10	301	602-801-30	322	602-834-32	321	611-132-00	324
600-301-30	301	602-806-10	318	602-835-10	321	612-000-00	324
600-301-60	301	602-806-12	318	602-835-30	321	620-107-00	293
600-302-10	302	602-806-30	318	602-836-10	315	620-108-00	293
600-302-30	302	602-806-32	318	602-836-12	315	620-109-00	293
600-302-60	302	602-808-10	322	602-836-30	315	620-110-00	293
600-303-10	303	602-808-12	322	602-836-32	315	620-207-02	293
600-303-30	303	602-808-30	322	602-837-10	316	620-208-02	293
600-303-60	303	602-808-32	322	602-837-12	316	620-209-02	293
600-310-30	304	602-809-10	318	602-837-30	316	620-708-00	293
600-320-10	300	602-809-12	318	602-837-32	316	621-028-01	292
600-320-30	300	602-809-30	318	602-838-10	315	621-031-01	292
600-320-60	300	602-809-32	318	602-838-12	315	621-034-01	292
600-321-10	301	602-810-10	319	602-838-30	315	621-037-01	292
600-321-30	301	602-810-12	319	602-838-32	315	621-040-01	292
600-321-60	301	602-810-30	319	602-839-10	316	621-043-01	292
600-322-10	302	602-810-32	319	602-839-12	316	621-046-01	292
600-322-30	302	602-811-10	323	602-839-30	316	621-200-01	293
600-322-60	302	602-811-12	323	602-839-32	316	621-300-01	293
600-400-10	303	602-811-30	323	602-840-10	322	621-404-01	292
600-400-30	303	602-811-32	323	602-840-30	322	621-405-01	292
600-500-10	306	602-812-10	323	603-000-00	312	621-406-01	292
600-500-30	306	602-812-30	323	606-600-00	310	621-407-01	292
600-500-60	306	602-815-10	317	606-600-30	310	621-408-01	292
600-501-10	306	602-815-12	317	606-701-00	310	621-409-01	292
600-501-30	306	602-815-30	317	606-701-30	310	621-500-01	292
600-501-60	306	602-815-32	317	607-202-00	294	681-100-00	169, 215, 378

REF	Page
766-000-00	292
831-601-00	282
831-603-00	282
831-606-00	282
831-701-00	282
831-703-00	282
903-920-10	399
903-920-20	399
903-920-30	399
903-920-40	399
907-037-10	378
907-047-10	378
989-474-20	396

Concept/Layout

Advertising department Dentaureum

Catalog No. 23

989-771-00

In the interest of technical improvement, we reserve the right to make changes to the design, dimensions and material of our products. It is prohibited to make copies of this catalog or parts thereof without our explicit consent. Registered design.

© Copyright Dentaureum GmbH & Co. KG

Image credits:

- © Christian Ferrari® – p. 5, 19, 124
- © Rainer Semsch® – p. 144/Image, right
- © Aamon – p. 416/Image, right
- © anson tsui / Fotolia.com – p. 352/353
- © DamienGeso / Fotolia.com – p. 122/123
- © Jezper / Fotolia.com – Back cover
- © Kuzmick / Fotolia.com – p. 9
- © Max Krasnov / Fotolia.com – p. 198
- © psdesign1 / Fotolia.com – p. 194
- © Rido / Fotolia.com – p. 10, 413
- © Stefan Körber / Fotolia.com – p. 416/Image, left
- © Viktoriya Sukhanova / Fotolia.com – p. 194/195
- © wajan / Fotolia.com – p. 417

Dentaurum Group

Germany | Benelux | España | France | Italia | Switzerland | Australia | Canada | USA
and in more than 130 countries worldwide.



DENTAURUM
QUALITY
WORLDWIDE
UNIQUE



www.dentaurum.com



Date of information: 01/19
Subject to modifications

D
DENTAURUM

Turnstr. 31 | 75228 Ispringen | Germany | Phone +49 72 31/803-0 | Fax +49 72 31/803-295
www.dentaurum.com | info@dentaurum.com